

TABLES
LIGHTING
COMPLEMENTS

PRICELIST
DESIGN SOLUTIONS

Valid from 1st February 2023

MAZUVO AG

€ = CHF
+8.1% MWST

2023

PEDRALI®

PEDRALI®

Tables, table bases, tops, complements and lighting index

Indice tavoli, basamenti, ripiani, complementi e lampade

TABLES AND TABLE BASES / BASAMENTI E TAVOLI

Aero	019	Matrix	084
Arki-Base	106	More	087
Arki-Desk	042	Nolita	153
Arki-Table	020	Oliva	154
Babila	047	Parenthesis	088
Blume	051	Plano	090
Bold	107	Quadra	155
Buddy	054	Serif	092
Buddyhub desk	059	Side Table	093
Caementum	060	Snow - Snow junior	092
Circuit	061	Space	094
Code	063	Stylus	158
Concrete	111	Surface	094
Elinor	065	Toa	095
Elliot	068 - 112	Togo	103
Exteso	069	Tonda	160
Fabbrico	069	Venice	165
Florence	165	Verona	166
Fluxo	115	Ypsilon	166
Ikon	070 - 117	Ypsilon Tilting	104
Inox	073 - 121	Ypsilon 4	168
Jump	076		
Krystal	147		
Kuadro	077	Fittings / Accessori	172
Laja	148	Finishes / Finiture	280
Liberty	150		
Lunar	152		
Magic	080		
Malmö	081		

TOPS / RIPIANI

Composite marble / Agglomerato di marmo	212
Fenix®	176
Granite / Granito	214
Gres	208
Laminate / Laminato	188
Linoleum	203
Marble / Marmo	210
Melamine / Nobilitato	204
Quartz stone / Quarzo	209
Solid laminate / Stratificato	179
Stainless steel / Inox	205
Steel / Lamiera	206
Tempered glass / Vetro temperato	207
Fittings / Accessori	215

COMPLEMENTS AND LIGHTING / COMPLEMENTI E LAMPADE

Blume System	216
Boxie	218
Brik	225
Colette - Colette 50	246
Flag	220
Giravolta	247
Happy Apple	248
Hevea	224
Iceberg	234
Igloo	235
Inox	233
Isotta	250
Kado	226
L001	251
L002	268
L004	273
Oblique	239
Ray	222
Snooze	227
Tamara	277
Tetris	243
Time Out	278
Toa Folding Screen	228
To.Be	279
Voilà	223
Wow	219
Ypsilon Connect	229
Finishes / Finiture	280
Fabrics / Tessuti	284

Condizioni generali di vendita e garanzia

AMBITO DI APPLICAZIONE

Le presenti condizioni generali disciplinano tutti gli attuali e futuri rapporti tra Pedrali Spa ed il compratore, salvo eventuali deroghe specificatamente concordate per iscritto.

PREZZI

I prezzi sono espressi in euro e sono Iva esclusa. Tutti i prezzi non comprendono dazi, tasse, imposte e spese di trasporto.

VALIDITÀ PREZZI

Il presente listino prezzi ha validità dal 1 Febbraio 2023 sino a nuova comunicazione.

Qualunque offerta o proposta comunicata da agenti o da terzi e non formalizzata direttamente da Pedrali Spa, sarà valida solo quando verrà approvata per iscritto dall'azienda. Le offerte emesse da Pedrali Spa hanno validità un mese dalla data di emissione, dopodiché l'azienda si riserva di rimettere una nuova offerta.

ORDINE MINIMO

Importo minimo di ogni ordine 400,00 euro netti.

Qualsiasi ordine di importo inferiore a 400,00 euro netti non è da ritenersi accettato fino a conferma scritta da parte di Pedrali Spa.

ACCETTAZIONE ORDINI

Si considerano validi solamente gli ordini ricevuti direttamente dal compratore.

Qualunque offerta o proposta comunicata da agenti o da terzi e non formalizzata direttamente da Pedrali Spa, è da ritenersi valida solo quando approvata per iscritto dall'azienda.

Per qualunque ordine di prodotti speciali non contemplati all'interno del presente listino deve essere fatta specifica richiesta. Pedrali Spa si riserva di valutarne la fattibilità, senza alcun impegno.

Gli ordini sono sempre subordinati all'accettazione di Pedrali Spa che si riserva la facoltà di rifiutarli entro 30 gg dalla ricezione.

In caso di richiesta della firma per accettazione da parte del compratore, l'ordine si considererà tale a partire dalla ricezione della conferma d'ordine firmata.

In caso di richiesta dell'acconto, l'ordine si considererà tale dalla ricezione dell'acconto.

MODIFICHE DI ORDINE

Sono da considerarsi modifiche eventuali riduzioni di quantità o modifica di articolo.

Aggiunte di quantità si considerano nuovi ordini che decorreranno dalla ricezione del nuovo ordine.

L'azienda prende in considerazione solo modifiche di ordini effettuate entro 48 ore dalla ricezione degli stessi.

Previa valutazione, Pedrali Spa comunicherà se possibile accettare tali modifiche.

I tempi di consegna decorreranno dalla data della modifica.

Non si potrà accettare, in ogni caso, più di una modifica per ordine.

Eventuali modifiche di indirizzi di consegna successive all'invio della conferma d'ordine prevedono un addebito di costi amministrativi di 200,00 euro netti.

ANNULLAMENTO ORDINE

È possibile annullare l'ordine entro 48 ore dalla ricezione della conferma d'ordine di Pedrali Spa. In seguito, l'annullamento non sarà più possibile.

Qualora il compratore dovesse, in ogni caso, per qualunque ragione dichiarare annullato l'ordine successivamente a tale fase, ovvero intendesse recedere dal contratto revocando l'ordine, eventuali acconti versati saranno trattenuti da Pedrali Spa a titolo di risarcimento danni, con diritto della stessa a richiedere al compratore ulteriori costi e spese sostenute per la produzione.

TEMPI DI CONSEGNA

I tempi di consegna sono indicativi; il compratore non potrà pretendere né l'annullamento totale o parziale dell'ordine, né il rimborso di danni nel caso di ritardi di consegne.

In caso di richiesta della firma per accettazione del compratore sulla conferma d'ordine, o di richiesta di acconto, i tempi di consegna

decorrono dalla data di ricezione degli stessi.

Per ordini ricevuti incompleti o contenenti prodotti in finiture, misure o varianti non appropriati, la data di consegna decorre dal momento in cui viene confermata la ricezione di informazioni complete e corrette.

Nel caso di imbottiti con tessuto cliente, i tempi di consegna decorrono dalla ricezione del tessuto e dalla conferma di fattibilità.

Nel caso di tinte a campione, i tempi di consegna decorrono dalla ricezione del campione.

MONTAGGIO E INSTALLAZIONE

I prodotti possono essere consegnati smontati. Il montaggio e l'installazione sono a carico del compratore e devono essere eseguiti da montatori specializzati, seguendo le istruzioni di montaggio fornite da Pedrali Spa.

IMBALLO

I nostri imballi sono adatti per trasporto a mezzo camion.

Eventuali imballi per trasporto via aerea devono essere specificati al momento dell'ordine. Il supplemento per l'imballo speciale è di 200,00 euro netto per ordine, cui si aggiungono 40,00 euro lordi a bancale.

La merce disposta su bancali non può essere sbancalata. I bancali non possono essere sovrapposti.

I cartoni sfusi devono essere movimentati sempre mantenendo il lato alto indicato sul cartone.

Per sedie/sgabelli con imballo standard multiplo è possibile richiedere imballo singolo, ove possibile, con un supplemento di 7,00 euro lordo (IVA esclusa) a pezzo.

In caso di richiesta di pallet conforme alla normativa FAO ISPM 15, la richiesta deve essere avanzata al momento dell'ordine e prevede un supplemento di 40,00 euro lordi per ogni pallet.

PRODOTTI PER UTILIZZO ALL'ESTERNO

Solo i prodotti contrassegnati dall'apposito simbolo, sono garantiti per utilizzo all'esterno.

Verande, piscine, centri termali, navi e location in prossimità dal mare, sono considerati ambienti esterni anche se non esposti direttamente a sole, pioggia e salsedine.

Si consiglia un rimessaggio protetto nel periodo di non utilizzo.

RESA DELLA MERCE

La merce è venduta EX WORKS e viaggia a rischio e pericolo del committente.

Eventuali prezzi DAP/DDP devono essere concordati tra le parti e indicati espressamente nella conferma d'ordine.

In ogni caso nessuna responsabilità potrà essere imputata a Pedrali Spa, qualora si verificano casi di ammanco o avaria di varia natura causati durante lo stivaggio, il caricamento o il trasporto.

È nell'interesse del compratore verificare quantità e condizioni dell'imballo della merce prima del ritiro, facendo eventuali opportune riserve al corriere se necessario.

In caso di riserva, Pedrali Spa si renderà disponibile a chiedere il rimborso al corriere. In caso di assenza di riserva, Pedrali Spa declinerà ogni responsabilità. Eventuali danni devono essere comunicati entro e non oltre 8 giorni dalla ricezione della merce, e comunque prima che i prodotti vengano utilizzati.

L'indirizzo di destinazione dovrà essere quello del compratore. Nel caso il destinatario richieda la sponda idraulica, la richiesta dovrà essere avanzata al momento dell'ordine, con il costo di 130,00 euro netti.

Consegne ad un indirizzo diverso dal magazzino del compratore, devono essere concordate preventivamente tra le parti al momento dell'ordine. Devono altresì essere forniti un nominativo e un contatto telefonico del destinatario.

GARANZIA

La garanzia si applica per un periodo di 24 mesi su vizi e difetti di produzione nelle normali condizioni d'uso previste per ogni singolo prodotto.

Tale garanzia decorre dalla data di fatturazione.

La garanzia opera e si applica soltanto a condizione che:

- i prodotti siano utilizzati nell'ambito dell'uso consentito
- i prodotti siano installati da tecnici qualificati secondo le istruzioni fornite da Pedrali Spa
- i prodotti non siano stati modificati o manomessi da terzi
- i prodotti non siano stati montati/abbinati a componenti non forniti da Pedrali Spa
- i prodotti imbottiti non siano stati rivestiti con tessuti forniti dal cliente. Non viene garantita la qualità della tappezzeria con materiali non forniti direttamente da Pedrali Spa
- i prodotti siano stati mantenuti o conservati correttamente come previsto dalle istruzioni di uso e manutenzione
- i prodotti siano stati interamente pagati

RECLAMI

Ogni reclamo relativo a prodotti difettosi deve essere trasmesso per iscritto dall'acquirente direttamente a Pedrali Spa, entro 8 giorni dalla data della scoperta di vizio/difetto, pena di decadenza, con l'indicazione espressa del modello, della data di consegna, della descrizione del difetto e relative immagini, indicando anche la quantità dei prodotti difettosi.

Senza queste informazioni il reclamo non sarà considerato valido.

MODALITÀ DI ACCETTAZIONE DELLA GARANZIA

Qualora Pedrali Spa riconoscesse il vizio/difetto, potrà scegliere di sostituire/riparare i prodotti difettosi o proporre un prodotto alternativo con le medesime caratteristiche essenziali.

Qualora la riparazione o la sostituzione si rivelasse impossibile o superasse il costo del valore dei prodotti difettosi, Pedrali Spa potrà recedere dal contratto accettando il reso della merce con trasporto a carico dell'acquirente e rimborsando il prezzo di acquisto (spese di trasporto, installazione escluse).

Pedrali Spa non accetta altri tipi di penali o rimborsi spese.

RESI

Non si accettano resi di merce senza preventiva autorizzazione scritta da Pedrali Spa, la quale, in assenza di questa, si riserva il diritto di respingere la merce al mittente.

I resi di merce autorizzata devono essere inviati in porto franco, in perfetto stato e con imballo originale. In caso contrario Pedrali Spa si riserva il diritto di addebitare al compratore i costi sostenuti per la riparazione e la sostituzione dell'imballo.

La merce per la quale il reso è stato autorizzato sarà accreditata al costo di acquisto e gravata dal rimborso spese nella misura convenzionale del 20%.

PRODOTTI IGNIFUGHI

Eventuali certificazioni di reazione a fuoco devono essere richieste al momento dell'ordine, non possono essere richieste successivamente alla conferma d'ordine.

MODIFICHE DI PRODOTTI

Pedrali Spa si riserva il diritto di apportare in ogni momento, a suo insindacabile giudizio e senza necessità di preavviso, migliorie o modifiche ai propri prodotti.

Le descrizioni, illustrazioni, dati tecnici contenuti in cataloghi, listini, sito, ecc. di Pedrali Spa non hanno carattere vincolante.

PAGAMENTI

I pagamenti devono essere indirizzati direttamente a Pedrali Spa, salvo diverse indicazioni sulla conferma d'ordine.

RISERVA DI PROPRIETÀ

La proprietà dei prodotti rimarrà di Pedrali Spa fino a quando non verrà effettuato l'intero pagamento del relativo importo.

LEGGE APPLICABILE-CONTROVERSIE

Per quanto non previsto nelle presenti condizioni si applica la legge italiana.

Per qualsiasi controversia è esclusivamente competente il Foro di Bergamo.

DISCLAIMER

Pedrali Spa declina ogni responsabilità per danni a cose e persone causati da utilizzo improprio del prodotto, anche derivanti da una destinazione d'uso non preventivamente comunicataci e approvata da parte di Pedrali Spa.

General terms and conditions of sale and warranty

SCOPE OF APPLICATION

These present general conditions govern all current and future relationships between Pedrali Spa and the buyer, except for any exceptions specifically agreed upon in writing.

PRICES

Prices are expressed in euro, VAT excluded. All prices do not include tariffs, taxes, fees and shipping costs.

PRICE VALIDITY

This price list is valid from 1 February 2023 until further notice.

Any offer or proposal communicated by agents or third parties and not formalized directly by Pedrali Spa shall be valid only when it is approved in writing by the company. The offers issued by Pedrali Spa are valid for one month from the date of issue, after which the company reserves the right to issue a new offer.

MINIMUM ORDER

The minimum amount of each order is 400,00 euro, net of VAT.

Any order of an amount less than 400,00 euro (net of VAT) shall not be considered accepted until written confirmation is provided by Pedrali Spa.

ORDER ACCEPTANCE

Orders shall only be considered valid if they are received directly from the buyer.

Any offer or proposal communicated by agents or third parties and not formalized directly by Pedrali Spa shall be considered valid only when its approved in writing by the company.

Any order of special products not included in this price list must be the subject of a specific request. Pedrali Spa reserves the right to evaluate their feasibility, without any obligation.

Orders are always subject to acceptance by Pedrali Spa, that reserves the right to refuse them within 30 days of receipt.

In the event the buyer's signature is requested for acceptance, the order shall be considered concluded only upon receipt of the signed order confirmation.

In the event a down payment is requested, the order shall be considered concluded upon receipt of the payment.

ORDER CHANGES

Any reductions in quantity or changes in articles are to be considered as changes to the order.

Added quantities shall be considered new orders, with times calculated from receipt of the new order.

The company shall only consider order changes made within 48 hours of receipt of the orders.

Subject to the evaluation of the request, Pedrali Spa shall communicate whether it is possible to accept the changes.

Delivery times shall be calculated from the date of the change.

In any event, no more than one change is permitted per order.

Any changes to the delivery address after the transmission of the order confirmation shall entail a charge of 200,00 euro (net of VAT) for administrative costs.

ORDER CANCELLATION

Orders may be cancelled within 48 hours of receipt from the order confirmation by Pedrali Spa. Subsequently, cancellation will no longer be possible.

If the buyer, in any event and for any reason whatsoever, declare the cancellation of the order after such time, or intend to withdraw from the contract and revoke the order, any down payments shall be withheld by Pedrali Spa as compensation for damages. Pedrali Spa also reserves the right to request additional costs and expenses sustained for production from the buyer.

DELIVERY TIMES

Delivery times are indicative; the buyer may not claim the total or partial cancellation of the order, nor reimbursement for damages in the case of delivery delays.

In the event the buyer's signature is requested on the order confirmation, or a down payment is requested, the delivery times shall be calculated from receipt of the same.

For orders that are incomplete when received or improperly indicate the finishings, measurements or versions of the products, the delivery date shall be calculated from the receipt of complete or correct information.

In the case of upholstery with the client's fabric, the delivery times shall be calculated from receipt of the fabric and confirmation of feasibility. In the case of colors based on a sample, the delivery times shall be calculated from the receipt of the sample.

ASSEMBLY AND INSTALLATION

The products may be delivered disassembled. Assembly and installation are the responsibility of the buyer and must be performed by specialized assemblers, following the assembly instructions provided by Pedrali Spa.

PACKAGING

Our packaging materials are suitable for transport by truck.

Any packaging for air transport must be specified at the time of the order. The supplement for special packaging is 200,00 euro per order (net of VAT), to which 40,00 euro shall be added per pallet.

Goods arranged on pallets may not be depalletized. Pallets may not be stacked.

Loose boxes must always be handled with the correct side up.

For chairs/stools with multiple standard packaging, it is possible to request single packaging, where possible, with a supplement charge of gross 7,00 euro per item.

In the case of requests for pallets compliant with FAO ISPM 15 standards, the request shall be made at the time of the order, and entail a supplement charge of gross 40,00 euro per pallet.

PRODUCTS FOR EXTERNAL USE

Only products marked with the specific symbol are guaranteed for external use.

Verandas, pools, spas, ships and locations near the sea are considered external environments even if they are not directly exposed to the sun, rain and sea salt.

Products must be stored in a protected area when not in use as recommended.

DELIVERY TRADE TERMS

Goods are sold EX WORKS and shipping is at the risk and peril of the client.

Any DAP/DDP prices must be agreed upon by the parties and expressly indicated in the order confirmation.

In any event, no liability may be attributed to Pedrali Spa in the event of any shortages or problems of any kind caused during stowage, loading or shipping.

It is the buyer's responsibility to verify the quantity and conditions of the packaged goods before receipt, indicating any appropriate reservations to the courier where necessary.

In the event of reservations, Pedrali Spa shall request reimbursement from the courier. In the absence of any reservations, Pedrali Spa shall decline any liability.

Any damages must be notified by no later than 8 days of receipt of the goods and in any event before the products are used.

The delivery address must be that of the buyer.

In the event the recipient requests a tail lift, the request must be made at the time of the order, with a cost of 130,00 euro (net of VAT).

Deliveries to an address other than the buyer's warehouse must be agreed upon in advance between the parties at the time of the order. A name and telephone number of the recipient must also be provided.

WARRANTY

The warranty applies for a period of 24 months on production flaws and defects in normal conditions of use for each single product.

The warranty applies from the invoice date.

The warranty shall apply subject to the following conditions:

- the products are used in the permitted area of use
- the products are installed by qualified technicians following the instructions provided by Pedrali Spa
- the products have not been modified or altered by third parties
- the products have not been assembled/combined with components not supplied by Pedrali Spa
- Upholstered products have not been covered with fabric supplied by the client. No warranty is provided for the quality of upholstery with materials not supplied directly by Pedrali Spa
- the products have been maintained or preserved properly as indicated by the instructions for use and maintenance
- the products have been paid for in full

COMPLAINTS

Any complaints relating to defective products must be notified in writing by the buyer directly to Pedrali Spa within 8 days of the date the flaw/defect is discovered, on penalty of forfeiture, expressly indicating the model, delivery date, a description of the defect and the respective images, and also indicating the quantity of defective products.

Without such information, the complaint shall not be considered valid.

METHOD OF ACCEPTANCE OF WARRANTY

If Pedrali Spa acknowledges the flaw/defect, it may choose to replace/repair the defective products or offer an alternative product with the same essential characteristics.

Should repair or replacement turn out to be impossible or exceed the value of the defective products, Pedrali Spa may withdraw from the contract accepting the return of the goods with shipping costs covered by the buyer and reimbursing the purchase price (shipping costs and installation excluded).

Pedrali Spa shall not accept any other types of liabilities or penalties or expense reimbursements.

RETURNS

The return of goods shall not be accepted without written authorization from Pedrali Spa, which in the absence of such authorization, reserves the right to reject the goods from the sender.

Authorized returns of goods must be sent with carriage paid, in perfect condition and in the original packaging. In the absence of such conditions, Pedrali Spa reserves the right to charge the buyer for the costs sustained for the repair and replacement of the packaging.

The goods for which return has been authorized shall be credited at the purchase cost and subject to expense reimbursement at the conventional rate of 20%.

FIREPROOF PRODUCTS

Any reaction-to-fire certifications must be requested at the time of the order, and cannot be requested after order confirmation.

PRODUCT ALTERATIONS

Pedrali Spa reserves the right to make improvements or alterations to its products at any time, at its sole discretion and without the need to provide advance notice.

The descriptions, illustrations and technical data contained in the Pedrali Spa catalogues, price lists, website, etc. shall not be binding.

PAYMENTS

Payments must be sent directly to Pedrali Spa, unless otherwise indicated on the order confirmation.

RETENTION OF TITLE

Pedrali Spa remains the proprietor of the products until full payment is made of any respective amounts.

APPLICABLE LAW-DISPUTES

Any matters not covered by these conditions shall be subject to the laws of Italy.

Any disputes shall be under the exclusive jurisdiction of the Courts of Bergamo.

DISCLAIMER

Pedrali Spa accepts no responsibility for damages to things and people caused by an improper use of the product, also arising from an intended use, not previously notified to and approved by Pedrali Spa.

Legend

Legenda

/AC	Table base with brushed stainless steel column / Basamento con tubo in acciaio inox satinato
/LU	Table base with polished stainless steel column / Basamento con tubo in acciaio inox lucidato
/CR	Table base with chromed column / Basamento con tubo cromato
/ST	Table base with satinized column / Basamento con tubo satinato
/EC	Table base with corten column / Basamento con tubo effetto corten
/OA	Table base with antique brass column / Basamento con tubo ottonato anticato
/RM	Table base with antique copper column / Basamento con tubo rame anticato
/BS	Table base with antique bronze column / Basamento con tubo bronzo anticato
/TN	Table base with titanium column / Basamento con tubo effetto titanio
/AS	Table base with brushed aluminium column / Basamento con tubo in alluminio spazzolato
/AA	Table base with anodized aluminium column / Basamento con tubo in alluminio anodizzato
/RV	Table base with oak veneered tube / Basamento con tubo impiallacciato rovere
/FX	Table base with solid beech column and stainless steel band / Basamento con colonna in faggio massiccio e fascia in acciaio inox
/FM	Table base with solid beech column / Basamento con colonna in faggio massiccio
REG	Table base with adjustable feet / Basamento con piedini regolabili

Important

Prices of table bases do not include table tops.

All table bases include a cross for the top fixing.

The stainless steel plate is supplied with glass top only.

Importante

I prezzi dei basamenti non comprendono i ripiani.

Tutti i basamenti includono la crociera per il fissaggio del ripiano.

Le piastre in acciaio inox vengono fornite solamente con i ripiani in vetro.

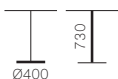

All dimensions are in millimeters

Tutte le dimensioni sono espresse in millimetri



Max matching top size. Valid for Fenix®, Solid laminate, Laminate, Linoleum, Melamine, Veneered, Solid oak, Stainless steel, Steel, Polyethylene and Teak tops.

Dimensione ripiano max abbinabile. Valido per ripiani in Fenix®, Stratificato, Laminato, Linoleum, Nobilitato, Impiallacciati, Rovere massello, Inox, Lamiera, Polietilene, Teak



Number of pieces per box and volume of carton in cubic meters

Numero di pezzi contenuti nell'imballo e volume in metri cubi del cartone

KD

Disassembled product

Prodotto da assemblare



Number of cartons per pallet

Numero di cartoni contenuti su pallet



Weight of a single product in Kgs

Peso del singolo prodotto espresso in chilogrammi



Product suitable for outdoor use

Prodotto adatto per utilizzo in esterni



Product not recommended for outdoor use

Prodotto non adatto per utilizzo in esterni

Outdoor table bases and tables / Basamenti e tavoli per esterno



CONCRETE



IKON



LAJA



YPSILON



YPSILON 4



INOX
4421/AC316



TONDA
4151/AC316



ARKI-BASE



NOLITA



ELLIOT



VENICE



FLORENCE



VERONA



BOLD



QUADRA



TONDA



SERIF



TOA



ARKI-TABLE



ARK5



BABILA table



CAEMENTUM

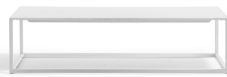

CODE



BUDDY



CIRCUIT



FABBRICO



MATRIX



JUMP



TOGO



SNOW - SNOW jr

Outdoor table tops / Ripiani per esterno



Solid laminate / Stratificato



COI/COM/COP

CFC/CFT/CFP

Steel - Stainless steel / Lamiera - Acciaio inox



LAMIERA



INOX

Gres



WFN - GFN - IDN

Quartz / Quarzo



QRZ

Marble / Marmo



MBC

Composite marble / Agglomerato di marmo



MFP - MBR - MPR - MRL

Granite / Granito



GNA

Coffee tables / Tavolini



LAJA 5420 H400, 5430 H400
TONDA 4153, 4533, 4553
INOX 4402H
INOX 4903
INOX 4402 H500, 4401 H500
IKON 863, 863V
QUADRA 41 63, 4563, 4573
WOW 470, 480, 486
SIDE-TABLE



CODE
MALMÖ
PARENTHESIS
SNOW JR
BOLD 4752 H500, 4758 H500, 4759 H500, 4757 H500, 4753
STYLUS 5403, 5413, 5402 H500
CONCRETE 855 H500



CAEMENTUM
CIRCUIT
BUDDY
BLUME
LUNAR 5443



YPSILON 4793, 4793V
YPSILON 4 4795 H500, 4795V H500, 4797 H500, 4797V H500
NOLITA 5453 H480
INOX 4400 H500, 4413, 4412 H500, 4423, 4433, 4443, 4463, 4452 H500, 4462 H500, 4467 H500, 4473, 4472 H500, 4475 H500, 4493, 4492 H500
ELLIOT 5473, 5475 H500, 5477 H500
FLUXO 5463, 5465 H500

Poseur tables / Tavoli alti



CONCRETE
855 HT100



TONDA
4154, 4154R,
4534, 4554



QUADRA
4164, 4564,
4574



STYLUS
5404



BOLD
4754, 4756



YPSILON
4794, 4794T



IKON
867, 868



INOX
4404, 4406, 4414, 4414R,
4424, 4434, 4444, 4456,
4464, 4466, 4474, 4494



INOX
4406H



LAJA
5424, 5434



LUNAR
5444



ELLIOT
5474, 5474T,
5476



FLUXO
5484, 5486



ARKI-BASE
ARK4HT05



SERIF
861



ARKI-TABLE
ARK107

Wooden column table bases / Basamenti con colonna in legno



INOX

4401/FX, 4411/FX, 4413/FX, 4414/FX, 4421/FX, 4423/FX, 4424/FX, 4431/FX, 4433/FX, 4434/FX, 4441/FX, 4443/FX, 4461/FX, 4462/FX, 4463/FX, 4464/FX, 4471/FX



INOX

4402/RV, 4410/RV, 4420/RV, 4430/RV, 4460/RV, 4462/RV, 4472/RV, 4475/RV, 4492/RV, 4499/RV



INOX

4481/FM, 4482/FM



TONDA

4150/RV, 4530/RV, 4550/RV



OLIVA

Table bases with adjustable feet / Basamenti con piedini regolabili

STANDARD



YPSILON 4



LAJA



STYLUS



INOX

4430/REG, 4431/REG, 4433/REG, 4434/REG, 4437/REG, 4470/REG, 4471/REG, 4472/REG, 4473/REG, 4474/REG, 4475/REG, 4497/REG, 4499/REG



BOLD



ELLIOT

5475, 5475 H500, 5476, 5477, 5477 H500



FLUXO

5465, 5465 H500, 5466



VENICE



FLORENCE



VERONA

ON DEMAND / A richiesta



INOX

4401, 4401 H500, 4402, 4402 H500, 4404, 4406, 4411, 4412, 4412 H500, 4413, 4414, 4421, 4423, 4424, 4441, 4443, 4444, 4452, 4452 H500, 4456, 4461, 4462, 4462 H500, 4463, 4464, 4466, 4467, 4467 H500, 4481, 4482, 4491, 4492, 4492 H500, 4493, 4494, 4901, 4903



KRYSZAL

4401/KR, 4411/KR, 4421/KR, 4431/KR



TONDA

4150, 4151, 4153, 4154, 4530, 4533, 4534, 4550, 4551, 4553, 4554



LIBERTY

4200, 4210, 4230, 4220



OLIVA

4150/OL, 4151/OL, 4550/OL, 4551/OL



QUADRA

4160, 4163, 4164, 4560, 4563, 4564, 4570, 4573, 4574

AERO

Fixed tables / Tavoli fissi



Item Articolo	Frame Telaio Sizes Dimensioni	Finish Finitura	Solid laminate top included Incluso ripiano in stratificato				Glass top included Incluso ripiano in vetro
			CFC_BI (mm 10)	FNP_NE (mm 10)	FNP_3452 (mm 10)	FNP_3455 (mm 10)	FUM (mm 12)
TAE_130X130	1300X1300	BI300	€ 2.049,00	-	-	€ 2.594,00	-
		NERO	-	€ 2.182,00	€ 2.264,00	-	€ 2.808,00
TAE_220X106	2200X1060	BI300	€ 2.248,00	-	-	€ 3.074,00	-
		NERO	-	€ 2.413,00	€ 2.578,00	-	€ 3.074,00



TECHNICAL DETAILS / Dettagli tecnici

Item TAE_130X130

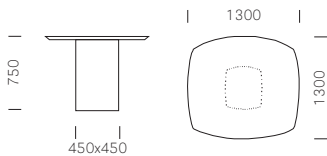

Item TAE_220X106

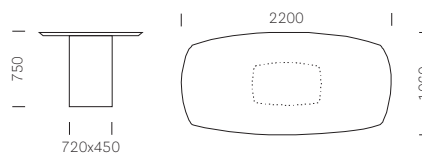

Frame finishes Finiture telaio



Solid laminate top finishes Finiture ripiano in stratificato

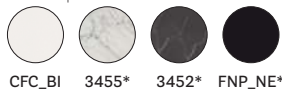

*Anti-fingerprint finish
Finitura anti-impronta

Glass top finish Finitura ripiano in vetro



ARKI-TABLE - Compact

Fixed tables / Tavoli fissi



Item Articolo	Frame Telaio		Solid laminate top included Incluso ripiano in stratificato					
	Sizes Dimensioni	Finish Finitura	CFC_BI (mm 6) white core anima bianca	COM 527, 234, 623 (mm 6) 527, 234, 623 core/anima	COM 2810 (mm 12) black core anima nera	COM 4511, 4512, 4517, 4519 (mm 10) brown core anima marrone	COM 4529, 1952 (mm 10) black core anima nera	COM 4543 (mm 10) brown core anima marrone
ARK200X100	2000X1000	Powder coated Verniciato	€ 1.653,00	€ 1.888,00	€ 1.888,00	€ 1.888,00	€ 1.888,00	€ 2.045,00
ARK240X100	2400X1000		€ 1.731,00	€ 2.298,00	€ 2.298,00	€ 2.298,00	€ 2.298,00	€ 2.455,00
ARK240X120	2400X1200		€ 1.841,00	€ 2.408,00	€ 2.408,00	€ 2.408,00	€ 2.408,00	€ 2.565,00
ARK300X100	3000X1000		€ 2.125,00	€ 2.534,00	€ 2.534,00	€ 2.534,00	€ 2.534,00	€ 2.691,00
ARK300X120	3000X1200		€ 2.203,00	€ 2.612,00	€ 2.612,00	€ 2.612,00	€ 2.612,00	€ 2.769,00
ARK360X120	3600X1200		€ 2.597,00	€ 2.989,00	€ 2.989,00	€ 2.989,00	€ 2.989,00	€ 3.146,00

TECHNICAL DETAILS / Dettagli tecnici



Prices refer to combinations provided for the pricelist. Other standard powder-coated finishes available on request, price surcharge € 158,00 (each table)
I prezzi si riferiscono alle combinazioni previste a listino. Disponibili a richiesta altri colori standard di verniciatura, supplemento € 158,00 (a tavolo)

Top, frame and frame top finishes Finiture ripiano, telaio e cornice

Table top Ripiano												
	CFC_BI	4519	527	4511	234	623	2810	4543	4529	1952	4512	4517
Frame Telaio												
	BI100	BE100	BE200	GA	MG	NERO						
Frame under the top Telaio sotto il ripiano												
	BI100	BI100	BI100	NERO	MG	NERO						

ARKI-TABLE - Outdoor



VAT NOT INCLUDED / Iva esclusa

Tables / Tavoli

Fixed tables / Tavoli fissi



Frame Telaio			Solid laminate top included Incluso ripiano in stratificato					
Item Articolo	Sizes Dimensioni	Finish Finitura	CFC_BI (mm 6) white core anima bianca	COM 527 (mm 6) 527 core/anima COM 2810 (mm 12) black core anima nera	COM 4519 (mm 10) brown core anima marrone COM 4529, 1952 (mm 10) black core anima nera	CFP 3445 (mm 10) matching core anima in tinta	CFP 3447 (mm 10) matching core anima in tinta	COM 3471 (mm 10) beige core anima beige
ARK200X100	2000X1000	Powder coated Verniciato	€ 1.810,00	€ 2.045,00	€ 2.045,00	€ 2.282,00	€ 2.125,00	€ 2.439,00
ARK240X100	2400X1000		€ 1.888,00	€ 2.455,00	€ 2.455,00	€ 2.470,00	€ 2.313,00	€ 3.494,00
ARK240X120	2400X1200		€ 1.999,00	€ 2.565,00	€ 2.565,00	€ 2.550,00	€ 2.392,00	€ 3.603,00
ARK300X100	3000X1000		€ 2.282,00	€ 2.691,00	€ 2.691,00	€ 2.911,00	€ 2.754,00	€ 3.729,00
ARK300X120	3000X1200		€ 2.360,00	€ 2.769,00	€ 2.769,00	€ 2.989,00	€ 2.832,00	€ 3.808,00
ARK360X120	3600X1200		€ 2.754,00	€ 3.146,00	€ 3.146,00	€ 3.540,00	€ 3.383,00	€ 3.855,00

TECHNICAL DETAILS / Dettagli tecnici



Prices refer to combinations provided for the pricelist. Other standard powder-coated finishes available on request, price surcharge € 158,00 (each table)
I prezzi si riferiscono alle combinazioni previste a listino. Disponibili a richiesta altri colori standard di verniciatura, supplemento € 158,00 (a tavolo)

Top, frame and frame top finishes Finiture ripiano, telaio e cornice



ARKI-TABLE - Outdoor



Fixed tables / Tavoli fissi

VAT NOT INCLUDED / Iva esclusa

Tables / Tavoli



Frame Telaio			Composite marble top included Incluso ripiano in agglomerato di marmo		Gres top included Incluso ripiano in gres	
Item Articolo	Sizes Dimensioni	Finish Finitura	MFP (mm 12)	MBR (mm 12)	WFN, GFN (mm 6)	IDN (mm 6)
ARK200X100	2000X1000	Powder coated Verniciato	€ 3.210,00	€ 3.367,00	€ 2.915,00	€ 3.072,00
ARK240X100	2400X1000		€ 3.494,00	€ 3.651,00	€ 3.058,00	€ 3.215,00
ARK300X100	3000X1000		€ 3.871,00	€ 4.028,00	-	-

TECHNICAL DETAILS / Dettagli tecnici



Prices refer to combinations provided for the pricelist. Other standard powder-coated finishes available on request, price surcharge € 158,00 (each table)
I prezzi si riferiscono alle combinazioni previste a listino. Disponibili a richiesta altri colori standard di verniciatura, supplemento € 158,00 (a tavolo)

Top, frame and frame top finishes Finiture ripiano, telaio e cornice

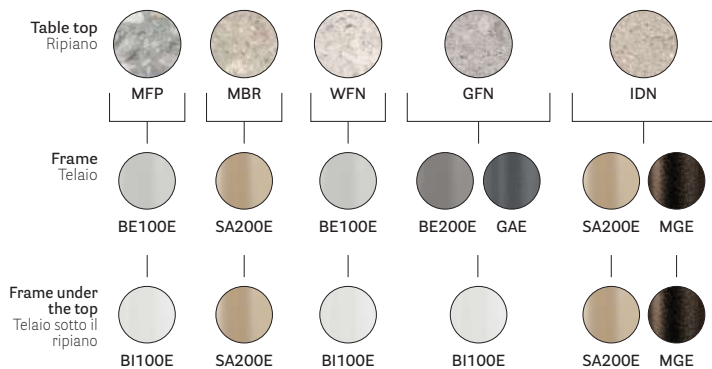

ARKI-TABLE - Fenix®

Fixed tables / Tavoli fissi



Frame Telaio			Solid laminate top included Incluso ripiano in stratificato			
Item Articolo	Sizes Dimensioni	Finish Finitura	FMP_NE (mm 12) plywood core anima in multistrati	FNP_NE (mm 6) black core anima nera	FNP_3452 (mm 6) black core anima nera	FNP_3455 (mm 6) white core anima bianca
ARK200X100	2000X1000	Powder coated Verniciato	€ 1.731,00	€ 1.888,00	€ 1.967,00	€ 2.439,00
ARK240X100	2400X1000		€ 1.810,00	€ 2.298,00	€ 2.769,00	€ 3.494,00
ARK240X120	2400X1200		€ 2.140,00	€ 2.408,00	€ 2.880,00	€ 3.603,00
ARK300X100	3000X1000		€ 2.298,00	€ 2.534,00	€ 3.006,00	€ 3.729,00
ARK300X120	3000X1200		€ 2.565,00	€ 2.612,00	€ 3.084,00	€ 3.808,00
ARK360X120	3600X1200		-	€ 2.989,00	€ 3.146,00	€ 3.855,00

TECHNICAL DETAILS / Dettagli tecnici



Prices refer to combinations provided for the pricelist. Other standard powder-coated finishes available on request, price surcharge € 158,00 (each table)
I prezzi si riferiscono alle combinazioni previste a listino. Disponibili a richiesta altri colori standard di verniciatura, supplemento € 158,00 (a tavolo)

Top, frame and frame top finishes Finiture ripiano, telaio e cornice

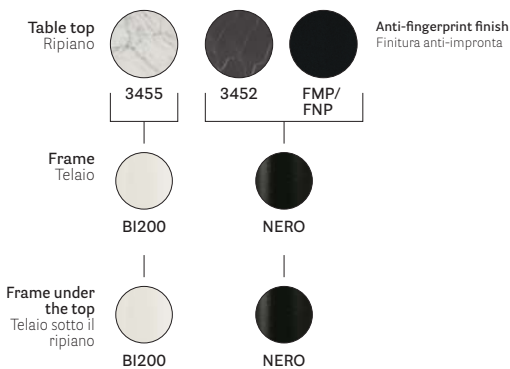

ARKI-TABLE - Linoleum

Fixed tables / Tavoli fissi



Frame Telaio		Finish Finitura	Cable management Canalina	Linoleum top included Incluso ripiano in linoleum
Item Articolo	Sizes Dimensioni			
ARK200X100	2000X1000	Powder coated Verniciato	Without cable management Senza canalina	LMP 4023, 4132 (mm 12) plywood core anima in multistrati
ARK240X100	2400X1000			€ 1.854,00
ARK240X120	2400X1200			€ 2.086,00
ARK300X100	3000X1000			€ 2.274,00
ARK300X120	3000X1200			€ 2.632,00
ARK240X120CC	2400X1200	Powder coated Verniciato	CC (42 mm) *	€ 2.970,00
ARK300X120CC	3000X1200			€ 2.589,00
				€ 3.284,00

(*) On request 60 mm width (CC60) cable management also available - same price
Disponibile a richiesta il tavolo con canalina larghezza 60 mm (CC60) allo stesso prezzo

TECHNICAL DETAILS / Dettagli tecnici

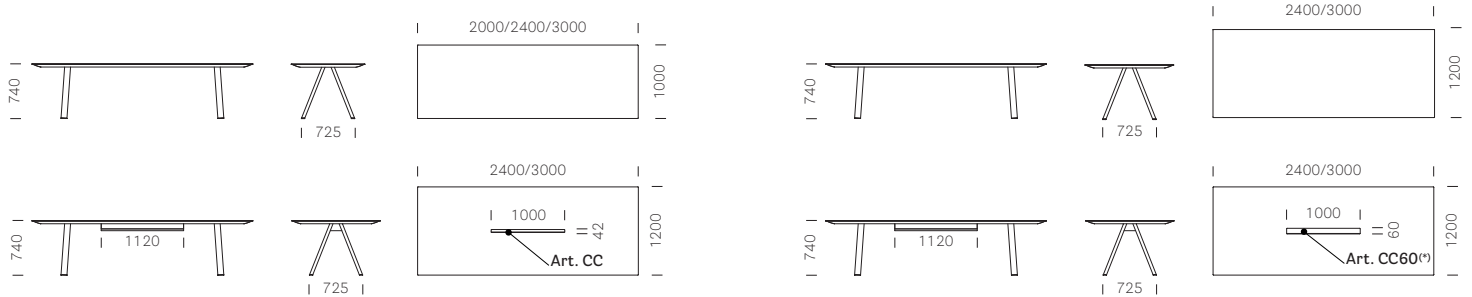

Prices refer to combinations provided for the pricelist. Other standard powder-coated finishes available on request, price surcharge € 158,00 (each table)
I prezzi si riferiscono alle combinazioni previste a listino. Disponibili a richiesta altri colori standard di verniciatura, supplemento € 158,00 (a tavolo)

Top, frame and frame top finishes Finiture ripiano, telaio e cornice

Table top
Ripiano

4132 4023

Frame
Telaio

BE200 NERO

Frame under the top
Telaio sotto il ripiano

BI100 NERO

ARKI-TABLE - Compact

Fixed tables - with cable management / Tavoli fissi - con canalina



CCO

Hole with black powder coated cable management and cover in the same material of the top.
Spacco per passaggio cavi con canalina verniciata nero e coperchio di chiusura dello stesso materiale del ripiano.



CC / CC60

Item Articolo	Sizes Dimensioni	Finish Finitura	Cable management Canalina	Solid laminate top included Incluso ripiano in stratificato					
				CFC_BI (mm 6) white core anima bianca	COM 527, 234, 623 (mm 6) 527, 234, 623 core/anima	COM 2810 (mm 12) black core anima nera	COM 4511, 4512, 4517, 4519 (mm 10) brown core anima marrone	COM 4529, 1952 (mm 10) black core anima nera	COM 4543 (mm 10) brown core anima marrone
ARK240X120CC	2400X1200	Powder coated Verniciato	CC (42 mm) *	€ 2.156,00	€ 2.723,00	€ 2.723,00	€ 2.723,00	€ 2.723,00	€ 2.880,00
ARK300X120CC	3000X1200			€ 2.517,00	€ 2.927,00	€ 2.927,00	€ 2.927,00	€ 2.927,00	€ 3.084,00
ARK360X120CC	3600X1200			€ 2.911,00	€ 3.304,00	€ 3.304,00	€ 3.304,00	€ 3.304,00	€ 3.461,00
ARK240X120CCO	2400X1200	Powder coated Verniciato	CCO	€ 2.313,00	€ 2.880,00	€ 2.880,00	€ 2.880,00	€ 2.880,00	€ 3.037,00
ARK300X120CCO	3000X1200			€ 3.022,00	€ 3.430,00	€ 3.430,00	€ 3.430,00	€ 3.430,00	€ 3.587,00
ARK360X120CCO	3600X1200			€ 3.414,00	€ 3.808,00	€ 3.808,00	€ 3.808,00	€ 3.808,00	€ 3.965,00

(*) On request 60 mm width (CC60) cable management also available - same price
Disponibile a richiesta il tavolo con canalina larghezza 60 mm (CC60) allo stesso prezzo

TECHNICAL DETAILS / Dettagli tecnici

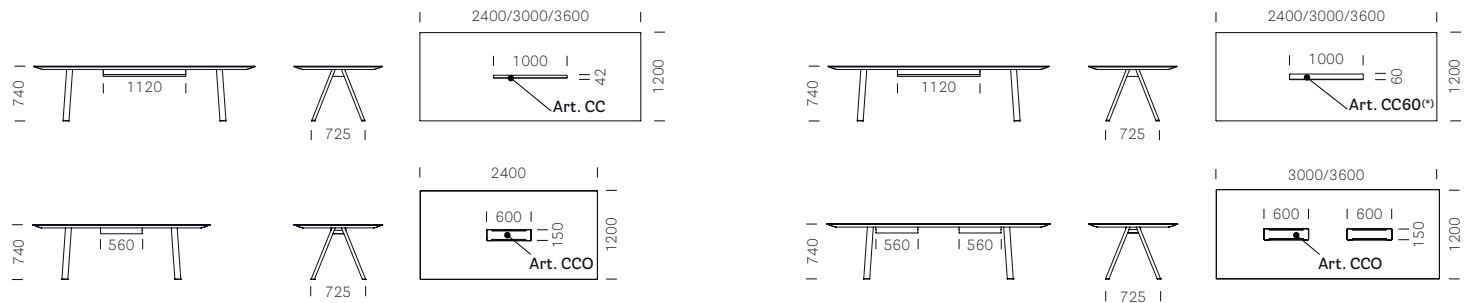

Prices refer to combinations provided for the pricelist. Other standard powder-coated finishes available on request, price surcharge € 158,00 (each table)
I prezzi si riferiscono alle combinazioni previste a listino. Disponibili a richiesta altri colori standard di verniciatura, supplemento € 158,00 (a tavolo)

Top, frame and frame top finishes Finiture ripiano, telaio e cornice

Table top Ripiano												
	CFC_BI	4519	527	4511	234	623	2810	4543	4529	1952	4512	4517
Frame Telaio												
	BI100	BE100	BE200	GA	MG	NERO						
Frame under the top Telaio sotto il ripiano												
	BI100	BI100	BI100	NERO	MG	NERO						

ARKI-TABLE - Fenix®

Fixed tables - with cable management / Tavoli fissi - con canalina



CCO

Hole with black powder coated cable management and cover in the same material of the top.
Spacco per passaggio cavi con canalina verniciata nero e coperchio di chiusura dello stesso materiale del ripiano.



CC / CC60

Item Articolo	Sizes Dimensioni	Finish Finitura	Cable management Canalina	Solid laminate top included Incluso ripiano in stratificato			
				FMP_NE (mm 12) plywood core anima in multistrati	FNP_NE (mm 6) black core anima nera	FNP_3452 (mm 6) black core anima nera	FNP_3455 (mm 6) white core anima bianca
ARK240X120CC	2400X1200	Powder coated Verniciato	CC (42 mm) *	€ 2.455,00	€ 2.723,00	€ 3.195,00	€ 3.917,00
ARK300X120CC	3000X1200			€ 2.880,00	€ 2.927,00	€ 3.399,00	€ 4.123,00
ARK360X120CC	3600X1200			-	€ 3.304,00	€ 3.461,00	€ 4.170,00
ARK240X120CCO	2400X1200	Powder coated Verniciato	CCO	€ 2.612,00	€ 2.880,00	-	-
ARK300X120CCO	3000X1200			€ 3.383,00	€ 3.430,00	-	-
ARK360X120CCO	3600X1200			-	€ 3.808,00	-	-

(*) On request 60 mm width (CC60) cable management also available - same price
Disponibile a richiesta il tavolo con canalina larghezza 60 mm (CC60) allo stesso prezzo

TECHNICAL DETAILS / Dettagli tecnici

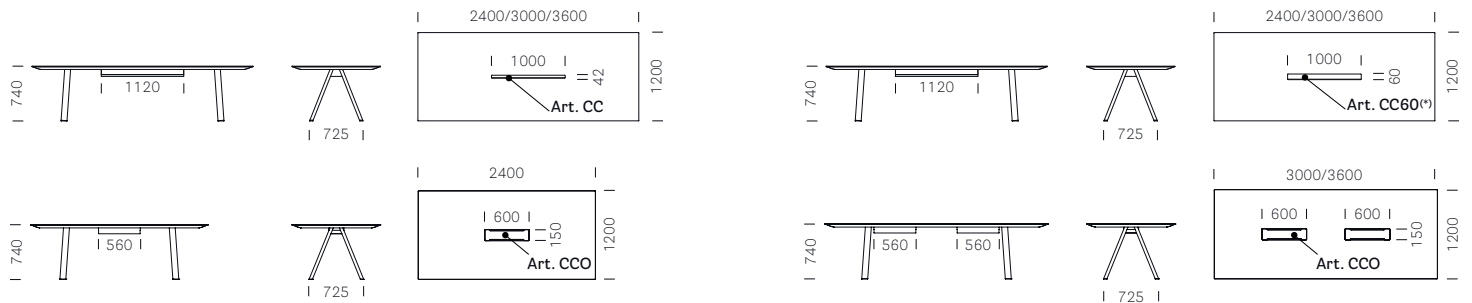

Prices refer to combinations provided for the pricelist. Other standard powder-coated finishes available on request, price surcharge € 158,00 (each table)
I prezzi si riferiscono alle combinazioni previste a listino. Disponibili a richiesta altri colori standard di verniciatura, supplemento € 158,00 (a tavolo)

Top, frame and frame top finishes Finiture ripiano, telaio e cornice

Table top
Ripiano

3455 3452 FMP/FNP

Anti-fingerprint finish
Finitura anti-impronta

Frame
Telaio

BI200 NERO

Frame under the top
Telaio sotto il ripiano

BI200 NERO

ARKI-TABLE Adj

Adjustable tables / Tavoli regolabili in altezza



Bluetooth control placed under the table top
Comando Bluetooth posizionato sotto il ripiano

Frame Telaio			Solid laminate top included Incluso ripiano in stratificato					
Item Articolo	Sizes Dimensioni	Finish Finitura	CFC_BI (mm 6) white core anima bianca	FMP_NE (mm 12) plywood core anima in multistrati	FNP_NE (mm 6) black core anima nera	COM 527, 234, 623 (mm 6) 527, 234, 623 core/anima	COM 4511, 4512, 4517, 4519 (mm 10) brown core anima marrone	COM 4543 (mm 10) brown core anima marrone
ARK200X100 REG BT	2000X1000	Powder coated Verniciato	€ 4.012,00	€ 4.090,00	€ 4.248,00	€ 4.248,00	€ 4.248,00	€ 4.405,00
ARK240X100 REG BT	2400X1000		€ 4.248,00	€ 4.327,00	€ 4.814,00	€ 4.814,00	€ 4.814,00	€ 4.972,00
ARK300X100 REG BT	3000X1000		€ 4.799,00	€ 4.972,00	€ 5.208,00	€ 5.208,00	€ 5.208,00	€ 5.366,00

US version available on request (to be stated on the purchase order): price surcharge € 111,00 per unit
Disponibile a richiesta la versione US: supplemento € 111,00 (da specificare in caso di ordine)

English plug version: surcharge € 33,00 (to be mentioned in case of order)
Versione con presa britannica: supplemento € 33,00 (da specificare in caso di ordine)

TECHNICAL DETAILS / Dettagli tecnici



Prices refer to combinations provided for the pricelist. Other standard powder-coated finishes available on request, price surcharge € 158,00 (each table)
I prezzi si riferiscono alle combinazioni previste a listino. Disponibili a richiesta altri colori standard di verniciatura, supplemento € 158,00 (a tavolo)

Top, frame and frame top finishes Finiture ripiano, telaio e cornice

Table top Ripiano														*Anti-fingerprint finish Finitura anti-impronta
	CFC_BI	4519	527	4511	234	623	2810	4543	4529	1952	4512	4517	FMP/ FNP*	
Frame Telaio														
	BI100	BE100	BE200	GA	MG	NERO	NERO	NERO	NERO	NERO	NERO	NERO	NERO	
Frame under the top Telaio sotto il ripiano														
	BI100	BI100	BI100	NERO	MG	NERO	MG	NERO	NERO	NERO	NERO	NERO	NERO	

ARKI-TABLE Wood

Fixed tables / Tavoli fissi



Frame Telaio			Solid laminate top included Incluso ripiano in stratificato				
Item Articolo	Sizes Dimensioni	Finish Finitura	CFC_BI (mm 6) white core anima bianca	FMP_NE (mm 12) plywood core anima in multistrati	FNP_NE (mm 6) black core anima nera	FNP_3452 (mm 6) black core anima nera	FNP_3455 (mm 6) white core anima bianca
ARKW200X100	2000X1000	RS	€ 1.967,00	€ 2.045,00	€ 2.203,00	€ 2.282,00	€ 2.597,00
ARKW240X100	2400X1000		€ 2.045,00	€ 2.125,00	€ 2.612,00	€ 3.084,00	€ 3.651,00
ARKW240X120	2400X1200		€ 2.156,00	€ 2.455,00	€ 2.723,00	€ 3.195,00	€ 3.760,00
ARKW300X100	3000X1000		€ 2.439,00	€ 2.612,00	€ 2.849,00	€ 3.321,00	€ 3.886,00
ARKW300X120	3000X1200		€ 2.517,00	€ 2.880,00	€ 2.927,00	€ 3.399,00	€ 3.965,00
ARKW360X120	3600X1200		€ 2.911,00	-	€ 3.304,00	€ 3.461,00	€ 4.012,00

TECHNICAL DETAILS / Dettagli tecnici



Top, frame and frame top finishes Finiture ripiano, telaio e cornice

Table top
Ripiano

CFC_BI 3455* 3452* FMP/FNP*

*Anti-fingerprint finish
Finitura anti-impronta

Frame
Telaio

RS RS

Frame under the top
Telaio sotto il ripiano

B100 NERO

ARKI-TABLE Wood

Fixed tables - with cable management / Tavoli fissi - con canalina



CCO

Hole with black powder coated cable management and cover in the same material of the top.
Spacco per passaggio cavi con canalina verniciata nero e coperchio di chiusura dello stesso materiale del ripiano.



CC / CC60

Frame Telaio				Solid laminate top included Incluso ripiano in stratificato				
Item Articolo	Sizes Dimensioni	Finish Finitura	Cable management Canalina	CFC_BI (mm 6) white core anima bianca	FMP_NE (mm 12) plywood core anima in multistrati	FNP_NE (mm 6) black core anima nera	FNP_3452 (mm 6) black core anima nera	FNP_3455 (mm 6) white core anima bianca
ARKW240X120CC	2400X1200	RS	CC (42 mm) *	€ 2.470,00	€ 2.769,00	€ 3.037,00	€ 3.509,00	€ 4.075,00
ARKW300X120CC	3000X1200			€ 2.832,00	€ 3.195,00	€ 3.241,00	€ 3.713,00	€ 4.280,00
ARKW360X120CC	3600X1200			€ 3.226,00	-	€ 3.618,00	€ 3.776,00	€ 4.327,00
ARKW240X120CCO	2400X1200	RS	CCO	€ 2.628,00	€ 2.927,00	€ 3.195,00	-	-
ARKW300X120CCO	3000X1200			€ 3.336,00	€ 3.698,00	€ 3.744,00	-	-
ARKW360X120CCO	3600X1200			€ 3.729,00	-	€ 4.123,00	-	-

(*) On request 60 mm width (CC60) cable management also available - same price
Disponibile a richiesta il tavolo con canalina larghezza 60 mm (CC60) allo stesso prezzo

TECHNICAL DETAILS / Dettagli tecnici

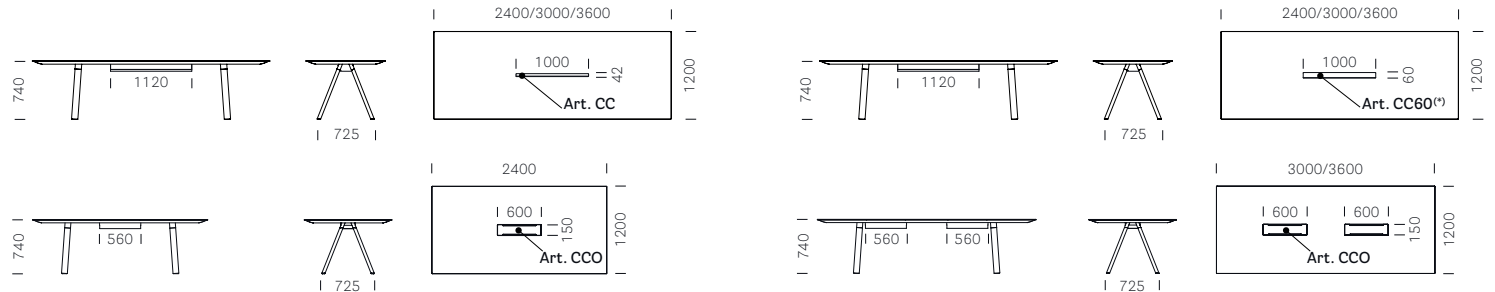

Top, frame and frame top finishes Finiture ripiano, telaio e cornice

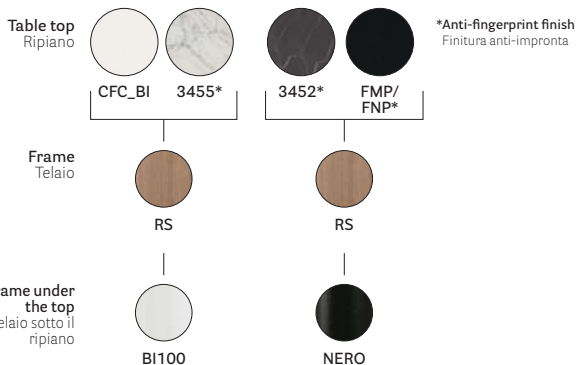

ARKI-TABLE Wood - Linoleum

Fixed tables / Tavoli fissi

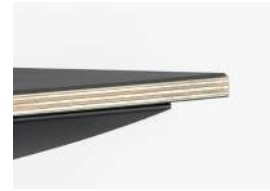

CC / CC60

Frame Telaio				Linoleum top included Incluso ripiano in linoleum
Item Articolo	Sizes Dimensioni	Finish Finitura	Cable management Canalina	LMP 4023, 4132 (mm 12) plywood core anima in multistrati
ARKW200X100	2000X1000	RS	Without cable management Senza canalina	€ 2.169,00
ARKW240X100	2400X1000			€ 2.400,00
ARKW240X120	2400X1200			€ 2.589,00
ARKW300X100	3000X1000			€ 2.946,00
ARKW300X120	3000X1200			€ 3.284,00
ARKW240X120CC	2400X1200	RS	CC (42 mm) *	€ 2.903,00
ARKW300X120CC	3000X1200			€ 3.599,00

(*) On request 60 mm width (CC60) cable management also available - same price
Disponibile a richiesta il tavolo con canalina larghezza 60 mm (CC60) allo stesso prezzo

TECHNICAL DETAILS / Dettagli tecnici

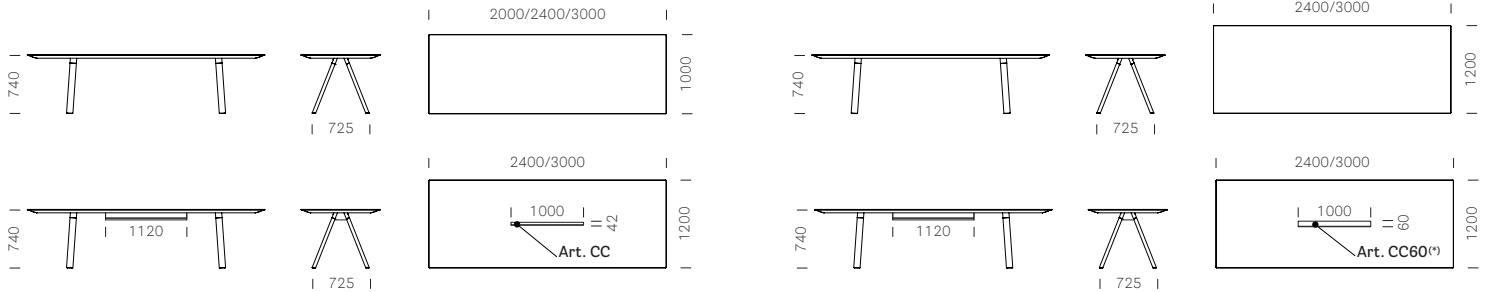

Top, frame and frame top finishes Finiture ripiano, telaio e cornice

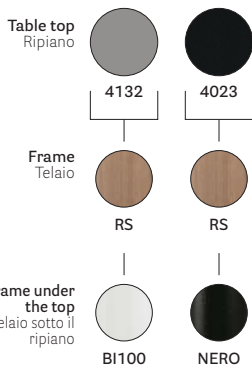

ARKI-TABLE

Fixed tables / Tavoli fissi



Frame Telaio			Solid laminate top included Incluso ripiano in stratificato						
Item Articolo	Sizes Dimensioni	Finish Finitura	CFC_BI (mm 12) white core anima bianca	FMP_NE (mm 12) plywood core anima in multistrati	FNP_NE (mm 10) black core anima nera	COM 2810 (mm 12) black core anima nera	COM 4511, 4512, 4517, 4519 (mm 10) brown core anima marrone	COM 4529 (mm 10) black core anima nera	COM 4543 (mm 10) brown core anima marrone
ARK/2_139X139	1384X1384	Powder coated Verniciato	€ 1.824,00	€ 1.824,00	€ 1.824,00	€ 1.593,00	€ 1.715,00	€ 1.715,00	€ 1.872,00
ARK/2_149X149	1490X1490		€ 1.989,00	€ 1.989,00	€ 1.989,00	€ 1.638,00	€ 1.794,00	€ 1.794,00	€ 1.952,00
ARK/2_159X159	1590X1590		€ 2.117,00	-	€ 2.117,00	€ 1.711,00	€ 1.880,00	€ 1.880,00	€ 2.038,00
ARK/2_D139	Ø 1384		€ 1.824,00	€ 1.824,00	€ 1.824,00	€ 1.593,00	€ 1.715,00	€ 1.715,00	€ 1.872,00
ARK/2_D149	Ø 1490		€ 1.989,00	€ 1.989,00	€ 1.989,00	€ 1.638,00	€ 1.794,00	€ 1.794,00	€ 1.952,00
ARK/2_D159	Ø 1590		€ 2.117,00	-	€ 2.117,00	€ 1.711,00	€ 1.880,00	€ 1.880,00	€ 2.038,00
ARKW/2_139X139	1384X1384	RS	€ 2.139,00	€ 2.139,00	€ 2.139,00	-	-	-	-
ARKW/2_149X149	1490X1490		€ 2.304,00	€ 2.304,00	€ 2.304,00	-	-	-	-
ARKW/2_159X159	1590X1590		€ 2.431,00	-	€ 2.431,00	-	-	-	-
ARKW/2_D139	Ø 1384		€ 2.139,00	€ 2.139,00	€ 2.139,00	-	-	-	-
ARKW/2_D149	Ø 1490		€ 2.304,00	€ 2.304,00	€ 2.304,00	-	-	-	-
ARKW/2_D159	Ø 1590		€ 2.431,00	-	€ 2.431,00	-	-	-	-

TECHNICAL DETAILS / Dettagli tecnici
Item ARK/2 - ARKW/2

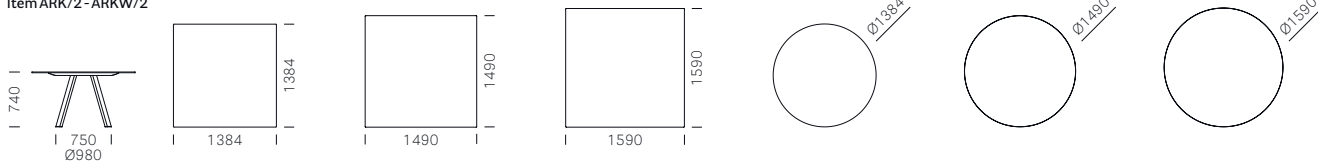

Prices refer to combinations provided for the pricelist. Other standard powder-coated finishes available on request, price surcharge € 158,00 (each table)
I prezzi si riferiscono alle combinazioni previste a listino. Disponibili a richiesta altri colori standard di verniciatura, supplemento € 158,00 (a tavolo)

Top, frame and frame top finishes
Finiture ripiano, telaio e cornice

Table top Ripiano												*Anti-fingerprint finish Finitura anti-impronta
	CFC_BI	4519	4511	2810	4543	4529	4512	4517	FMP/ FNP*	CFC_BI	FMP/ FNP*	
Frame Telaio												
	BI100	BE100	GA	MG	NERO	RS	RS			BI100	RS	
Frame under the top Telaio sotto il ripiano												
	BI100	BI100	NERO	MG	NERO	BI100	NERO			BI100	NERO	

ARKI-TABLE - Outdoor



Fixed tables / Tavoli fissi



Frame Telaio			Solid laminate top included Incluso ripiano in stratificato						
Item Articolo	Sizes Dimensioni	Finish Finitura	CFC_BI (mm 12) white core anima bianca	COM 4519 (mm 10) brown core anima marrone	COM 4529 (mm 10) black core anima nera	COM 2810 (mm 12) black core anima nera	CFP 3445 (mm 10) matching core anima in tinta	CFP 3447 (mm 10) matching core anima in tinta	COM 3471 (mm 10) beige core anima beige
ARK/2_139X139	1384X1384	Powder coated Verniciato	€ 1.982,00	€ 1.872,00	€ 1.872,00	€ 1.750,00	€ 2.139,00	€ 1.982,00	€ 1.982,00
ARK/2_149X149	1490X1490		€ 2.147,00	€ 1.952,00	€ 1.952,00	€ 1.796,00	€ 2.304,00	€ 2.147,00	€ 2.147,00
ARK/2_159X159	1590X1590		€ 2.274,00	€ 2.038,00	€ 2.038,00	€ 1.869,00	€ 2.431,00	€ 2.274,00	€ 2.274,00
ARK/2_D139	Ø 1384		€ 1.982,00	€ 1.872,00	€ 1.872,00	€ 1.750,00	€ 2.139,00	€ 1.982,00	€ 1.982,00
ARK/2_D149	Ø 1490		€ 2.147,00	€ 1.952,00	€ 1.952,00	€ 1.796,00	€ 2.304,00	€ 2.147,00	€ 2.147,00
ARK/2_D159	Ø 1590		€ 2.274,00	€ 2.038,00	€ 2.038,00	€ 1.869,00	€ 2.431,00	€ 2.274,00	€ 2.274,00

TECHNICAL DETAILS / Dettagli tecnici

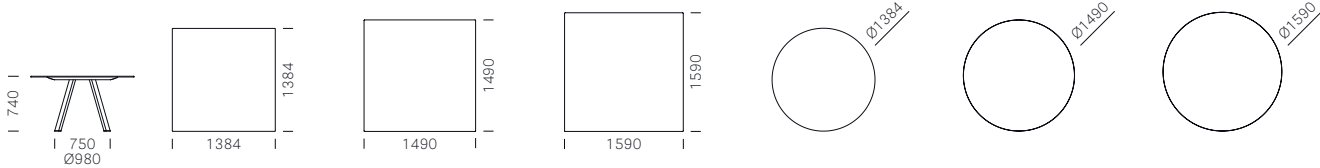

Prices refer to combinations provided for the pricelist. Other standard powder-coated finishes available on request, price surcharge € 158,00 (each table)
I prezzi si riferiscono alle combinazioni previste a listino. Disponibili a richiesta altri colori standard di verniciatura, supplemento € 158,00 (a tavolo)

Top, frame and frame top finishes Finiture ripiano, telaio e cornice

Table top Ripiano								
	CFC_BI	4519	3471	2810	3445	3447	4529	
Frame Telaio								
	BI100E	BE100E	GAE	BI200E	MGE	BE100E	BE200E	NPE
Frame under the top Telaio sotto il ripiano								
	BI100E	BI100E	NPE	BI200E	MGE	BI100E	NPE	

ARKI-TABLE

Fixed tables - with cable management / Tavoli fissi - con canalina



CCO

Hole with black powder coated cable management and cover in the same material of the top.
Spacco per passaggio cavi con canalina verniciata nero e coperchio di chiusura dello stesso materiale del ripiano.

Frame Telaio			Cable management Canalina	Solid laminate top included Incluso ripiano in stratificato						
Item Articolo	Sizes Dimensioni	Finish Finitura		CFC_BI (mm 12) white core anima bianca	FMP_NE (mm 12) plywood core anima in multistrati	FNP_NE (mm 10) black core anima nera	COM 2810 (mm 12) black core anima nera	COM 4511, 4512, 4517, 4519 (mm 10) brown core anima marrone	COM 4529 (mm 10) black core anima nera	COM 4543 (mm 10) brown core anima marrone
ARK/2_139X139CCO	1384X1384	Powder coated Verniciato	CCO	€ 2.019,00	€ 2.019,00	€ 2.019,00	€ 1.788,00	€ 1.910,00	€ 1.910,00	€ 2.067,00
ARK/2_149X149CCO	1490X1490			€ 2.184,00	€ 2.184,00	€ 2.184,00	€ 1.833,00	€ 1.989,00	€ 1.989,00	€ 2.147,00
ARK/2_159X159CCO	1590X1590			€ 2.312,00	-	€ 2.312,00	€ 1.906,00	€ 2.075,00	€ 2.075,00	€ 2.233,00
ARK/2_D139CCO	Ø 1384			€ 2.019,00	€ 2.019,00	€ 2.019,00	€ 1.788,00	€ 1.910,00	€ 1.910,00	€ 2.067,00
ARK/2_D149CCO	Ø 1490			€ 2.184,00	€ 2.184,00	€ 2.184,00	€ 1.833,00	€ 1.989,00	€ 1.989,00	€ 2.147,00
ARK/2_D159CCO	Ø 1590			€ 2.312,00	-	€ 2.312,00	€ 1.906,00	€ 2.075,00	€ 2.075,00	€ 2.233,00
ARKW/2_139X139CCO	1384X1384	RS	CCO	€ 2.334,00	€ 2.334,00	€ 2.334,00	-	-	-	-
ARKW/2_149X149CCO	1490X1490			€ 2.499,00	€ 2.499,00	€ 2.499,00	-	-	-	-
ARKW/2_159X159CCO	1590X1590			€ 2.626,00	-	€ 2.626,00	-	-	-	-
ARKW/2_D139CCO	Ø 1384			€ 2.334,00	€ 2.334,00	€ 2.334,00	-	-	-	-
ARKW/2_D149CCO	Ø 1490			€ 2.499,00	€ 2.499,00	€ 2.499,00	-	-	-	-
ARKW/2_D159CCO	Ø 1590			€ 2.626,00	-	€ 2.626,00	-	-	-	-

TECHNICAL DETAILS / Dettagli tecnici

Item ARK/2 - ARKW/2

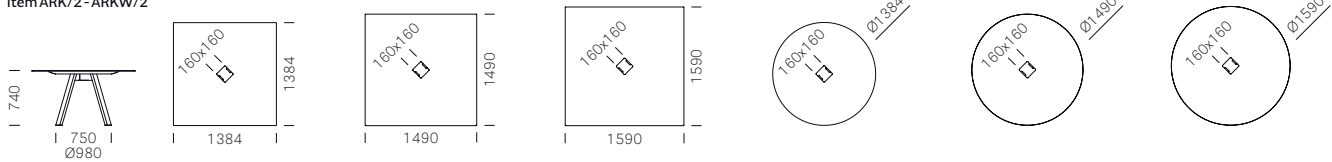

Prices refer to combinations provided for the pricelist. Other standard powder-coated finishes available on request, price surcharge € 158,00 (each table)
I prezzi si riferiscono alle combinazioni previste a listino. Disponibili a richiesta altri colori standard di verniciatura, supplemento € 158,00 (a tavolo)

Top, frame and frame top finishes

Finiture ripiano, telaio e cornice

Table top Ripiano

Frame Telaio

Frame under the top Telaio sotto il ripiano

*Anti-fingerprint finish Finitura anti-impronta

ARKI-TABLE - Compact

Fixed tables / Tavoli fissi



Item Articolo	Frame Telaio		Cable management Canalina	Solid laminate top included Incluso ripiano in stratificato					
	Sizes Dimensioni	Finish Finitura		CFC_BI (mm 6) white core anima bianca	COM 527, 234, 623 (mm 6) 527, 234, 623 core/anima	COM 2810 (mm 12) black core anima nera	COM 4511, 4512, 4517, 4519 (mm 10) brown core anima marrone	COM 4529, 1952 (mm 10) black core anima nera	COM 4543 (mm 10) brown core anima marrone
ARK107_200X79	2000X790	Powder coated Verniciato		€ 1.810,00	€ 2.045,00	€ 2.045,00	€ 2.045,00	€ 2.045,00	€ 2.203,00
ARK107_200X79CC			CC (42 mm) *	€ 2.045,00	€ 2.282,00	€ 2.282,00	€ 2.282,00	€ 2.282,00	€ 2.439,00

(*) On request 60 mm width (CC60) cable management also available - same price
Disponibile a richiesta il tavolo con canalina larghezza 60 mm (CC60) allo stesso prezzo

TECHNICAL DETAILS / Dettagli tecnici



Prices refer to combinations provided for the pricelist. Other standard powder-coated finishes available on request, price surcharge € 158,00 (each table)
I prezzi si riferiscono alle combinazioni previste a listino. Disponibili a richiesta altri colori standard di verniciatura, supplemento € 158,00 (a tavolo)

Top, frame and frame top finishes Finiture ripiano, telaio e cornice

Table top Ripiano												
	CFC_BI	4519	527	4511	234	623	2810	4543	4529	1952	4512	4517
Frame Telaio												
	BI100	BE100	BE200	GA	MG	NERO						
Frame under the top Telaio sotto il ripiano												
	BI100	BI100	BI100	NERO	MG	NERO						

ARKI-TABLE - Outdoor



Fixed tables / Tavoli fissi

VAT NOT INCLUDED / Iva esclusa

Tables / Tavoli



Frame Telaio			Solid laminate top included Incluso ripiano in stratificato				
Item Articolo	Sizes Dimensioni	Finish Finitura	CFC_BI (mm 6) white core anima bianca	COM_527 (mm 6) 527 core/anima	COM 2810 (mm 12) black core anima nera	CFP 3445 (mm 10) matching core anima in tinta	CFP 3447 (mm 10) matching core anima in tinta
ARK107_200X79	2000X790	Powder coated Verniciato	€ 1.967,00	€ 2.203,00	€ 2.203,00	€ 2.439,00	€ 2.282,00

TECHNICAL DETAILS / Dettagli tecnici



Prices refer to combinations provided for the pricelist. Other standard powder-coated finishes available on request, price surcharge € 158,00 (each table)
I prezzi si riferiscono alle combinazioni previste a listino. Disponibili a richiesta altri colori standard di verniciatura, supplemento € 158,00 (a tavolo)

Top, frame and frame top finishes Finiture ripiano, telaio e cornice

Table top Ripiano							
	CFC_BI	527	2810	3445	3447		
Frame Telaio							
	BI100E	BE100E	GAE	BI200E	MGE	BE100E	BE200E
Frame under the top Telaio sotto il ripiano							
	BI100E	BI100E	NPE	BI200E	MGE	BI100E	

ARKI-TABLE - Fenix®

Fixed tables / Tavoli fissi



Frame Telaio				Solid laminate top included Incluso ripiano in stratificato			
Item Articolo	Sizes Dimensioni	Finish Finitura	Cable management Canalina	FMP_NE (mm 12) plywood core anima in multistrati	FNP_NE (mm 6) black core anima nera	FNP_3452 (mm 6) black core anima nera	FNP_3455 (mm 6) white core anima bianca
ARK107_200X79	2000X790	Powder coated Verniciato		€ 1.888,00	€ 2.045,00	€ 2.125,00	€ 2.597,00
ARK107_200X79CC			CC (42 mm) *	€ 2.125,00	€ 2.282,00	€ 2.360,00	€ 2.832,00

(*) On request 60 mm width (CC60) cable management also available - same price
Disponibile a richiesta il tavolo con canalina larghezza 60 mm (CC60) allo stesso prezzo

TECHNICAL DETAILS / Dettagli tecnici



Prices refer to combinations provided for the pricelist. Other standard powder-coated finishes available on request, price surcharge € 158,00 (each table)
I prezzi si riferiscono alle combinazioni previste a listino. Disponibili a richiesta altri colori standard di verniciatura, supplemento € 158,00 (a tavolo)

Top, frame and frame top finishes Finiture ripiano, telaio e cornice

Table top
Ripiano

- 3455
- 3452
- FMP/
FNP

Anti-fingerprint finish
Finitura anti-impronta

Frame
Telaio

- BI200
- NERO

Frame under the top
Telaio sotto il ripiano

- BI200
- NERO

ARKI-TABLE Wood

Fixed tables / Tavoli fissi



Frame Telaio			Cable management Canalina	Solid laminate top included Incluso ripiano in stratificato				
Item Articolo	Sizes Dimensioni	Finish Finitura		CFC_BI (mm 6) white core anima bianca	FMP_NE (mm 12) plywood core anima in multistrati	FNP_NE (mm 6) black core anima nera	FNP_3452 (mm 6) black core anima nera	FNP_3455 (mm 6) white core anima bianca
ARKW107_200X79	2000X790	RS		€ 2.187,00	€ 2.266,00	€ 2.424,00	€ 2.502,00	€ 2.816,00
ARKW107_200X79CC			CC (42 mm) *	€ 2.424,00	€ 2.502,00	€ 2.659,00	€ 2.738,00	€ 3.053,00

(*) On request 60 mm width (CC60) cable management also available - same price
Disponibile a richiesta il tavolo con canalina larghezza 60 mm (CC60) allo stesso prezzo

TECHNICAL DETAILS / Dettagli tecnici



Top, frame and frame top finishes Finiture ripiano, telaio e cornice

**Table top
Ripiano**

CFC_BI 3455* 3452* FMP/FNP*

*Anti-fingerprint finish
Finitura anti-impronta

**Frame
Telaio**

RS RS

**Frame under the top
Telaio sotto il ripiano**

BI100 NERO

ARKI-TABLE - ARK5/2

Fixed tables - with solid laminate top / Tavoli fissi - con ripiano in stratificato



Frame Telaio		Solid laminate top included Incluso ripiano in stratificato					
Item Articolo	Finish Finitura	Sizes Dimensioni	CFP_BI (mm 12) white core anima bianca	FMP_NE (mm 12) plywood core anima in multistrati	FNP_NE (mm 10) black core anima nera	COP_2810 (mm 12) black core anima nera	COP_4543 (mm 10) brown core anima marrone
ARK5/2_79X79	Powder coated Verniciato	790X790	€ 662,00	€ 597,00	€ 592,00	€ 519,00	€ 497,00
ARK5/2_89X89		890X890	€ 723,00	€ 661,00	€ 665,00	€ 578,00	€ 552,00
ARK5/2_99X99		990X990	€ 800,00	€ 778,00	€ 744,00	€ 630,00	€ 584,00
ARK5/2_109X109		1090X1090	€ 917,00	€ 982,00	€ 834,00	€ 696,00	€ 644,00
ARK5/2_119X119		1190X1190	€ 1.105,00	€ 1.053,00	€ 992,00	€ 810,00	€ 741,00
ARK5/2_D_99		Ø990	€ 800,00	€ 778,00	€ 744,00	€ 630,00	€ 584,00
ARK5/2_D109		Ø1090	€ 917,00	€ 982,00	€ 834,00	€ 696,00	€ 644,00
ARK5/2_D119		Ø1190	€ 1.105,00	€ 1.053,00	€ 992,00	€ 810,00	€ 741,00
ARK5/2_D129		Ø1290	€ 1.235,00	€ 1.144,00	€ 1.105,00	€ 865,00	€ 826,00

TECHNICAL DETAILS / Dettagli tecnici

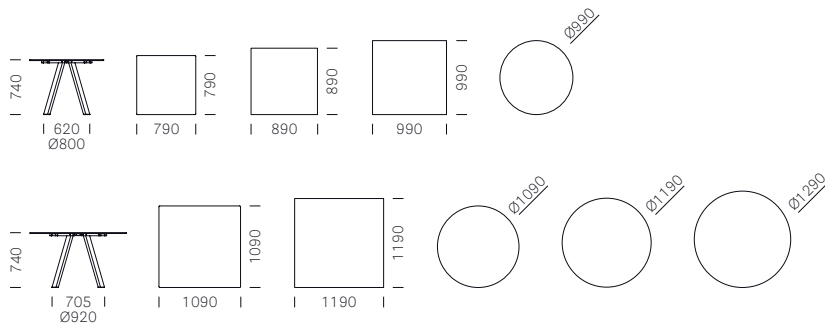

On request other standard colours powder coated available - same price
Disponibile a richiesta il telaio verniciato in altri colori standard, allo stesso prezzo

Top and frame finishes Finiture ripiano e telaio

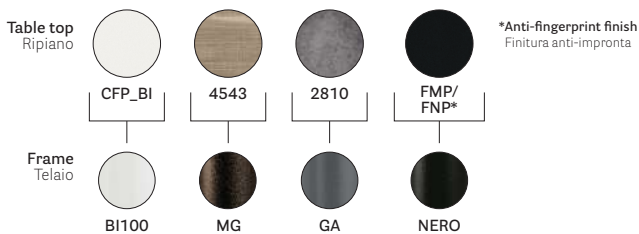

ARKI-TABLE - ARK5/2



Fixed tables - with solid laminate top / Tavoli fissi - con ripiano in stratificato

VAT NOT INCLUDED / Iva esclusa

Tables / Tavoli



Frame Telaio		Solid laminate top included Incluso ripiano in stratificato			
Item Articolo	Finish Finitura	Sizes Dimensioni	CFP_BI (mm 12) white core anima bianca	COP_2810 (mm 12) black core anima nera	CFP 3445, 3447 (mm 10) matching core anima in tinta
ARK5/2_79X79	Powder coated Verniciato	790X790	€ 819,00	€ 676,00	€ 819,00
ARK5/2_89X89		890X890	€ 881,00	€ 735,00	€ 881,00
ARK5/2_99X99		990X990	€ 957,00	€ 787,00	€ 957,00
ARK5/2_109X109		1090X1090	€ 1.074,00	€ 853,00	€ 1.074,00
ARK5/2_119X119		1190X1190	€ 1.263,00	€ 968,00	€ 1.263,00
ARK5/2_D_99		Ø990	€ 957,00	€ 787,00	€ 957,00
ARK5/2_D109		Ø1090	€ 1.074,00	€ 853,00	€ 1.074,00
ARK5/2_D119		Ø1190	€ 1.263,00	€ 968,00	€ 1.263,00
ARK5/2_D129		Ø1290	€ 1.393,00	€ 1.022,00	€ 1.393,00

TECHNICAL DETAILS / Dettagli tecnici

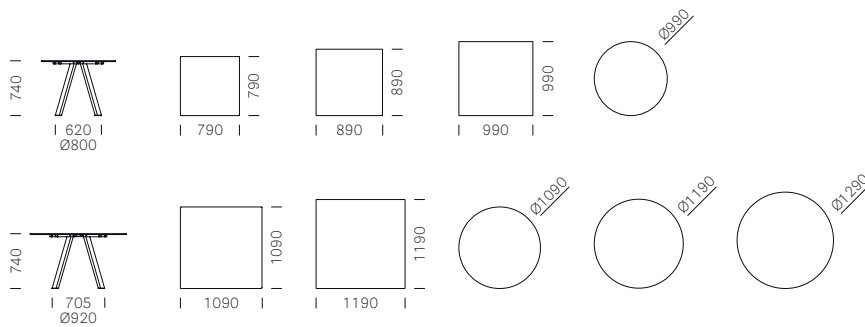

On request other standard colours powder coated available - same price
Disponibile a richiesta il telaio verniciato in altri colori standard, allo stesso prezzo

Top and frame finishes Finiture ripiano e telaio

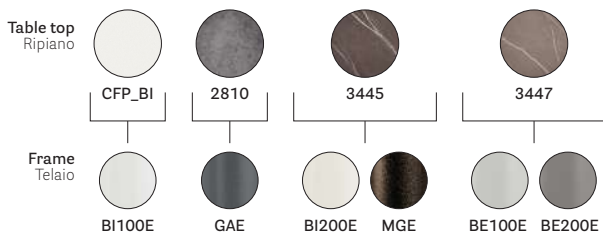

ARKI-TABLE - ARK5/2

Fixed tables - with laminate top / Tavoli fissi - con ripiani in laminato



Frame Telaio		Laminated top included Incluso ripiano in laminato		
Item Articolo	Finish Finitura	Sizes Dimensioni	BA/20 406_0020, 4511, 4512, 4517, 4519, 4529, 4543 (mm 20)	BA/20 FN 0720 (mm 20)
ARK5/2_79X79	Powder coated Verniciato	790X790	€ 389,00	€ 420,00
ARK5/2_89X89		890X890	€ 416,00	€ 462,00
ARK5/2_99X99		990X990	€ 449,00	€ 491,00
ARK5/2_109X109		1090X1090	€ 520,00	€ 645,00
ARK5/2_119X119		1190X1190	€ 544,00	€ 682,00
ARK5/2_D_99		Ø990	€ 488,00	€ 567,00
ARK5/2_D109		Ø1090	€ 559,00	€ 695,00
ARK5/2_D119		Ø1190	€ 587,00	€ 736,00
ARK5/2_D129		Ø1290	€ 641,00	€ 809,00

TECHNICAL DETAILS / Dettagli tecnici

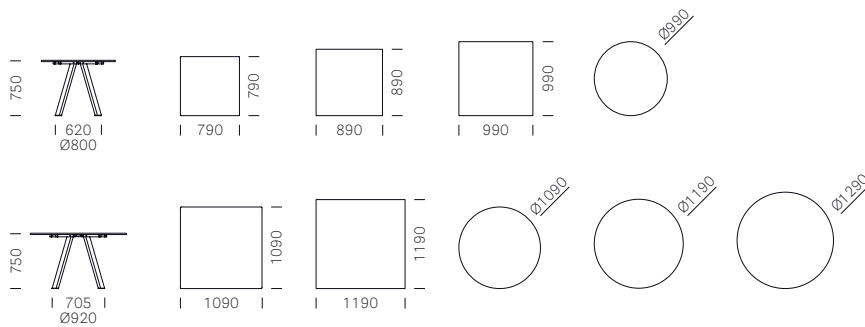

On request other standard colours powder coated available - same price
Disponibile a richiesta il telaio verniciato in altri colori standard, allo stesso prezzo

Top and frame finishes Finiture ripiano e telaio

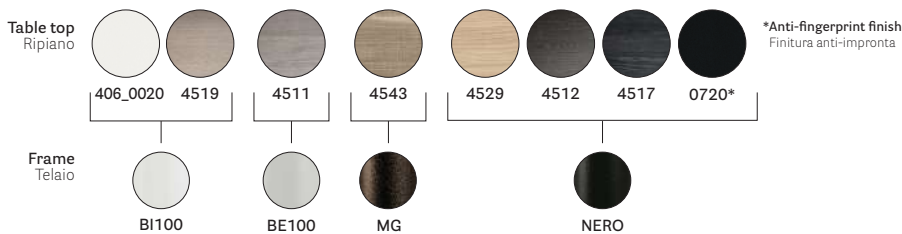

ARKI-TABLE - ARKW5/2 Wood

Fixed tables / Tavoli fissi



Frame Telaio		Solid laminate top included Incluso ripiano in stratificato			
Item Articolo	Finish Finitura	Sizes Dimensioni	CFP_BI (mm 12) white core anima bianca	FMP_NE (mm 12) plywood core anima in multistrati	FNP_NE (mm 10) black core anima nera
ARKW5/2_79X79	RS	790X790	€ 977,00	€ 912,00	€ 907,00
ARKW5/2_89X89		890X890	€ 1.038,00	€ 975,00	€ 979,00
ARKW5/2_99X99		990X990	€ 1.115,00	€ 1.092,00	€ 1.059,00
ARKW5/2_109X109		1090X1090	€ 1.232,00	€ 1.297,00	€ 1.148,00
ARKW5/2_119X119		1190X1190	€ 1.420,00	€ 1.368,00	€ 1.307,00
ARKW5/2_D_99		Ø990	€ 1.115,00	€ 1.092,00	€ 1.059,00
ARKW5/2_D109		Ø1090	€ 1.232,00	€ 1.297,00	€ 1.148,00
ARKW5/2_D119		Ø1190	€ 1.420,00	€ 1.368,00	€ 1.307,00
ARKW5/2_D129		Ø1290	€ 1.550,00	€ 1.459,00	€ 1.420,00

TECHNICAL DETAILS / Dettagli tecnici

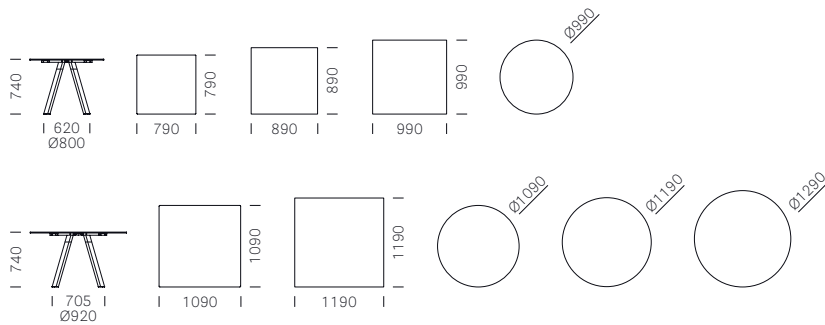

Top and frame finishes Finiture ripiano e telaio

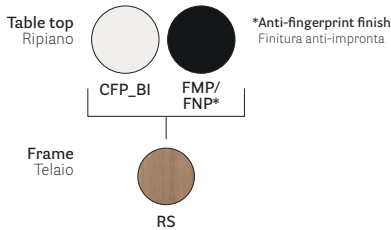

ARKI-DESK - Compact

Fixed tables / Tavoli fissi



Frame Telaio			Solid laminate top included Incluso ripiano in stratificato					
Item Articolo	Sizes Dimensioni	Finish Finitura	CFC_BI (mm 12) white core anima bianca	FNP_NE (mm 10) black core anima nera	COM 527, 623 (mm 10) black core anima nera	COM 4511, 4512, 4517, 4519, 4543 (mm 10) brown core anima marrone	COM 4529, 1952 (mm 10) black core anima nera	COM 2810 (mm 12) black core anima nera
ARK7_139X69	1390X690	POWDER COATED / Verniciato	€ 801,00	€ 760,00	€ 641,00	€ 641,00	€ 641,00	€ 641,00
ARK7_159X69	1590X690		€ 869,00	€ 816,00	€ 684,00	€ 684,00	€ 684,00	€ 684,00
ARK7_159X79	1590X790		€ 934,00	€ 873,00	€ 722,00	€ 722,00	€ 722,00	€ 722,00
ARK7_179X79	1790X790		€ 996,00	€ 939,00	€ 760,00	€ 760,00	€ 760,00	€ 760,00
ARK7_199X79	1990X790		€ 1.070,00	€ 996,00	€ 806,00	€ 806,00	€ 806,00	€ 806,00

TECHNICAL DETAILS / Dettagli tecnici

Item ARK7_139X69



Item ARK7_159X69



Item ARK7_159X79



Item ARK7_179X79



Item ARK7_199X79



On request other standard colours powder coated available - same price
Disponibile a richiesta il telaio verniciato in altri colori standard, allo stesso prezzo

Top finishes

Finiture ripiano

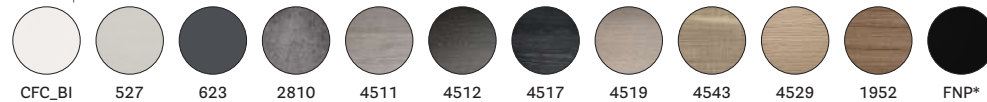

*Anti-fingerprint finish
Finitura anti-impronta

Frame finishes

Finiture telaio



ARKI-DESK - Laminate

Fixed tables / Tavoli fissi



Frame Telaio		Laminate top included Incluso ripiano in laminato		
Item Articolo	Sizes Dimensioni	Finish Finitura	BA/20 406_0020, 4511, 4512, 4517, 4519, 4529, 4543 (mm 20)	BA/20FN 0718, 0720 (mm 20)
ARK7_139X69	1390X690	POWDER COATED / Verniciato	€ 497,00	€ 591,00
ARK7_159X69	1590X690		€ 528,00	€ 630,00
ARK7_159X79	1590X790		€ 528,00	€ 630,00
ARK7_179X79	1790X790		€ 552,00	€ 670,00
ARK7_199X79	1990X790		€ 630,00	€ 796,00

TECHNICAL DETAILS / Dettagli tecnici

Item ARK7_139X69



Item ARK7_159X69



Item ARK7_159X79



Item ARK7_179X79



Item ARK7_199X79



On request other standard colours powder coated available - same price
Disponibile a richiesta il telaio verniciato in altri colori standard, allo stesso prezzo

Top finishes

Finiture ripiano



*Anti-fingerprint finish
Finitura anti-impronta

Frame finishes

Finiture telaio



ARKI-DESK Wood

Fixed tables / Tavoli fissi



Item Articolo	Frame Telaio		Solid laminate top included Incluso ripiano in stratificato		Laminate top included Incluso ripiano in laminato	
	Sizes Dimensioni	Finish Finitura	CFC_BI (mm 12) white core anima bianca	FNP_NE (mm 10) black core anima nera	BA/20 406_0020 (mm 20)	BA/20FN 0718, 0720 (mm 20)
ARKW7_139X69	1390X690	RS	€ 1.116,00	€ 1.074,00	€ 812,00	€ 905,00
ARKW7_159X69	1590X690		€ 1.183,00	€ 1.130,00	€ 843,00	€ 944,00
ARKW7_159X79	1590X790		€ 1.248,00	€ 1.187,00	€ 843,00	€ 944,00
ARKW7_179X79	1790X790		€ 1.311,00	€ 1.254,00	€ 866,00	€ 985,00
ARKW7_199X79	1990X790		€ 1.385,00	€ 1.311,00	€ 944,00	€ 1.111,00

TECHNICAL DETAILS / Dettagli tecnici

Item ARKW7_139X69*



Item ARKW7_159X69*



Item ARKW7_159X79*



Item ARKW7_179X79*



Item ARKW7_199X79*



* Table height increases of 1 cm for laminate top versions
L'altezza del tavolo aumenta di 1 cm per le versioni con ripiano in laminato

Solid laminate top finishes Finiture ripiano in stratificato



Laminate top finishes Finiture ripiano in laminato

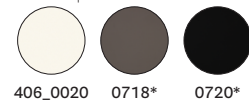

*Anti-fingerprint finish
Finitura anti-impronta

Frame finishes Finiture telaio



ARKI-TABLE Adj Desk - Compact

Adjustable tables / Tavoli regolabili in altezza



Bluetooth control placed under the table top
Comando Bluetooth posizionato sotto il ripiano

Frame Telaio			Solid laminate top included Incluso ripiano in stratificato								Fittings Accessori
Item Articolo	Sizes Dimensioni	Finish Finitura	CFC_BI (mm 6) white core anima bianca	FMP_NE (mm 12) plywood core anima in multistrati	FNP_NE (mm 6) black core anima nera	COM 527, 234, 623 (mm 6) 527, 234, 623 core/anima	COM 4511, 4512, 4517, 4519 (mm 10) brown core anima marrone	COM 4529, 1952 (mm 10) black core anima nera	COM 2810 (mm 12) black core anima nera	COM 4543 (mm 10) brown core anima marrone	
ARKS180X79 REG BT	1800X790	Powder coated Verniciato	€ 3.257,00	€ 3.430,00	€ 3.461,00	€ 3.304,00	€ 3.304,00	€ 3.304,00	€ 3.304,00	€ 3.461,00	-
ARKS.20 Panel only Solo pannello	1790X670h	C83+C89; C100+C101 C110+C122 C210+C217									€ 544,00
		G									€ 771,00
		Excluding / Escluso H60+H61 H120+H127	G180+G185, G220+G225, G230+G239								

US version available on request (to be stated on the purchase order); price surcharge € 111,00 per unit
Disponibile a richiesta la versione US; supplemento € 111,00 (da specificare in caso di ordine)

TECHNICAL DETAILS / Dettagli tecnici

Item ARKS180X79 REG BT



Fittings / Accessori

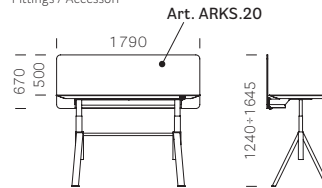

For fabrics see page 284
Per i tessuti si veda p. 284

Prices refer to combinations provided for the pricelist. Other standard powder-coated finishes available on request, price surcharge € 158,00 (each table)
I prezzi si riferiscono alle combinazioni previste a listino. Disponibili a richiesta altri colori standard di verniciatura, supplemento € 158,00 (a tavolo)

Top, frame and frame top finishes Finiture ripiano, telaio e cornice

Table top Ripiano														*Anti-fingerprint finish Finitura anti-impronta
Frame Telaio														
Frame under the top Telaio sotto il ripiano														

ARKI-TABLE Adj Desk - Laminate

Adjustable tables / Tavoli regolabili in altezza



Bluetooth control placed under the table top
Comando Bluetooth posizionato sotto il ripiano

Frame Telaio		Laminate top included Incluso ripiano in laminato		Fittings Accessori
Item Articolo	Sizes Dimensioni	Finish Finitura	BA/20 406_0020 (mm 20)	
ARKS180X79 REG BT	1800X790	Powder coated Verniciato	€ 2.321,00	-
ARKS.20 Panel only Solo pannello	1790X670h	C83+C89; C100+C101 C110+C122 C210+C217		€ 544,00
		G Excluding / Escluso G180+G185, G220+G225, G230+G239		€ 771,00
		H60+H61 H120+H127		€ 575,00

US version available on request (to be stated on the purchase order): price surcharge € 111,00 per unit
Disponibile a richiesta la versione US: supplemento € 111,00 (da specificare in caso di ordine)

TECHNICAL DETAILS / Dettagli tecnici

Item ARKS180X79 REG BT



Fittings / Accessori

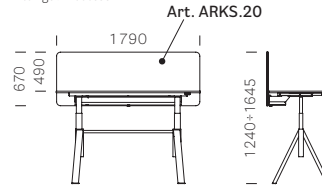

For fabrics see page 284
Per i tessuti si veda p. 284

Top finishes Finiture ripiano



406_0020

Frame finishes Finiture telaio



B1100

BABILA table

Fixed tables / Tavoli fissi

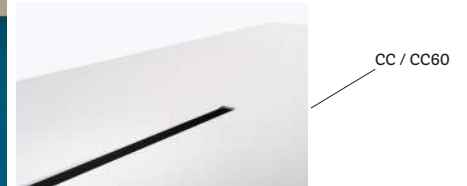

Frame Telaio			Solid laminate top included Incluso ripiano in stratificato					
Item Articolo	Sizes Dimensioni	Finish Finitura	Cable management Canalina	CFC_BI (mm 6)	FNP_NE (mm 6)	COM 527, 234, 623 (mm 6)	FNP_3452 (mm 6)	FNP_3455 (mm 6)
TBA_90X90	900X900	FR/AN/N1	Without cable management Senza canalina	€ 1.248,00	€ 1.248,00	€ 1.865,00	€ 1.458,00	€ 1.577,00
TBA D139	∅ 1390			€ 1.902,00	€ 1.978,00	-	-	-
TBA160X90	1590X900			€ 1.637,00	€ 1.637,00	€ 1.992,00	€ 1.969,00	€ 2.238,00
TBA200X90	2000X900			€ 1.833,00	€ 2.054,00	€ 2.248,00	€ 2.080,00	€ 2.470,00
TBA200X100	2000X1000			€ 1.848,00	€ 2.080,00	€ 2.262,00	€ 2.106,00	€ 2.496,00
TBA240X100	2400X1000			€ 1.908,00	€ 2.491,00	€ 2.338,00	€ 2.862,00	€ 3.403,00
TBA300X100	3000X1000			€ 2.366,00	€ 2.795,00	€ 3.202,00	€ 3.395,00	€ 3.936,00
TBA200X100CC	2000X1000			With cable management Con canalina	€ 2.152,00	€ 2.196,00	€ 2.565,00	€ 2.272,00
TBA240X100CC	2400X1000	Width/Larghezza: 42 mm (item CC)	€ 2.212,00	€ 2.715,00	€ 2.641,00	€ 3.165,00	€ 3.705,00	

(*) On request 60 mm width (CC60) cable management also available - same price
Disponibile a richiesta il tavolo con canalina larghezza 60 mm (CC60) allo stesso prezzo

TECHNICAL DETAILS / Dettagli tecnici

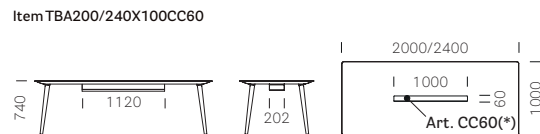
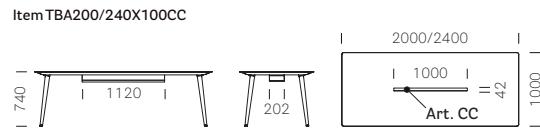
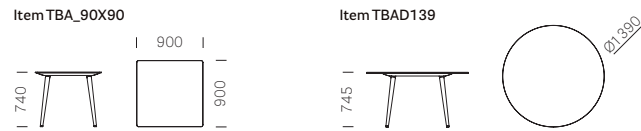

Solid laminate top Ripiani in stratificato



*Anti-fingerprint finish
Finitura anti-impronta

Ash frame Telaio in Frassino



BABILA table - Outdoor



Fixed tables / Tavoli fissi

VAT NOT INCLUDED / Iva esclusa

Tables / Tavoli



Frame Telaio			Solid laminate top included Incluso ripiano in stratificato					
Item Articolo	Sizes Dimensioni	Finish Finitura	CFC_BI (mm 6) white core anima bianca	COM 527 (mm 6) 527 core/anima COM 2810 (mm 12) black core anima nera	COM 4519 (mm 10) brown core anima marrone COM 4529, 1952 (mm 10) black core anima nera	CFP 3445 (mm 10) matching core anima in tinta	CFP 3447 (mm 10) matching core anima in tinta	COM 3471 (mm 10) beige core anima beige
TBA/2_90X90	900X900	Powder coated Verniciato	€ 1.248,00	€ 1.485,00	€ 1.485,00	€ 1.720,00	€ 1.563,00	€ 1.878,00
TBA/2_160X90	1590X900		€ 1.615,00	€ 1.850,00	€ 1.850,00	€ 2.087,00	€ 1.930,00	€ 2.244,00
TBA/2_200X90	2000X900		€ 1.810,00	€ 2.045,00	€ 2.045,00	€ 2.282,00	€ 2.125,00	€ 2.439,00
TBA/2_200X100	2000X1000		€ 1.810,00	€ 2.045,00	€ 2.045,00	€ 2.282,00	€ 2.125,00	€ 2.439,00
TBA/2_240X100	2400X1000		€ 1.888,00	€ 2.455,00	€ 2.455,00	€ 2.470,00	€ 2.313,00	€ 3.494,00
TBA/2_300X100	3000X1000		€ 2.282,00	€ 2.691,00	€ 2.691,00	€ 2.911,00	€ 2.754,00	€ 3.729,00

TECHNICAL DETAILS / Dettagli tecnici

Item TBA/2_90X90

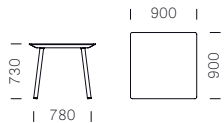

Item TBA/2_160/200X90



Item TBA/2_200/240/300X100



Prices refer to combinations provided for the pricelist. Other standard powder-coated finishes available on request, price surcharge € 158,00 (each table)
I prezzi si riferiscono alle combinazioni previste a listino. Disponibili a richiesta altri colori standard di verniciatura, supplemento € 158,00 (a tavolo)

Top, frame and frame top finishes Finiture ripiano, telaio e cornice

Table top Ripiano									
	CFC_BI	4519	527	3471	2810	3445	3447	4529	1952
Frame Telaio									
	BI100E	BE100E	GAE	BI200E	MGE	BE100E	BE200E	NPE	
Frame under the top Telaio sotto il ripiano									
	BI100E	BI100E	NPE	BI200E	MGE	BI100E	NPE		

BABILA table - Outdoor



Fixed tables / Tavoli fissi

VAT NOT INCLUDED / Iva esclusa

Tables / Tavoli



Frame Telaio			Composite marble top included Incluso ripiano in agglomerato di marmo		Gres top included Incluso ripiano in gres	
Item Articolo	Sizes Dimensioni	Finish Finitura	MFP (mm 12)	MBR (mm 12)	WFN, GFN (mm 6)	IDN (mm 6)
TBA/2_160X90	1590X900		€ 3.015,00	€ 3.172,00	-	-
TBA/2_200X90	2000X900		€ 3.210,00	€ 3.367,00	-	-
TBA/2_200X100	2000X1000		€ 3.210,00	€ 3.367,00	€ 2.915,00	€ 3.072,00
TBA/2_240X100	2400X1000		€ 3.494,00	€ 3.651,00	€ 3.058,00	€ 3.215,00
TBA/2_300X100	3000X1000		€ 3.871,00	€ 4.028,00	-	-

TECHNICAL DETAILS / Dettagli tecnici

Item TBA/2_160/200X90



Item TBA/2_200/240/300X100



Prices refer to combinations provided for the pricelist. Other standard powder-coated finishes available on request, price surcharge € 158,00 (each table)
I prezzi si riferiscono alle combinazioni previste a listino. Disponibili a richiesta altri colori standard di verniciatura, supplemento € 158,00 (a tavolo)

Top, frame and frame top finishes Finiture ripiano, telaio e cornice

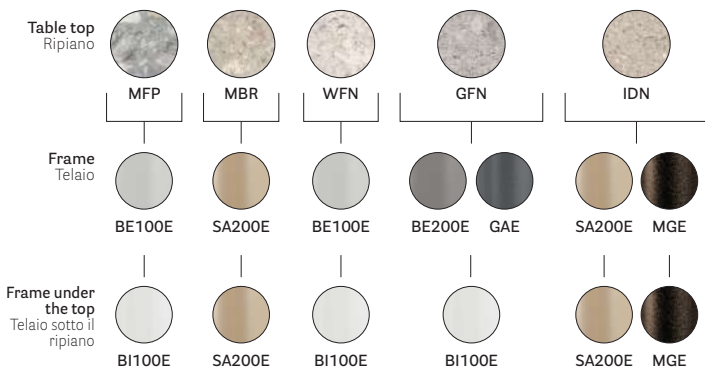

BABILA table - Outdoor



Fixed tables / Tavoli fissi

VAT NOT INCLUDED / Iva esclusa

Tables / Tavoli



Frame Telaio			Solid laminate top included Incluso ripiano in stratificato						
Item Articolo	Sizes Dimensioni	Finish Finitura	CFC_BI (mm 12) white core anima bianca	COM 4519 (mm 10) brown core anima marrone	COM 4529 (mm 10) black core anima nera	COM 2810 (mm 12) black core anima nera	CFP 3445 (mm 10) matching core anima in tinta	CFP 3447 (mm 10) matching core anima in tinta	COM 3471 (mm 10) beige core anima beige
TBA/2_139X139	1384X1384	Powder coated Verniciato	€ 1.982,00	€ 1.872,00	€ 1.872,00	€ 1.750,00	€ 2.139,00	€ 1.982,00	€ 1.982,00
TBA/2_D139	Ø 1384		€ 1.962,00	€ 1.853,00	€ 1.853,00	€ 1.729,00	€ 2.119,00	€ 1.962,00	€ 1.962,00
TBA/2_D159	Ø 1590		€ 2.274,00	€ 2.038,00	€ 2.038,00	€ 1.869,00	€ 2.431,00	€ 2.274,00	€ 2.274,00

TECHNICAL DETAILS / Dettagli tecnici

Item TBA/2_139X139

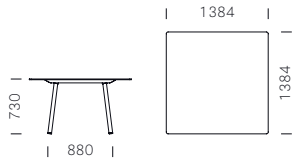

Item TBA/2_D139

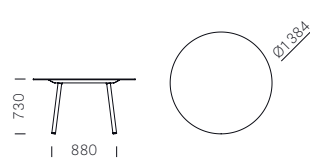

Item TBA/2_D159

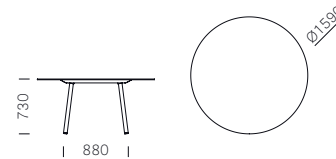

Prices refer to combinations provided for the pricelist. Other standard powder-coated finishes available on request, price surcharge € 158,00 (each table)
I prezzi si riferiscono alle combinazioni previste a listino. Disponibili a richiesta altri colori standard di verniciatura, supplemento € 158,00 (a tavolo)

Top, frame and frame top finishes Finiture ripiano, telaio e cornice

Table top Ripiano								
	CFC_BI	4519	3471	2810	3445	3447	4529	
Frame Telaio								
	BI100E	BE100E	GAE	BI200E	MGE	BE100E	BE200E	NPE
Frame under the top Telaio sotto il ripiano								
	BI100E	BI100E	NPE	BI200E	MGE	BI100E	NPE	

BLUME H300

Coffee tables / Tavolini



Item Articolo	Frame Telaio	Finish Finitura	Solid laminate top included Incluso ripiano in stratificato				Composite marble top included Incluso ripiano in agglomerato di marmo	Marble top included Incluso ripiano in marmo
	Sizes Dimensioni		CFC_BI (mm 10)	FNP_NE (mm 10)	FNP_3452 (mm 10)	FNP_3455 (mm 10)	MFP, MBR, MPR, MRL (mm 12)	MBC, MED, MGC, MVG (mm 20)
BLTD_49X30	Ø490X300h	OA - BS - GG - NE	€ 413,00	€ 428,00	€ 441,00	€ 489,00	€ 684,00	€ 700,00
BLTD_89X30	Ø890X300h	OA - BS - GG - NE	€ 606,00	€ 657,00	€ 699,00	€ 852,00	€ 1.161,00	€ 1.300,00
BLT_50X35X30	500X350X300h	OA - BS - GG - NE	€ 376,00	€ 388,00	€ 397,00	€ 431,00	€ 670,00	€ 771,00
BLT_90X60X30	900X600X300h	OA - BS - GG - NE	€ 519,00	€ 552,00	€ 579,00	€ 686,00	€ 961,00	€ 1.118,00
BLT_69X69X30	690X690X300h	OA - BS - GG - NE	€ 493,00	€ 524,00	€ 549,00	€ 641,00	€ 944,00	€ 998,00
BLT_99X99X30	990X990X300h	OA - BS - GG - NE	€ 667,00	€ 728,00	€ 779,00	€ 972,00	€ 1.234,00	€ 1.573,00
BLT_100X25X30	1000X250X300h	OA - BS - GG - NE	€ 419,00	€ 435,00	€ 448,00	€ 496,00	€ 931,00	€ 985,00

TECHNICAL DETAILS / Dettagli tecnici

Item BLTD_49X30*



Item BLTD_89X30*

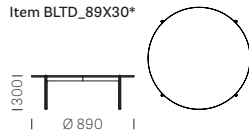

Item BLT_69X69X30*



Item BLT_99X99X30*

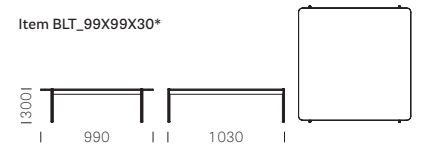

Item BLT_50X35X30*



Item BLT_90X60X30*



Item BLT_100X25X30*



* Table height increases of 1 cm for marble top versions
L'altezza del tavolo aumenta di 1 cm per le versioni con ripiano in marmo

Solid laminate top finishes Finiture ripiano in stratificato

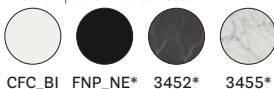

*Anti-fingerprint finish
Finitura anti-impronta

Composite marble top finishes Finiture ripiano in agglomerato di marmo

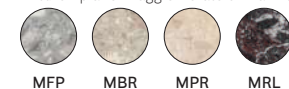

Marble top finishes Finiture ripiano in marmo

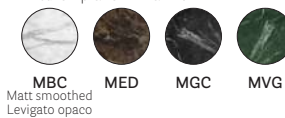

Matt smoothed
Levigato opaco

Frame finishes Finiture telaio



BLUME H370

Coffee tables / Tavolini



Item Articolo	Frame Telaio		Solid laminate top included Incluso ripiano in stratificato				Composite marble top included Incluso ripiano in agglomerato di marmo	Marble top included Incluso ripiano in marmo
	Sizes Dimensioni	Finish Finitura	CFC_BI (mm 10)	FNP_NE (mm 10)	FNP_3452 (mm 10)	FNP_3455 (mm 10)	MFP, MBR, MPR, MRL (mm 12)	MBC, MED, MGC, MVG (mm 20)
BLTD_49X37	Ø490X370h	OA - BS - GG - NE	€ 435,00	€ 449,00	€ 462,00	€ 510,00	€ 705,00	€ 721,00
BLTD_89X37	Ø890X370h	OA - BS - GG - NE	€ 627,00	€ 679,00	€ 719,00	€ 874,00	€ 1.183,00	€ 1.323,00
BLT_50X35X37	500X350X370h	OA - BS - GG - NE	€ 398,00	€ 410,00	€ 418,00	€ 453,00	€ 691,00	€ 793,00
BLT_90X60X37	900X600X370h	OA - BS - GG - NE	€ 540,00	€ 574,00	€ 601,00	€ 706,00	€ 983,00	€ 1.141,00
BLT_69X69X37	690X690X370h	OA - BS - GG - NE	€ 515,00	€ 545,00	€ 570,00	€ 662,00	€ 965,00	€ 1.020,00
BLT_99X99X37	990X990X370h	OA - BS - GG - NE	€ 689,00	€ 749,00	€ 801,00	€ 992,00	€ 1.256,00	€ 1.594,00
BLT_100X25X37	1000X250X370h	OA - BS - GG - NE	€ 441,00	€ 455,00	€ 470,00	€ 518,00	€ 952,00	€ 1.007,00

TECHNICAL DETAILS / Dettagli tecnici

Item BLTD_49X37*



Item BLTD_89X37*

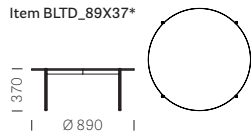

Item BLT_69X69X37*



Item BLT_99X99X37*

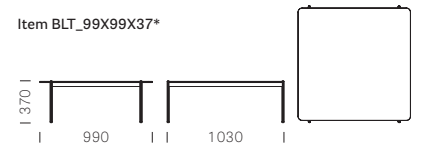

Item BLT_50X35X37*



Item BLT_90X60X37*



Item BLT_100X25X37*



* Table height increases of 1 cm for marble top versions
L'altezza del tavolo aumenta di 1 cm per le versioni con ripiano in marmo

Solid laminate top finishes Finiture ripiano in stratificato



*Anti-fingerprint finish
Finitura anti-impronta

Composite marble top finishes Finiture ripiano in agglomerato di marmo

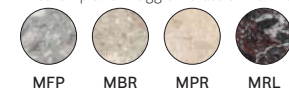

Marble top finishes Finiture ripiano in marmo

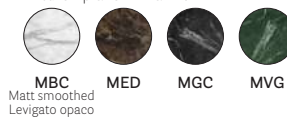

Matt smoothed
Levigato opaco

Frame finishes Finiture telaio

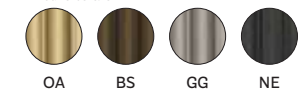

BLUME H450

Coffee tables / Tavolini



Item Articolo	Frame Telaio	Finish Finitura	Solid laminate top included Incluso ripiano in stratificato				Composite marble top included Incluso ripiano in agglomerato di marmo	Marble top included Incluso ripiano in marmo
	Sizes Dimensioni		CFC_BI (mm 10)	FNP_NE (mm 10)	FNP_3452 (mm 10)	FNP_3455 (mm 10)	MFP, MBR, MPR, MRL (mm 12)	MBC, MED, MGC, MVG (mm 20)
BLTD_49X45	Ø490X450h	OA - BS - GG - NE	€ 454,00	€ 470,00	€ 483,00	€ 530,00	€ 726,00	€ 740,00
BLTD_89X45	Ø890X450h	OA - BS - GG - NE	€ 648,00	€ 699,00	€ 740,00	€ 894,00	€ 1.203,00	€ 1.341,00
BLT_50X35X45	500X350X450h	OA - BS - GG - NE	€ 418,00	€ 429,00	€ 439,00	€ 472,00	€ 710,00	€ 813,00
BLT_90X60X45	900X600X450h	OA - BS - GG - NE	€ 561,00	€ 593,00	€ 621,00	€ 727,00	€ 1.003,00	€ 1.160,00
BLT_69X69X45	690X690X450h	OA - BS - GG - NE	€ 535,00	€ 565,00	€ 591,00	€ 683,00	€ 985,00	€ 1.039,00
BLT_99X99X45	990X990X450h	OA - BS - GG - NE	€ 709,00	€ 770,00	€ 821,00	€ 1.013,00	€ 1.276,00	€ 1.614,00
BLT_100X25X45	1000X250X450h	OA - BS - GG - NE	€ 461,00	€ 476,00	€ 489,00	€ 536,00	€ 973,00	€ 1.026,00

TECHNICAL DETAILS / Dettagli tecnici

Item BLTD_49X45*



Item BLTD_89X45*

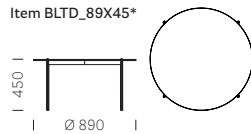

Item BLT_69X69X45*



Item BLT_99X99X45*

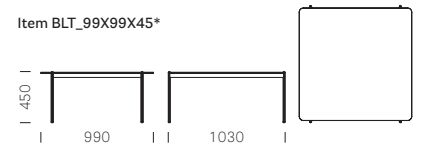

Item BLT_50X35X45*



Item BLT_90X60X45*



Item BLT_100X25X45*



* Table height increases of 1 cm for marble top versions
L'altezza del tavolo aumenta di 1 cm per le versioni con ripiano in marmo

Solid laminate top finishes Finiture ripiano in stratificato

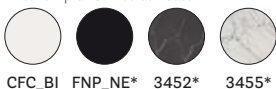

*Anti-fingerprint finish
Finitura anti-impronta

Composite marble top finishes Finiture ripiano in agglomerato di marmo

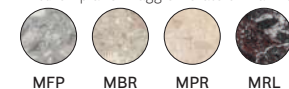

Marble top finishes Finiture ripiano in marmo

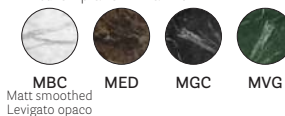

Matt smoothed
Levigato opaco

Frame finishes Finiture telaio

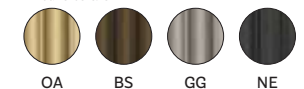

BUDDY

Coffee tables / Tavolini



Item Articolo	Frame Telaio		Solid laminate top included Incluso ripiano in stratificato					
	Sizes Dimensioni	Finish Finitura	CFP_BI (mm 10)	FNP_NE (mm 10)	FNP_3452 (mm 10)	FNP_3455 (mm 10)	COP_3457 (mm 10)	COP_3471 (mm 10)
BDTD_79X26	Ø790X250h	POWDER COATED / Verniciato	€ 442,00	€ 442,00	€ 514,00	€ 676,00	€ 364,00	€ 449,00
BDTD_79X32	Ø790X310h	OA - TN	€ 605,00	€ 605,00	€ 676,00	€ 839,00	€ 527,00	€ 611,00
BDTD_89X26	Ø890X250h	POWDER COATED / Verniciato	€ 514,00	€ 514,00	€ 572,00	€ 761,00	€ 416,00	€ 527,00
BDTD_89X32	Ø890X310h	OA - TN	€ 676,00	€ 676,00	€ 735,00	€ 923,00	€ 579,00	€ 689,00
BDTD_99X26	Ø990X250h	POWDER COATED / Verniciato	€ 592,00	€ 592,00	€ 650,00	€ 871,00	€ 475,00	€ 605,00
BDTD_99X32	Ø990X310h	OA - TN	€ 754,00	€ 754,00	€ 813,00	€ 1.034,00	€ 637,00	€ 767,00
BDT_59X59X26	590X590X250h	POWDER COATED / Verniciato	€ 325,00	€ 325,00	€ 338,00	€ 416,00	€ 280,00	€ 325,00
BDT_59X59X32	590X590X310h	OA - TN	€ 488,00	€ 488,00	€ 501,00	€ 579,00	€ 442,00	€ 488,00
BDT_79X79X26	790X790X250h	POWDER COATED / Verniciato	€ 442,00	€ 442,00	€ 514,00	€ 676,00	€ 364,00	€ 449,00
BDT_79X79X32	790X790X310h	OA - TN	€ 605,00	€ 605,00	€ 676,00	€ 839,00	€ 527,00	€ 611,00
BDT_89X89X26	890X890X250h	POWDER COATED / Verniciato	€ 514,00	€ 514,00	€ 572,00	€ 761,00	€ 416,00	€ 527,00
BDT_89X89X32	890X890X310h	OA - TN	€ 676,00	€ 676,00	€ 735,00	€ 923,00	€ 579,00	€ 689,00
BDT_99X99X26	990X990X250h	POWDER COATED / Verniciato	€ 592,00	€ 592,00	€ 650,00	€ 871,00	€ 475,00	€ 605,00
BDT_99X99X32	990X990X310h	OA - TN	€ 754,00	€ 754,00	€ 813,00	€ 1.034,00	€ 637,00	€ 767,00
BDT_109X109X26	1090X1090X250h	POWDER COATED / Verniciato	€ 683,00	€ 683,00	€ 728,00	€ 988,00	€ 540,00	€ 696,00
BDT_109X109X32	1090X1090X310h	OA - TN	€ 845,00	€ 845,00	€ 891,00	€ 1.151,00	€ 702,00	€ 858,00
BDT_119X119X26	1190X1190X250h	POWDER COATED / Verniciato	€ 845,00	€ 845,00	€ 910,00	€ 1.248,00	€ 663,00	€ 865,00
BDT_119X119X32	1190X1190X310h	OA - TN	€ 1.008,00	€ 1.008,00	€ 1.073,00	€ 1.411,00	€ 826,00	€ 1.027,00
BDT_79X40X26	790X400X250h	POWDER COATED / Verniciato	€ 312,00	€ 312,00	€ 332,00	€ 403,00	€ 267,00	€ 312,00
BDT_79X40X32	790X400X310h	OA - TN	€ 475,00	€ 475,00	€ 494,00	€ 566,00	€ 429,00	€ 475,00
BDT_120X59X26	1200X590X250h	POWDER COATED / Verniciato	€ 507,00	€ 507,00	€ 527,00	€ 676,00	€ 416,00	€ 514,00
BDT_120X59X32	1200X590X310h	OA - TN	€ 670,00	€ 670,00	€ 689,00	€ 839,00	€ 579,00	€ 676,00

TECHNICAL DETAILS / Dettagli tecnici

Item BDTD_79X26/32



Item BDTD_89X26/32



Item BDTD_99X26/32



Item BDT_59X59X26/32



Item BDT_79X79X26/32



Item BDT_89X89X26/32



Item BDT_99X99X26/32



Item BDT_109X109X26/32



Item BDT_119X119X26/32



Item BDT_79X40X26/32



Item BDT_120X59X26/32



Solid laminate top finishes Finiture ripiano in stratificato

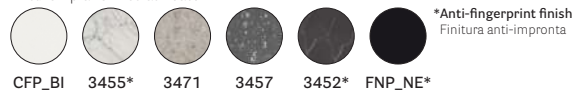

*Anti-fingerprint finish
Finitura anti-impronta



Item Articolo	Frame Telaio		Solid laminate top included Incluso ripiano in stratificato				
	Sizes Dimensioni	Finish Finitura	CFP_BI (mm 10)	COP_247, 527 (mm 10)	COP_4519, 4543 (mm 10)	COP_3471, 3467 (mm 10)	CFP_3445, 3447 (mm 10)
BDTD_79X26 BDTD_79X32	Ø790X250h Ø790X310h	POWDER COATED / Verniciato	€ 468,00	€ 338,00	€ 390,00	€ 475,00	€ 475,00
BDTD_89X26 BDTD_89X32	Ø890X250h Ø890X310h	POWDER COATED / Verniciato	€ 540,00	€ 384,00	€ 442,00	€ 553,00	€ 553,00
BDTD_99X26 BDTD_99X32	Ø990X250h Ø990X310h	POWDER COATED / Verniciato	€ 618,00	€ 423,00	€ 501,00	€ 631,00	€ 631,00
BDT_59X59X26 BDT_59X59X32	590X590X250h 590X590X310h	POWDER COATED / Verniciato	€ 351,00	€ 280,00	€ 306,00	€ 351,00	€ 351,00
BDT_79X79X26 BDT_79X79X32	790X790X250h 790X790X310h	POWDER COATED / Verniciato	€ 468,00	€ 338,00	€ 390,00	€ 475,00	€ 475,00
BDT_89X89X26 BDT_89X89X32	890X890X250h 890X890X310h	POWDER COATED / Verniciato	€ 540,00	€ 384,00	€ 442,00	€ 553,00	€ 553,00
BDT_99X99X26 BDT_99X99X32	990X990X250h 990X990X310h	POWDER COATED / Verniciato	€ 618,00	€ 423,00	€ 501,00	€ 631,00	€ 631,00
BDT_109X109X26 BDT_109X109X32	1090X1090X250h 1090X1090X310h	POWDER COATED / Verniciato	€ 709,00	€ 468,00	€ 566,00	€ 722,00	€ 722,00
BDT_119X119X26 BDT_119X119X32	1190X1190X250h 1190X1190X310h	POWDER COATED / Verniciato	€ 871,00	€ 559,00	€ 689,00	€ 891,00	€ 891,00
BDT_79X40X26 BDT_79X40X32	790X400X250h 790X400X310h	POWDER COATED / Verniciato	€ 338,00	€ 275,00	€ 293,00	€ 338,00	€ 338,00
BDT_120X59X26 BDT_120X59X32	1200X590X250h 1200X590X310h	POWDER COATED / Verniciato	€ 533,00	€ 385,00	€ 442,00	€ 540,00	€ 540,00

TECHNICAL DETAILS / Dettagli tecnici

Item BDTD_79X26/32



Item BDTD_89X26/32



Item BDTD_99X26/32



Item BDT_59X59X26/32



Item BDT_79X79X26/32



Item BDT_89X89X26/32



Item BDT_99X99X26/32



Item BDT_109X109X26/32



Item BDT_119X119X26/32



Item BDT_79X40X26/32



Item BDT_120X59X26/32



Solid laminate top finishes Finiture ripiano in stratificato



BUDDY marble

Coffee tables / Tavolini



Item Articolo	Frame Telaio		Marble top included Incluso ripiano in marmo	Composite marble top included Incluso ripiano in agglomerato di marmo
	Sizes Dimensioni	Finish Finitura	MBC, MED, MGC, MVG (mm 20)	MFP, MPR, MBR (mm 12)
BDT_59X59X26 BDT_59X59X32	590X590X260h	POWDER COATED / Verniciato	€ 783,00	€ 673,00
	590X590X320h	OA - TN	€ 946,00	€ 809,00
BDT_79X79X26 BDT_79X79X32	790X790X260h	POWDER COATED / Verniciato	€ 1.121,00	€ 1.011,00
	790X790X320h	OA - TN	€ 1.284,00	€ 1.147,00

Price includes a compact laminate support 6 mm thickness
Il prezzo include un ripiano di supporto in stratificato spessore 6 mm

TECHNICAL DETAILS / Dettagli tecnici

Item BDT_59X59X26*



Item BDT_59X59X32*



Item BDT_79X79X26*

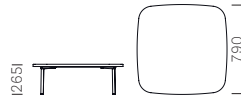

Item BDT_79X79X32*

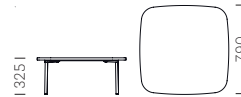

* Table height decreases of 1 cm for composite marble top versions
L'altezza del tavolo si riduce di 1 cm per le versioni con ripiano in agglomerato di marmo

Marble top finishes Finiture ripiano marmo

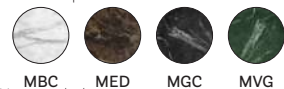

MBC MED MGC MVG
Matt smoothed
Levigato opaco

Composite marble top finishes Finiture ripiano in agglomerato di marmo

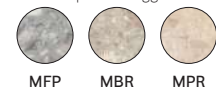

MFP MBR MPR

BUDDYHUB DESK

Fixed tables / Tavoli fissi



Frame
Telaio

Solid laminate top included
Incluso ripiano in stratificato

Item Articolo	Finish Finitura	Fabric Tessuto	CFP_BI (mm 10)	FNP_NE (mm 10)	COP_527, 4529 (mm 10)	Fittings Accessori
BDS001/140 Temporary workstation Postazione temporanea	POWDER COATED / Verniciato	D40+D44	€ 3.036,00	€ 3.036,00	€ 3.036,00	-
		E	€ 3.374,00	€ 3.374,00	€ 3.374,00	
		G	€ 3.374,00	€ 3.374,00	€ 3.374,00	
		H*	€ 2.958,00	€ 2.958,00	€ 2.958,00	
		N	€ 3.439,00	€ 3.439,00	€ 3.439,00	
BDS001/140_FSX Temporary workstation with cable management Postazione temporanea con canalina	POWDER COATED / Verniciato	D40+D44	€ 3.062,00	€ 3.062,00	€ 3.062,00	-
		E	€ 3.400,00	€ 3.400,00	€ 3.400,00	
		G	€ 3.400,00	€ 3.400,00	€ 3.400,00	
		H*	€ 2.984,00	€ 2.984,00	€ 2.984,00	
		N	€ 3.465,00	€ 3.465,00	€ 3.465,00	
ME/00183 (EU) Pop-up socket Presse elettrica a scomparsa						€ 429,00
ME/00185 (UK) Pop-up socket Presse elettrica a scomparsa						€ 507,00
BDS002/140 Workstation Postazione operativa	POWDER COATED / Verniciato	D40+D44	€ 3.822,00	€ 3.822,00	€ 3.822,00	-
		E	€ 4.251,00	€ 4.251,00	€ 4.251,00	
		G	€ 4.251,00	€ 4.251,00	€ 4.251,00	
		H*	€ 3.725,00	€ 3.725,00	€ 3.725,00	
		N	€ 4.342,00	€ 4.342,00	€ 4.342,00	
BDS002/140_CCO Workstation with cable management Postazione operativa con canalina	POWDER COATED / Verniciato	D40+D44	€ 4.004,00	€ 4.004,00	€ 4.004,00	-
		E	€ 4.433,00	€ 4.433,00	€ 4.433,00	
		G	€ 4.433,00	€ 4.433,00	€ 4.433,00	
		H*	€ 3.907,00	€ 3.907,00	€ 3.907,00	
		N	€ 4.524,00	€ 4.524,00	€ 4.524,00	
BD01 Coat hanger Gancio appendiabiti	POWDER COATED / Verniciato					€ 78,00
BD02 Magazine holder Portariviste	POWDER COATED / Verniciato					€ 156,00

*Excluding / Escluso H82+H89, H20+H35; H100+H108

For fabrics see page 284
Per i tessuti si veda p. 284

TECHNICAL DETAILS / Dettagli tecnici

Item BDS001/140

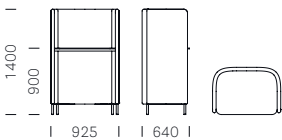

Item BDS001/140_FSX

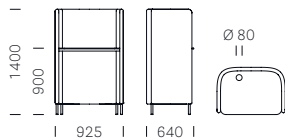

Item BDS002/140

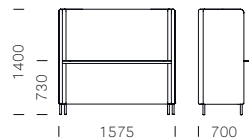

Item BDS002/140_CCO

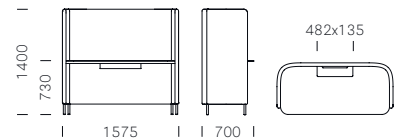

Item BD01



Item BD02

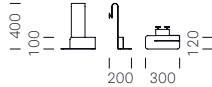

Item ME/00183 (EU)

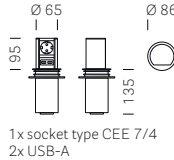

Item ME/00185 (UK)

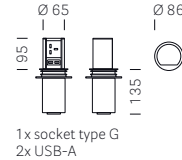

Solid laminate top finishes
Finiture ripiano in stratificato

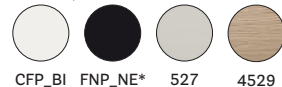

*Anti-fingerprint finish
Finitura anti-impronta



Item Articolo	Sizes Dimensioni	Finish Finitura	Price Prezzo
CMT_40X30X35	400X300X350h	CONCRETE Cemento	€ 457,00
CMT_46X35X42	460X350X420h	CONCRETE Cemento	€ 714,00

TECHNICAL DETAILS / Dettagli tecnici

Item CMT_40x30x35

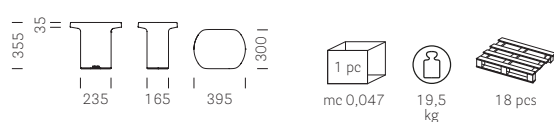

Item CMT_46x35x42

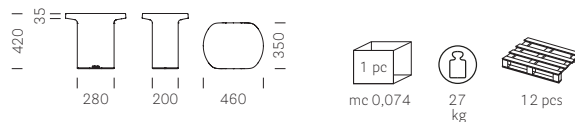

Concrete finishes Finiture cemento



CIRCUIT

Coffee tables / Tavolini



Item Articolo	Frame Telaio Sizes Dimensioni	Finish Finitura	Solid laminate top included Incluso ripiano in stratificato						
			CFP_BI, FNP_NE (mm 10)	FNP_3452 (mm 10)	FNP_3455 (mm 10)	COP_4511, 4512, 4517, 4519, 4529, 4543, 4575, 1952, 4420, 4384 (mm 10)	COP_3457 (mm 10)	COP_2810, white bianco, 851, 263, 526 (mm 12)	COP_3471, 3467 (mm 10)
CRTD_42X45	Ø420X450h	POWDER COATED / Verniciato	€ 215,00	€ 215,00	€ 247,00	€ 189,00	€ 189,00	€ 189,00	€ 215,00
		OA - TN	€ 319,00	€ 319,00	€ 351,00	€ 293,00	€ 293,00	€ 293,00	€ 319,00
CRTD_59X25	Ø590X250h	POWDER COATED / Verniciato	€ 299,00	€ 309,00	€ 384,00	€ 259,00	€ 259,00	€ 259,00	€ 299,00
		OA - TN	€ 403,00	€ 413,00	€ 488,00	€ 363,00	€ 363,00	€ 363,00	€ 403,00
CRTD_70X30	Ø700X300h	POWDER COATED / Verniciato	€ 371,00	€ 397,00	€ 507,00	€ 325,00	€ 325,00	€ 325,00	€ 371,00
		OA - TN	€ 481,00	€ 507,00	€ 618,00	€ 436,00	€ 436,00	€ 436,00	€ 481,00

TECHNICAL DETAILS / Dettagli tecnici

Item CRTD_42X45



Item CRTD_59X25

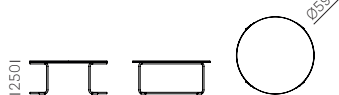

Item CRTD_70X30

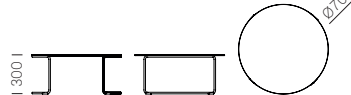

Solid laminate top finishes
Finiture ripiano in stratificato

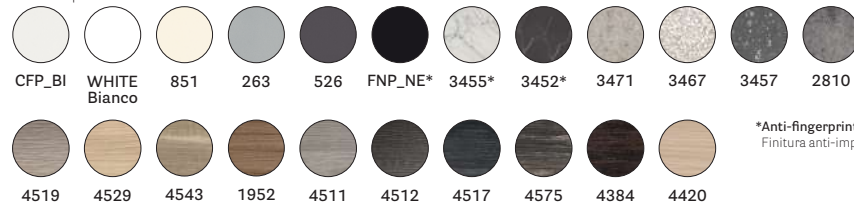

*Anti-fingerprint
Finitura anti-impronta



Item Articolo	Frame Telaio		Solid laminate top included Incluso ripiano in stratificato						Steel top included Incluso ripiano in lamiera
	Sizes Dimensioni	Finish Finitura	CFP_BI (mm 10)	COP_247, 527 (mm 10)	COP_4519, 4529, 4543, 4573, 1952, 4420 (mm 10)	COP_2810, white bianco, 851, 263 (mm 12) COP_3294 (mm 10)	COP_3471, 3467 (mm 10)	CFP_3445, 3447 (mm 10)	L* (mm 12)
CRTD_42X45	Ø420X450h	POWDER COATED / Verniciato	€ 241,00	€ 215,00	€ 215,00	€ 215,00	€ 241,00	€ 241,00	-
CRTD_59X25	Ø590X250h	POWDER COATED / Verniciato	€ 325,00	€ 260,00	€ 285,00	€ 285,00	€ 325,00	€ 325,00	€ 387,00
CRTD_70X30	Ø700X300h	POWDER COATED / Verniciato	€ 397,00	€ 312,00	€ 351,00	€ 351,00	€ 397,00	€ 397,00	€ 415,00

TECHNICAL DETAILS / Dettagli tecnici

Item CRTD_42X45



Item CRTD_59X25

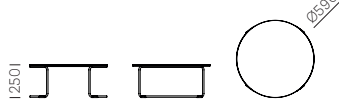

Item CRTD_70X30

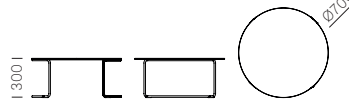

Solid laminate top finishes
Finiture ripiano in stratificato

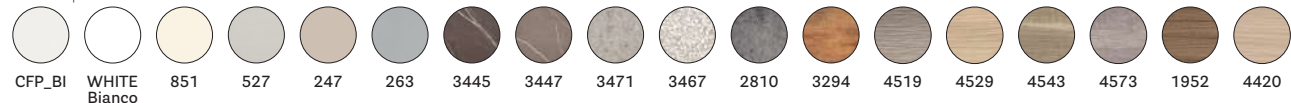

*Steel top and frame finishes in the same colour
Finiture ripiano in lamiera e telaio in tinta

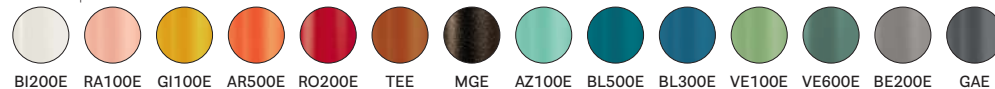

CODE

Coffee tables / Tavolini



Item Articolo	Frame Telaio	Finish Finitura	Solid laminate top included Incluso ripiano in stratificato	
	Sizes Dimensioni		CFP_BI, FNP_NE (mm 10)	CFP_BI (mm 10)
CODE_40X40X30	400X400X300h	POWDER COATED / Verniciato	€ 236,00	€ 277,00
CODE_40X40X60	400X400X600h	POWDER COATED / Verniciato	€ 270,00	€ 311,00
CODE_50X50X36	500X500X360h	POWDER COATED / Verniciato	€ 311,00	€ 361,00
CODE_59X59X42	590X590X420h	POWDER COATED / Verniciato	€ 372,00	€ 423,00
CODE_119X59X30	1190X590X300h	POWDER COATED / Verniciato	€ 653,00	€ 710,00
SET_CODE	400X400X300h 500X500X360h 590X590X420h	POWDER COATED / Verniciato	€ 916,00	€ 1.057,00

TECHNICAL DETAILS / Dettagli tecnici

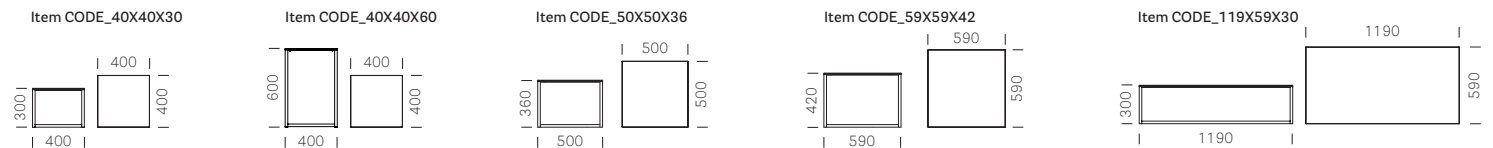

Solid laminate top finishes
Finiture ripiano in stratificato



CODE marble

Coffee tables / Tavolini



Item Articolo	Frame Telaio	Finish Finitura	Marble top included Incluso ripiano in marmo
	Sizes Dimensioni		MBC, MED, MGC, MVG (mm 20)
CODE_40X40X30	400X400X300h	POWDER COATED / Verniciato	€ 489,00
CODE_40X40X60	400X400X600h	POWDER COATED / Verniciato	€ 523,00
CODE_50X50X36	500X500X360h	POWDER COATED / Verniciato	€ 574,00
CODE_59X59X42	590X590X420h	POWDER COATED / Verniciato	€ 688,00
CODE_119X59X30	1190X590X300h	POWDER COATED / Verniciato	€ 1.176,00

TECHNICAL DETAILS / Dettagli tecnici

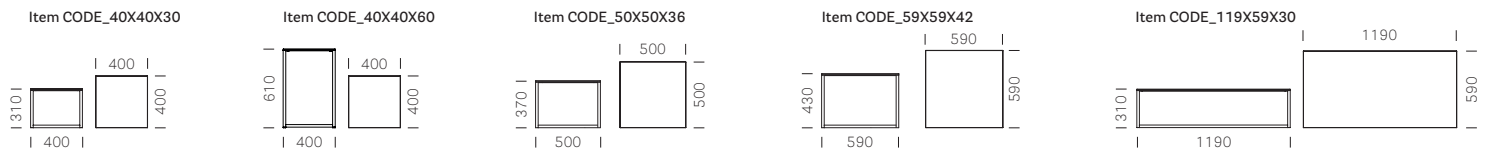

Marble top finishes Finiture ripiano in marmo

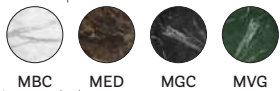

MBC MED MGC MVG
Matt smoothed
Levigato opaco

ELINOR table

Fixed tables / Tavoli fissi



Item Articolo	Frame Telaio Sizes Dimensioni	Finish Finitura	Solid laminate top included Incluso ripiano in stratificato					Glass top included Incluso ripiano in vetro	
			CFP_BI (mm 6)	FNP_NE (mm 6)	COM 527, 234, 623 (mm 6)	FNP_3452 (mm 6)	FNP_3455 (mm 6)	BIAL (mm 8)	
ELN150X150	1500X1500	C130+C141	€ 4.894,00	€ 4.894,00	€ 4.894,00	-	-	€ 5.444,00	
		H20+H35; H100+H108	€ 4.956,00	€ 4.956,00	€ 4.956,00	-	-	€ 5.506,00	
		P	€ 5.554,00	€ 5.554,00	€ 5.554,00	-	-	€ 6.104,00	
ELN200X110	2000X1100	C130+C141	€ 4.729,00	€ 4.807,00	€ 4.807,00	€ 4.886,00	€ 5.263,00	€ 5.593,00	
		H20+H35; H100+H108	€ 4.791,00	€ 4.869,00	€ 4.869,00	€ 4.948,00	€ 5.325,00	€ 5.655,00	
		P	€ 5.389,00	€ 5.467,00	€ 5.467,00	€ 5.546,00	€ 5.923,00	€ 6.253,00	
ELN260X110	2600X1100	C130+C141	€ 5.696,00	€ 5.853,00	€ 5.853,00	€ 6.010,00	€ 6.545,00	€ 6.010,00	
		H20+H35; H100+H108	€ 5.758,00	€ 5.915,00	€ 5.915,00	€ 6.073,00	€ 6.607,00	€ 6.073,00	
		P	€ 6.356,00	€ 6.513,00	€ 6.513,00	€ 6.671,00	€ 7.205,00	€ 6.671,00	
ELN300X110	3000X1100	C130+C141	€ 6.175,00	€ 6.333,00	€ 6.333,00	€ 6.490,00	€ 7.104,00	-	
		H20+H35; H100+H108	€ 6.238,00	€ 6.395,00	€ 6.395,00	€ 6.552,00	€ 7.166,00	-	
		P	€ 6.836,00	€ 6.993,00	€ 6.993,00	€ 7.150,00	€ 7.764,00	-	

TECHNICAL DETAILS / Dettagli tecnici

Item ELN150X150

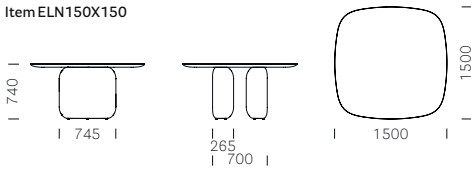

Item ELN200/260/300X110



For fabrics see page 284
Per i tessuti si veda p. 284

Solid laminate top finishes
Finiture ripiano in stratificato

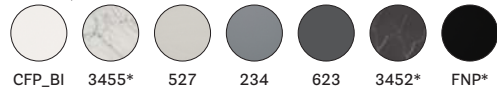

*Anti-fingerprint finish
Finitura anti-impronta

Glass top finishes
Finiture ripiano in vetro



White shiny lacquered
Laccato bianco lucido

Examples of BASES combinations / Esempi di configurazione BASI



Examples of combinations
Esempi di abbinamenti

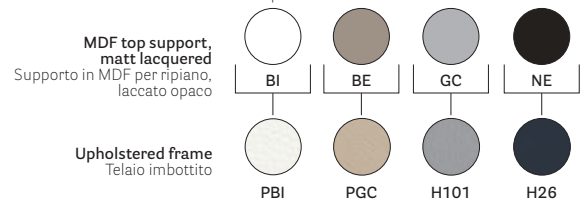

On request MDF support available stained-sample, surcharge € 80,00 (each table)
Disponibile a richiesta il supporto in MDF tinto campione, supplemento € 80,00 (a tavolo)

ELINOR table

Fixed tables - with cable management / Tavoli fissi - con canalina

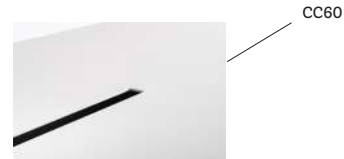

Item Articolo	Frame Telaio Sizes Dimensioni	Finish Finitura	Cable management Canalina	Solid laminate top included Incluso ripiano in stratificato				
				CFP_BI (mm 6)	FNP_NE (mm 6)	COM 527, 234, 623 (mm 6)	FNP_3452 (mm 6)	FNP_3455 (mm 6)
ELN150X150 CC60	1500X1500	C130+C141	CC60	€ 5.051,00	€ 5.051,00	€ 5.051,00	-	-
		H20+H35; H100+H108		€ 5.113,00	€ 5.113,00	€ 5.113,00	-	-
		P		€ 5.711,00	€ 5.711,00	€ 5.711,00	-	-
ELN200X110 CC60	2000X1100	C130+C141	CC60	€ 4.886,00	€ 4.964,00	€ 4.964,00	€ 5.043,00	€ 5.420,00
		H20+H35; H100+H108		€ 4.948,00	€ 5.026,00	€ 5.026,00	€ 5.106,00	€ 5.483,00
		P		€ 5.546,00	€ 5.624,00	€ 5.624,00	€ 5.704,00	€ 6.081,00
ELN260X110 CC60	2600X1100	C130+C141	CC60	€ 5.853,00	€ 6.010,00	€ 6.010,00	€ 6.168,00	€ 6.702,00
		H20+H35; H100+H108		€ 5.915,00	€ 6.073,00	€ 6.073,00	€ 6.230,00	€ 6.764,00
		P		€ 6.513,00	€ 6.671,00	€ 6.671,00	€ 6.828,00	€ 7.362,00
ELN300X110 CC60	3000X1100	C130+C141	CC60	€ 6.333,00	€ 6.490,00	€ 6.490,00	€ 6.647,00	€ 7.261,00
		H20+H35; H100+H108		€ 6.395,00	€ 6.552,00	€ 6.552,00	€ 6.710,00	€ 7.323,00
		P		€ 6.993,00	€ 7.150,00	€ 7.150,00	€ 7.308,00	€ 7.921,00

TECHNICAL DETAILS / Dettagli tecnici

Item ELN150X150 CC60

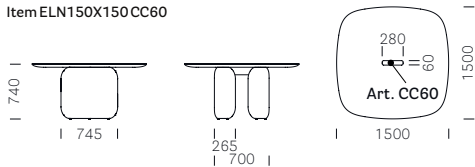

Item ELN200/260/300X110 CC60

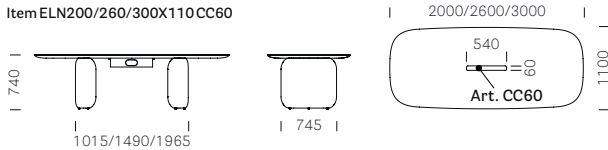

For fabrics see page 284
Per i tessuti si veda p. 284

Solid laminate top finishes
Finiture ripiano in stratificato

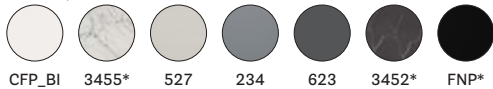

*Anti-fingerprint finish
Finitura anti-impronta

Examples of BASES combinations / Esempi di configurazione BASI



Examples of combinations
Esempi di abbinamenti

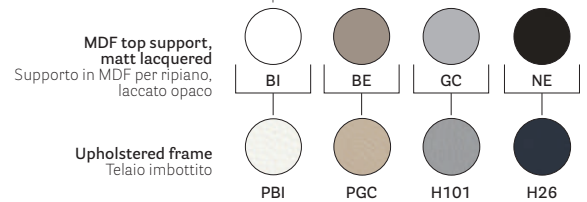

On request MDF support available stained-sample, surcharge € 80,00 (each table)
Disponibile a richiesta il supporto in MDF tinto campione, supplemento € 80,00 (a tavolo)

ELINOR table

Fixed tables - with cable management / Tavoli fissi - con canalina

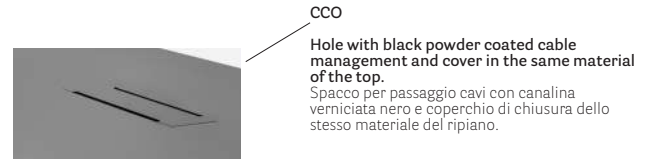

Item Articolo	Frame Telaio Sizes Dimensioni	Finish Finitura	Cable management Canalina	Solid laminate top included Incluso ripiano in stratificato		
				CFP_BI (mm 6)	FNP_NE (mm 6)	COM 527, 234, 623 (mm 6)
ELN150X150 CCO	1500X1500	C130+C141	CCO	€ 5.208,00	€ 5.208,00	€ 5.208,00
		H20+H35; H100+H108		€ 5.271,00	€ 5.271,00	€ 5.271,00
		P		€ 5.869,00	€ 5.869,00	€ 5.869,00
ELN200X110 CCO	2000X1100	C130+C141	CCO	€ 5.043,00	€ 5.121,00	€ 5.121,00
		H20+H35; H100+H108		€ 5.106,00	€ 5.184,00	€ 5.184,00
		P		€ 5.704,00	€ 5.782,00	€ 5.782,00
ELN260X110 CCO	2600X1100	C130+C141	CCO	€ 6.010,00	€ 6.168,00	€ 6.168,00
		H20+H35; H100+H108		€ 6.073,00	€ 6.230,00	€ 6.230,00
		P		€ 6.671,00	€ 6.828,00	€ 6.828,00
ELN300X110 CCO	3000X1100	C130+C141	CCO	€ 6.490,00	€ 6.647,00	€ 6.647,00
		H20+H35; H100+H108		€ 6.552,00	€ 6.710,00	€ 6.710,00
		P		€ 7.150,00	€ 7.308,00	€ 7.308,00

TECHNICAL DETAILS / Dettagli tecnici

Item ELN150X150 CCO

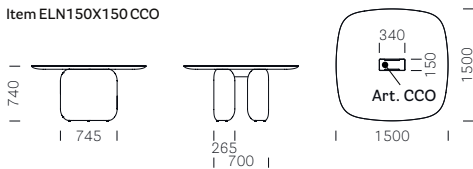

Item ELN200/260/300X110 CCO

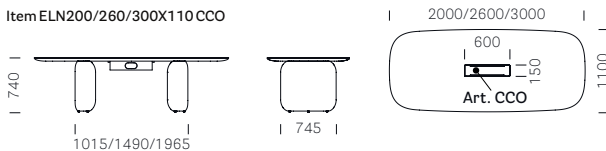

Examples of BASES combinations / Esempi di configurazione BASI



For fabrics see page 284
Per i tessuti si veda p. 284

Solid laminate top finishes Finiture ripiano in stratificato

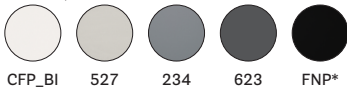

*Anti-fingerprint finish
Finitura anti-impronta

Examples of combinations Esempi di abbinamenti

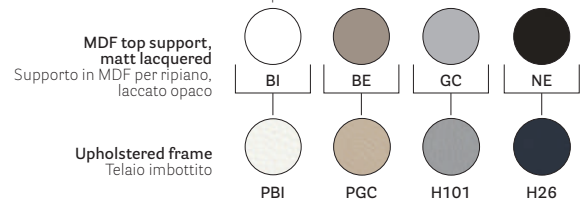

On request MDF support available stained-sample, surcharge € 80,00 (each table)
Disponibile a richiesta il supporto in MDF tinto campione, supplemento € 80,00 (a tavolo)



Item Articolo	Frame Telaio Finish Finitura	Top Ripiano Sizes Dimensioni	Gres top included Incluso ripiano in gres WFN, GFN, IDN (mm 6)
5477	BE100E - BE200E - SA200E	Ø 1190	€ 1.532,00

Price includes a white compact laminate support 10 mm thickness
Il prezzo include un ripiano di supporto in stratificato bianco spessore 10 mm

TECHNICAL DETAILS / Dettagli tecnici

Item 5477

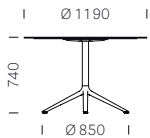

Gres top finishes
Finiture ripiano in gres



WFN GFN IDN

Frame finishes
Finiture telaio



BE100E BE200E SA200E

EXTESO

Extensible tables / Tavoli allungabili



Item Articolo	Frame Telaio	Finish Finitura	Top included Incluso ripiano
	Sizes Dimensioni		BI - RS - W
TE2_178X90	1780 → 2280 → 2780 (X900)	BI - RS - W	€ 3.222,00

TECHNICAL DETAILS / Dettagli tecnici

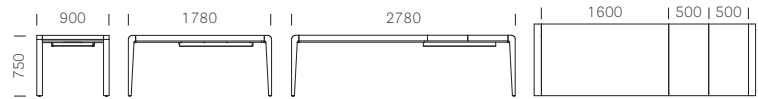

Finishes

Finiture

- BI**
White matt lacquered
Laccato bianco goffrato
- RS**
Bleached oak
Rovere sbiancato
- W**
Wenge stained oak
Rovere tinto wengé

FABBRICO



Fixed tables / Tavoli fissi



Item Articolo	Frame Telaio	Finish Finitura	Steel top included Incluso ripiano acciaio	
			TR 	BI100E - BI200E - GAE - BE200E - TEE - RUE - MGE - VE600E
TFA_70X70	700X700	TR	€ 381,00	-
		BI100E - BI200E - GAE - BE200E - TEE - RUE - MGE - VE600E	-	€ 346,00
TFA_80X80	800X800	TR	€ 397,00	-
		BI100E - BI200E - GAE - BE200E - TEE - RUE - MGE - VE600E	-	€ 361,00
TFA_100X100	1000X1000	BI100E - BI200E - GAE - BE200E - TEE - RUE - MGE - VE600E	-	€ 441,00
TFA120X80	1200X800	TR	€ 468,00	-
		BI100E - BI200E - GAE - BE200E - TEE - RUE - MGE - VE600E	-	€ 426,00
TFA160X80	1600X800	TR	€ 546,00	-
		BI100E - BI200E - GAE - BE200E - TEE - RUE - MGE - VE600E	-	€ 496,00

TECHNICAL DETAILS / Dettagli tecnici

Item TFA_70X70

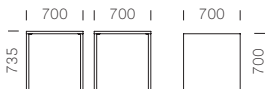

Stackable / Impilabile: 10 pcs/pz

Item TFA_80X80

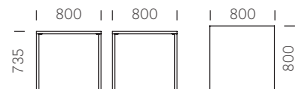

Stackable / Impilabile: 10 pcs/pz

Item TFA_100X100



Stackable / Impilabile: 10 pcs/pz

Item TFA120X80

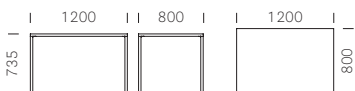

Item TFA160X80

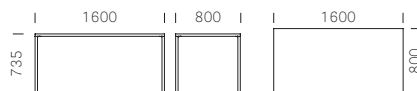

Finishes

Finiture

- TR
- BI100E
- BI200E
- GAE
- BE200E
- TEE
- RUE
- MGE
- VE600E

IKON table

Fixed tables / Tavoli fissi



Frame Telaio			Solid laminate top included Incluso ripiano in stratificato	
Item Articolo	Sizes Dimensioni	Finish Finitura	CFC_BI (mm 6)	FNP_NE (mm 6)
IKT240X100	2400X1000	POLYETHYLENE Polietilene	€ 2.578,00	€ 3.172,00
IKT240X120	2400X1200		€ 2.909,00	€ 3.503,00
IKT300X100	3000X1000		€ 2.992,00	€ 3.421,00
IKT300X120	3000X1200		€ 3.288,00	€ 3.717,00
IKT360X120	3600X1200		€ 3.702,00	€ 4.114,00

TECHNICAL DETAILS / Dettagli tecnici

Item IKT240/300X100

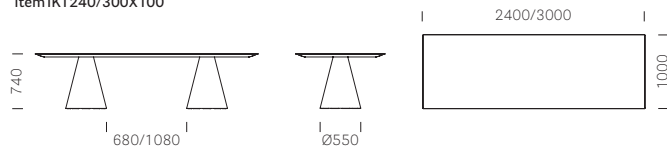

Item IKT240/300/360X120

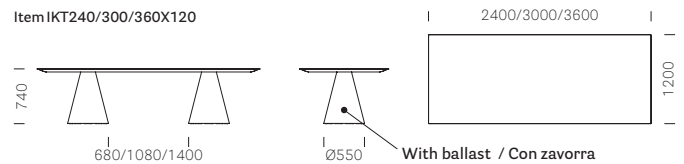

Top, frame and frame top finishes Finiture ripiano, telaio e cornice

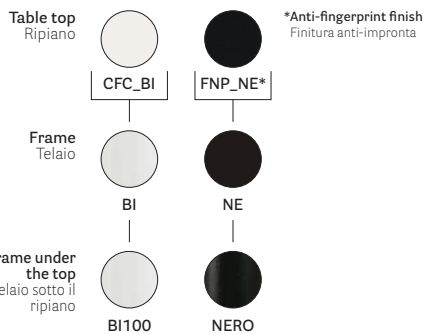

IKON table

Fixed tables - with cable management / Tavoli fissi - con canalina

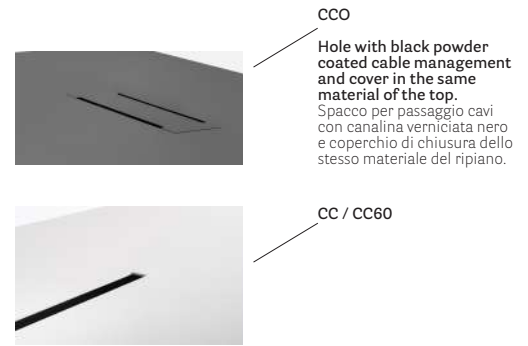

Frame Telaio			Solid laminate top included Incluso ripiano in stratificato		
Item Articolo	Sizes Dimensioni	Finish Finitura	Cable management Canalina	CFC_BI (mm 6)	FNP_NE (mm 6)
IKT300X100 CC	3000X1000	POLYETHYLENE Polietilene	CC (42 mm) *	€ 3.322,00	€ 3.751,00
IKT300X120 CC	3000X1200			€ 3.618,00	€ 4.047,00
IKT360X120 CC	3600X1200			€ 4.032,00	€ 4.444,00
IKT240X100 CCO	2400X1000	POLYETHYLENE Polietilene	CCO	€ 3.074,00	€ 3.668,00
IKT240X120 CCO	2400X1200			€ 3.404,00	€ 3.999,00
IKT300X100 CCO	3000X1000			€ 3.487,00	€ 3.916,00
IKT300X120 CCO	3000X1200			€ 3.783,00	€ 4.214,00
IKT360X120 CCO	3600X1200			€ 4.197,00	€ 4.609,00

(*) On request 60 mm width (CC60) cable management also available - same price
Disponibile a richiesta il tavolo con canalina larghezza 60 mm (CC60) allo stesso prezzo

TECHNICAL DETAILS / Dettagli tecnici

Item IKT300X100 CC

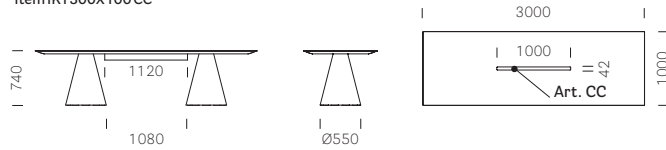

Item IKT300X100 CC60

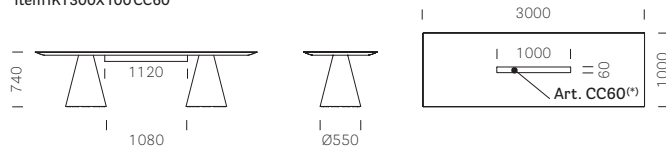

Item IKT240/300X100 CCO

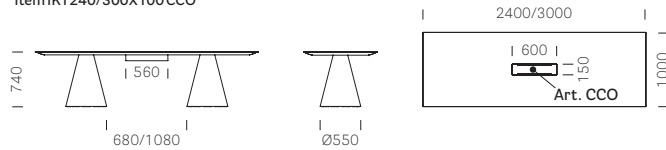

Item IKT300/360X120 CC

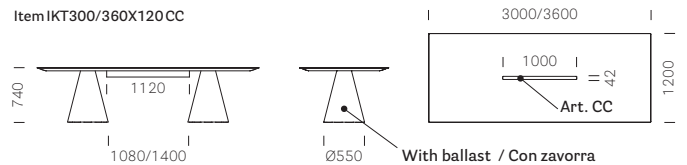

Item IKT300/360X120 CC60

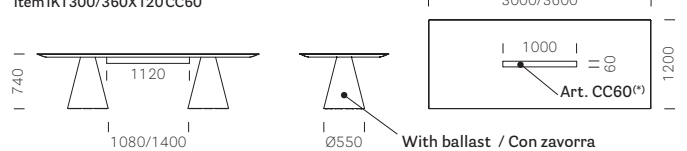

Item IKT240/300/360X120 CCO

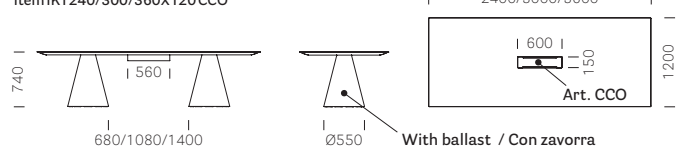

Top, frame and frame top finishes Finiture ripiano, telaio e cornice

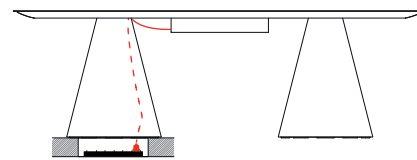
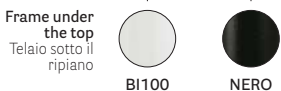
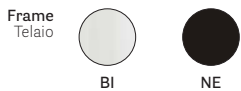

Cable routing inside the base
Passaggio cavi all'interno della base

IKON

Fixed tables / Tavoli fissi



Frame Telaio		Top Ripiano	Solid laminate top included Incluso ripiano in stratificato		
Item Articolo	Finish Finitura	Sizes Dimensioni	FNP_NE (mm 10)	CFC_BI (mm 10)	CFC_BI (mm 10)
869/2 To be filled Da zavorrare	POLYETHYLENE Polietilene	Ø 1290	€ 1.338,00	€ 1.338,00	€ 1.388,00
		Ø 1390	€ 1.473,00	€ 1.473,00	€ 1.523,00
		Ø 1490	€ 1.567,00	€ 1.567,00	€ 1.616,00
		Ø 1590	€ 1.698,00	€ 1.698,00	€ 1.748,00

TECHNICAL DETAILS / Dettagli tecnici

Item 869/2

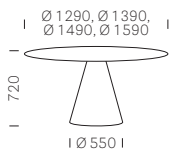

Polyethylene colours Colori polietilene

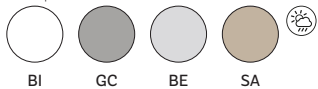

Solid laminate top finishes Finiture ripiano in stratificato



INOX

Fixed tables / Tavoli fissi



Frame Telaio		Top Ripiano	Solid laminate top included Incluso ripiano in stratificato	
Item Articolo	Finish Finitura	Sizes Dimensioni	FNP_NE (mm 10)	CFC_BI (mm 10)
4437 REG	AC	Ø 1290	€ 1.748,00	€ 1.748,00
		Ø 1390	€ 1.884,00	€ 1.884,00
		Ø 1490	€ 1.978,00	€ 1.978,00
4499 REG	AC	Ø 1290	€ 1.740,00	€ 1.740,00
		Ø 1390	€ 1.876,00	€ 1.876,00
		Ø 1490	€ 1.970,00	€ 1.970,00

TECHNICAL DETAILS / Dettagli tecnici

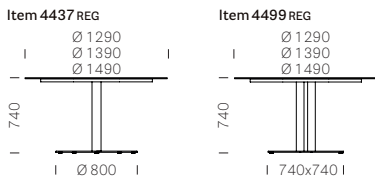

Frame finish Finitura telaio



AC

Solid laminate top finishes Finiture ripiano in stratificato



CFC_BI



FNP_NE*

*Anti-fingerprint finish
Finitura anti-impronta

INOX

Fixed tables / Tavoli fissi



Frame Telaio				Laminated top included Incluso ripiano in laminato	
Item Articolo	Sizes Dimensioni	Cross Crociera	Finish Finitura	Item Articolo	ABET 312, 386, 1813_244 (mm 50)
4401_H500	Ø400 h 500	4006	LU	D_50BA 50	€ 275,00
4402_H500	400X400 h 500		AC	D_50BA 50	€ 263,00
				_50X50BA 50	€ 292,00

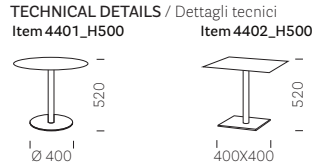

Frame finishes
Finiture telaio

AC
Brushed stainless steel
Acciaio inox satinato

LU
Polished stainless steel
Acciaio inox lucidato

Top finishes
Finiture ripiano

ABET 312, 386, 1813_244
Wenge, bleached oak, ivory laminate
Laminato color wengé, rovere sbiancato, avorio

INOX ellittico

Fixed tables / Tavoli fissi



Frame Telaio			Solid laminate top included Incluso ripiano in stratificato	
Item Articolo	Sizes Dimensioni	Finish Finitura	Item Articolo	CFC_BI (mm 10)
4901	750X500 h 730	AC	E_160X95	€ 1.354,00
			E_180X110	€ 1.716,00
4903	600X400 h 400		E_120X80	€ 894,00

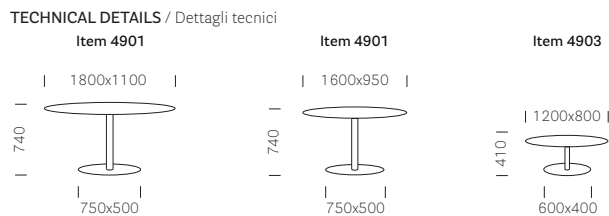

Frame finishes
Finiture telaio

AC
Brushed stainless steel
Acciaio inox satinato

Top finishes
Finiture ripiano

CFC_BI
Solid laminate in white colour
Stratificato colore bianco

INOX multifunzionale

Multifunctional table / Tavolo multifunzionale



Frame Telaio			Plywood and glass top included Incluso ripiano in multistrato e vetro	
Item Articolo	Base Base	Finish Finitura	Item Articolo	BI
4402/ACH_5904006	400x400 h590	AC	_55X55TRA	€ 459,00

TECHNICAL DETAILS / Dettagli tecnici

Item 4402/ACH_5904006

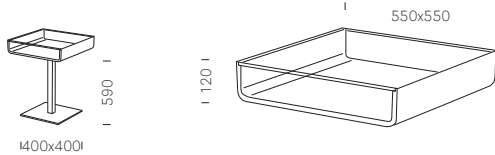



Frame finish Finitura telaio

AC
Brushed stainless steel
Acciaio inox satinato

Top finishes Finiture ripiano

BI
White lacquered oak
Rovere laccato bianco



Item Articolo	Frame Telaio	Finish Finitura	Top Ripiano	Solid laminate top included Incluso ripiano in stratificato			
				COM white bianco, black nero, 851, 526, 263 (mm 12)	COM 2810 (mm 12)	CFC_BI (mm 10)	CFP 3445, 3447 (mm 10)
TJ3		POWDER COATED / Verniciato	D_59_TJ3	€ 359,00	€ 359,00	€ 415,00	€ 415,00
			D_69_TJ3	€ 397,00	€ 397,00	€ 472,00	€ 472,00
			D_79_TJ3	€ 440,00	€ 440,00	€ 526,00	€ 526,00
		LU 	D_59_TJ3	€ 376,00	€ 376,00	€ 432,00	€ 432,00
			D_69_TJ3	€ 414,00	€ 414,00	€ 489,00	€ 489,00
			D_79_TJ3	€ 457,00	€ 457,00	€ 543,00	€ 543,00
TJ4		POWDER COATED / Verniciato	D_89_TJ4	€ 566,00	€ 566,00	€ 678,00	€ 678,00
			D_99_TJ4	€ 622,00	€ 622,00	-	-
			_59X59_TJ4	€ 435,00	€ 435,00	€ 481,00	€ 481,00
			_69X69_TJ4	€ 472,00	€ 472,00	€ 537,00	€ 537,00
			_79X79_TJ4	€ 515,00	€ 515,00	€ 596,00	€ 596,00
			119X69_TJ4	€ 619,00	€ 619,00	€ 725,00	€ 725,00
		LU 	D_89_TJ4	€ 596,00	€ 596,00	€ 708,00	€ 708,00
			D_99_TJ4	€ 652,00	€ 652,00	-	-
			_59X59_TJ4	€ 465,00	€ 465,00	€ 511,00	€ 511,00
			_69X69_TJ4	€ 502,00	€ 502,00	€ 567,00	€ 567,00
			_79X79_TJ4	€ 545,00	€ 545,00	€ 626,00	€ 626,00
			119X69_TJ4	€ 649,00	€ 649,00	€ 754,00	€ 754,00
119X79_TJ4	€ 684,00	€ 684,00	€ 805,00	€ 805,00			

TECHNICAL DETAILS / Dettagli tecnici

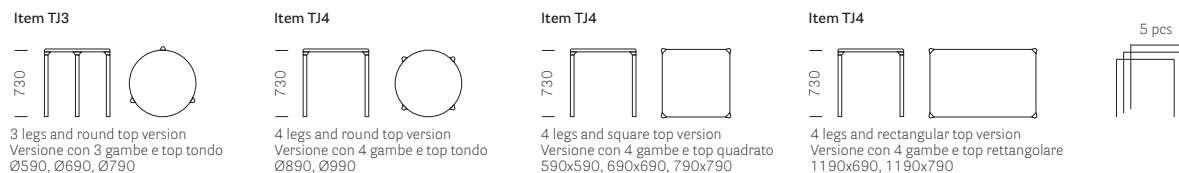

Solid laminate top
Ripiani in stratificato

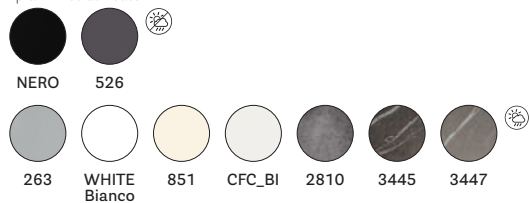

KUADRO

Fixed tables / Tavoli fissi



Item Articolo	Frame Telaio		Finish Finitura	Glass top included Incluso ripiano in vetro	
	Sizes Dimensioni			Item Articolo	SAT (mm 12)
TK_69X69	690X690		AL - AG - NERO - BI	_69X69 SAT TK	€ 515,00
			CR	_69X69 SAT TK	€ 588,00
			ST	_69X69 SAT TK	€ 636,00
TK_80X80	800X800		AL - AG - NERO - BI	_80X80 SAT TK	€ 575,00
			CR	_80X80 SAT TK	€ 656,00
			ST	_80X80 SAT TK	€ 704,00
TK_90X90	900X900		AL - AG - NERO - BI	_90X90 SAT TK	€ 653,00
			CR	_90X90 SAT TK	€ 741,00
			ST	_90X90 SAT TK	€ 790,00
TK_120X120	1200X1200		AL - AG - NERO - BI	120X120 SAT TK	€ 927,00
			CR	120X120 SAT TK	€ 1.052,00
			ST	120X120 SAT TK	€ 1.113,00
TK_120X69	1200X690		AL - AG - NERO - BI	120X69 SAT TK	€ 669,00
			CR	120X69 SAT TK	€ 752,00
			ST	120X69 SAT TK	€ 806,00
TK_140X80	1400X800		AL - AG - NERO - BI	140X80 SAT TK	€ 765,00
			CR	140X80 SAT TK	€ 860,00
			ST	140X80 SAT TK	€ 917,00
TK_180X90	1800X900		AL - AG - NERO - BI	180X90 SAT TK	€ 969,00
			CR	180X90 SAT TK	€ 1.103,00
			ST	180X90 SAT TK	€ 1.163,00

TECHNICAL DETAILS / Dettagli tecnici

Item TK_69X69

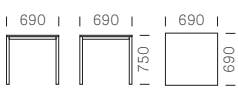

Item TK_80X80

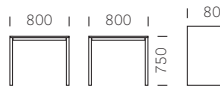

Item TK_90X90

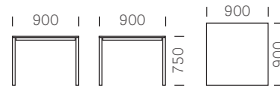

Item TK_120X120

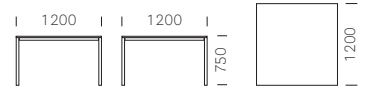

Item TK_120X69

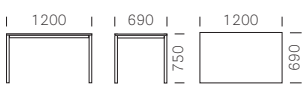

Item TK_140X80

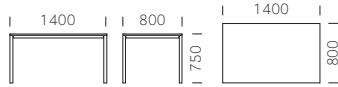

Item TK_180X90

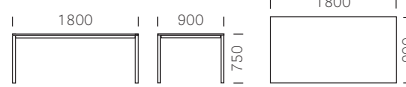

Frame finishes

Finiture telaio

CR
Chromed steel
Acciaio cromato

ST
Brushed steel
Acciaio satinato

AL, AG, NERO, BI
Silver, textured silver, black and white powder coated
Acciaio verniciato alluminio, alluminio goffrato, nero e bianco

Top finish

Finitura ripiano

SAT
Frosted glass
Vetro acidato

KUADRO

Fixed tables / Tavoli fissi



Item Articolo	Frame Telaio		Top Ripiano Item Articolo	Laminated top included Incluso ripiano in laminato		Solid laminate top included Incluso ripiano in stratificato	
	Sizes Dimensioni	Finish Finitura		ABET 312, 386, 421, 1813_244, 406_0020 (mm 20)	BA/20FN 0720, 0718 (mm 20)	CFP_BI (mm 10)	COP white bianco/black nero /851/526 (mm 12)
TK2_69X69	690X690	VER	_69X69	€ 289,00	€ 320,00	€ 455,00	€ 358,00
		CR		€ 362,00	€ 393,00	€ 528,00	€ 431,00
		ST		€ 410,00	€ 441,00	€ 576,00	€ 479,00
TK2_79X79	790X790	VER	_79X79	€ 314,00	€ 345,00	€ 509,00	€ 398,00
		CR		€ 394,00	€ 426,00	€ 589,00	€ 479,00
		ST		€ 442,00	€ 474,00	€ 637,00	€ 527,00
TK2_89X89	890X890	VER	_89X89	€ 340,00	€ 389,00	€ 597,00	€ 474,00
		CR		€ 428,00	€ 478,00	€ 686,00	€ 562,00
		ST		€ 476,00	€ 526,00	€ 734,00	€ 610,00
TK2_119X119	1190X1190	VER	119X119	€ 489,00	€ 619,00	€ 1.082,00	€ 809,00
		CR		€ 614,00	€ 744,00	€ 1.207,00	€ 934,00
		ST		€ 675,00	€ 805,00	€ 1.268,00	€ 995,00
TK2_119X69	1190X690	VER	119X69	€ 376,00	€ 426,00	€ 676,00	€ 526,00
		CR		€ 459,00	€ 509,00	€ 760,00	€ 609,00
		ST		€ 514,00	€ 563,00	€ 814,00	€ 663,00
TK2_119X79	1190X790	VER	119X79	€ 376,00	€ 426,00	€ 676,00	€ 526,00
		CR		€ 459,00	€ 509,00	€ 760,00	€ 609,00
		ST		€ 514,00	€ 563,00	€ 814,00	€ 663,00
TK2_139X79	1390X790	VER	139X79	€ 405,00	€ 506,00	€ 792,00	€ 572,00
		CR		€ 500,00	€ 601,00	€ 887,00	€ 667,00
		ST		€ 557,00	€ 658,00	€ 944,00	€ 725,00
TK2_179X89	1790X890	VER	179X89	€ 519,00	€ 669,00	€ 1.033,00	€ 868,00
		CR		€ 653,00	€ 803,00	€ 1.167,00	€ 1.001,00
		ST		€ 713,00	€ 862,00	€ 1.226,00	€ 1.061,00

TECHNICAL DETAILS / Dettagli tecnici

Item TK2_69X69

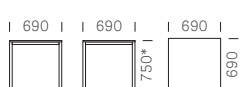

Item TK2_89X89



Item TK2_119X69

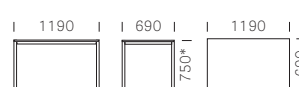

Item TK2_139X79

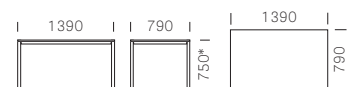

Item TK2_79X79

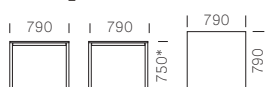

Item TK2_119X119



Item TK2_119X79



Item TK2_179X89

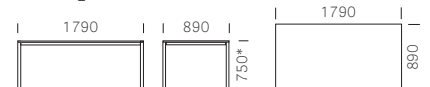

* Height of the table decreases if combined with a solid laminate top
L'altezza del tavolo diminuisce quando abbinato a un ripiano in stratificato

Frame finishes
Finiture telaio

CR
Chromed steel
Acciaio cromato

ST
Brushed steel
Acciaio satinato

VER
Powder coated steel for indoor use, see colours at page 282
Acciaio verniciato per interno, vedere colori a pagina 282

Top finish
Finitura ripiano

ABET 312, 386, 421, 1813_244, 406_0020
Wenge, bleached oak, black, ivory and white laminate
Laminato color wengé, rovere sbiancato, nero, avorio e bianco

FENIX 0720, 0718
Black, grey laminate
Laminato color nero, grigio

KUADRO desk

Fixed tables / Tavoli fissi



Item Articolo	Frame Telaio	Finish Finitura	Top Ripiano	Laminated top included Incluso ripiano in laminato	
	Sizes Dimensioni		Item Articolo	ABET 406_0020, 527 (mm 20)	Fittings Accessori
TK2S179X140	1790X1400	VER	179X140 BA 20	€ 894,00	-
DSP Panel only (1 pc) Solo pannello (1 pz)	1500X440h	C210÷C217	-	-	€ 367,00
		D40÷D44			€ 463,00
		G*			€ 584,00
		H60÷H61			€ 411,00
DSP/2 Panel only (1 pc) Solo pannello (1 pz)	1500X600h	H120÷H127	-	-	€ 383,00
		C210÷C217			€ 480,00
		D40÷D44			€ 601,00
		G*			€ 428,00
TK2S340X140	3400X1400	H60÷H61	-	-	€ 734,00
		H120÷H127			€ 926,00
		C210÷C217			€ 1.168,00
		D40÷D44			€ 822,00
DSP Panel only (2 pcs) Solo pannello (2pz)	1500X440h	G*	-	-	€ 766,00
		H60÷H61			€ 960,00
		H120÷H127			€ 1.202,00
		C210÷C217			€ 856,00
DSP/2 Panel only (2 pcs) Solo pannello (2pz)	1500X600h	D40÷D44	-	-	€ 766,00
		G*			€ 960,00
		H60÷H61			€ 1.202,00
		H120÷H127			€ 856,00

*Excluding / Escluso G220+G225, G230+G239

TECHNICAL DETAILS / Dettagli tecnici

Item TK2S179X140

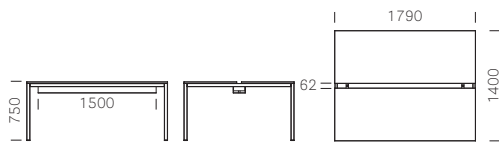

Item TK2S340X140

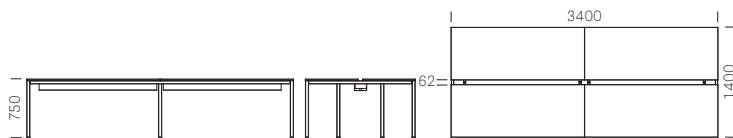

Frame finishes Finiture telaio

VER
Powder coated steel for indoor use, see colours at page 282
Acciaio verniciato per interno, vedere colori a pagina 282

Top finish Finitura ripiano

ABET 406_0020, 527
White, light grey laminate
Laminato color bianco, grigio chiaro

Accessori - Fittings

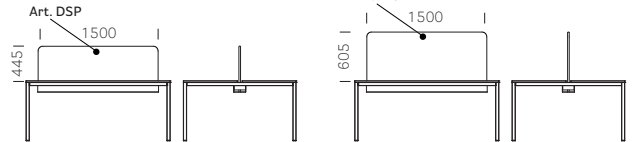

Accessori - Fittings

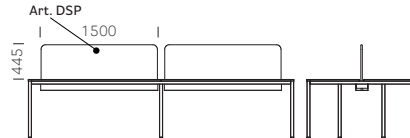

Art. DSP/2

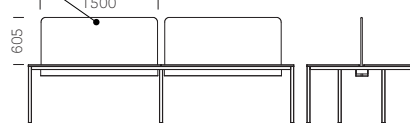

For fabrics see page 284
Per i tessuti si veda p. 284

MAGIC

Extensible tables / Tavoli allungabili



Frame Telaio			Glass top included Incluso ripiano in vetro		
Item Articolo	Sizes Dimensioni	Finish Finitura	Item Articolo	TRA (mm 12)	SAT (mm 12)
TM_160X90	1600X900 → 2400X900	AC	160X90 TRA TS	€ 2.281,00	-
TM_200X90	2000X900 → 2800X900		200X90 TRA TS	€ 2.446,00	-
			200X90 SAT TS	-	€ 2.545,00

TECHNICAL DETAILS / Dettagli tecnici

Item TM_160X90

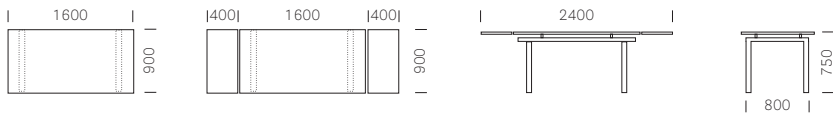

Item TM_200X90

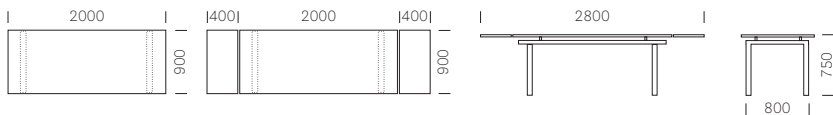

Frame finishes

Finiture telaio
AC
Brushed stainless steel
Acciaio inox satinato

Top finishes

Finiture ripiano
SAT
Frosted glass
Vetro acidato

TRA
Clear glass
Vetro trasparente

MALMÖ

Fixed and extensible tables / Tavoli fissi e allungabili



Frame Telaio			Solid laminate top included Incluso ripiano in stratificato		
Item Articolo	Sizes Dimensioni	Finish Finitura	Item Articolo	CFP_BI (mm 12)	COP_NERO (mm 12)
TMLF_90X90	900X900	FR	90X90	€ 1.225,00	-
		AN		-	€ 1.102,00
TMLF_140X90	1400X900	FR	140X90	€ 1.571,00	-
		AN		-	€ 1.282,00
TMLF_180X90	1800X900	FR	180X90	€ 2.129,00	-
		AN		-	€ 1.659,00

TECHNICAL DETAILS / Dettagli tecnici

Item TMLF_90X90

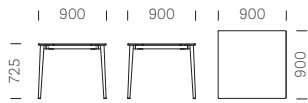

Item TMLF_140X90

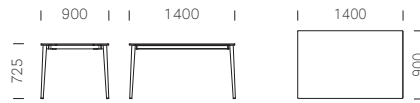

Item TMLF_180X90

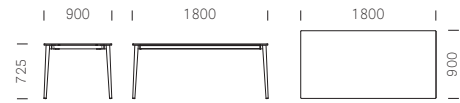

Frame Telaio			Veneered top included Incluso ripiano in impiallacciato		Solid laminate top included Incluso ripiano in stratificato	
Item Articolo	Sizes Dimensioni	Finish Finitura	FR (mm 14)	AN (mm 14)	CFP_BI (mm 12)	
TML_190X90	1900X900 → 2900X900	FR	€ 2.933,00	-	€ 2.886,00	
		AN	-	€ 2.933,00	-	

TECHNICAL DETAILS / Dettagli tecnici

Item TML_190X90

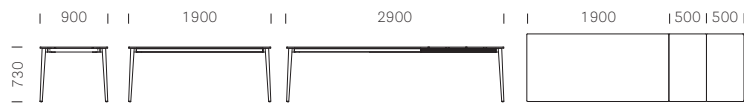

Frame finishes

Finiture telaio

AN
Black lacquered ash
Frassino laccato nero

FR
Bleached ash
Frassino sbiancato

Top finishes

Finiture ripiano

CFP_BI
Solid laminate in white colour
Stratificato colore bianco

COP_NERO
Solid laminate in black colour
Stratificato colore nero



Item Articolo	Frame Telaio Sizes Dimensioni	Finish Finitura	Veneered top included Incluso ripiano in impiallacciato	Solid laminate top included Incluso ripiano in stratificato			MDF lacquered top included Incluso ripiano in MDF laccato
			FR/AN (mm 22)	CFP_BI (mm 12)	COP_NERO (mm 12)	FPN_NE (mm 10)	RAL3018/RAL1019 (mm 22)
MLTD_60X36	Ø 600X360h	FR/AN	€ 644,00	-	-	-	€ 565,00
		FR	-	€ 427,00	-	-	-
		AN	-	-	€ 346,00	€ 509,00	-
MLTD_60X48	Ø 600X480h	FR/AN	€ 644,00	-	-	-	€ 565,00
		FR	-	€ 427,00	-	-	-
		AN	-	-	€ 346,00	€ 509,00	-
MLT_50X50X36	500X500X360h	FR/AN	€ 649,00	-	-	-	€ 574,00
		FR	-	€ 511,00	-	-	-
		AN	-	-	€ 424,00	€ 582,00	-
MLT_50X50X48	500X500X480h	FR/AN	€ 649,00	-	-	-	€ 574,00
		FR	-	€ 511,00	-	-	-
		AN	-	-	€ 424,00	€ 582,00	-
MLT_60X60X36	600X600X360h	FR/AN	€ 714,00	-	-	-	€ 631,00
		FR	-	€ 511,00	-	-	-
		AN	-	-	€ 424,00	€ 582,00	-
MLT_60X60X48	600X600X480h	FR/AN	€ 714,00	-	-	-	€ 631,00
		FR	-	€ 511,00	-	-	-
		AN	-	-	€ 424,00	€ 582,00	-
MLTD100X36	Ø 1000X360h	FR/AN	€ 1.124,00	-	-	-	€ 905,00
		FR	-	€ 905,00	-	-	-
MLT120X74X36	1200X740X360h	FR/AN	€ 1.073,00	-	-	-	-
		AN	-	-	-	€ 819,00	-

TECHNICAL DETAILS / Dettagli tecnici

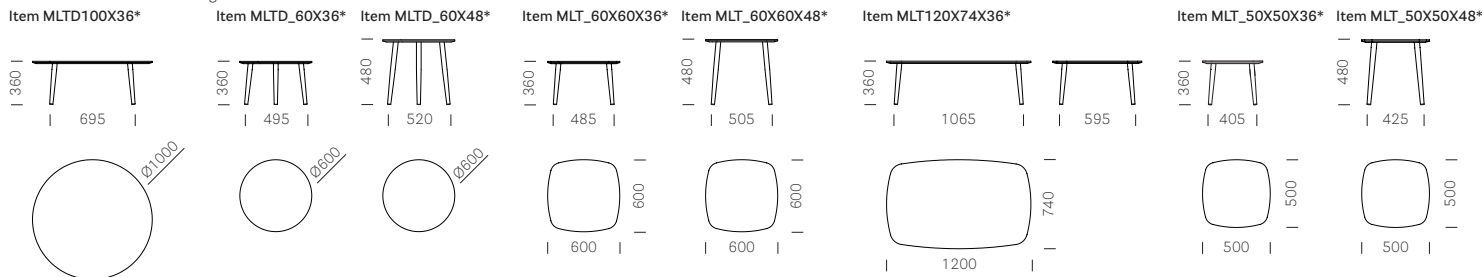

* Table height decreases of 1 cm for solid laminate top versions / L'altezza del tavolo si riduce di 1 cm per le versioni con ripiano in stratificato

MDF lacquered top finishes
Finiture ripiano MDF



Solid laminate top finishes
Finiture ripiano in stratificato



*Anti-fingerprint finish
Finitura anti-impronta

Veneered top finishes
Finiture ripiano in impiallacciato

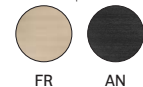

Frame finishes
Finiture telaio



MALMÖ marble

Coffee tables / Tavolini



Item Articolo	Sizes Dimensioni	Finish Finitura	Marble top included Incluso ripiano in marmo			
			MBC (mm 20)	MED (mm 20)	MGC (mm 20)	MVG (mm 20)
MLTD_60X36	Ø 600X360h	FR	€ 936,00	-	-	-
		AN	-	€ 936,00	€ 936,00	€ 936,00
MLTD_60X48	Ø 600X480h	FR	€ 936,00	-	-	-
		AN	-	€ 936,00	€ 936,00	€ 936,00
MLTD_70X36	Ø 700X360h	FR	€ 1.135,00	-	-	-
		AN	-	€ 1.135,00	€ 1.135,00	€ 1.135,00
MLTD_70X48	Ø 700X480h	FR	€ 1.135,00	-	-	-
		AN	-	€ 1.135,00	€ 1.135,00	€ 1.135,00
MLT_50X50X36	500X500X360h	FR	€ 974,00	-	-	-
		AN	-	€ 974,00	€ 974,00	€ 974,00
MLT_50X50X48	500X500X480h	FR	€ 974,00	-	-	-
		AN	-	€ 974,00	€ 974,00	€ 974,00
MLT_60X60X36	600X600X360h	FR	€ 1.007,00	-	-	-
		AN	-	€ 1.007,00	€ 1.007,00	€ 1.007,00
MLT_60X60X48	600X600X480h	FR	€ 1.007,00	-	-	-
		AN	-	€ 1.007,00	€ 1.007,00	€ 1.007,00

TECHNICAL DETAILS / Dettagli tecnici

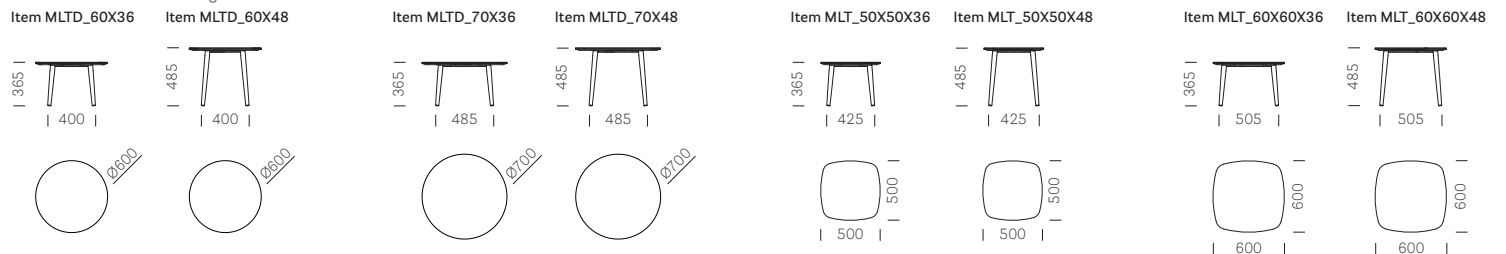

Marble top finishes
Finiture ripiano in marmo

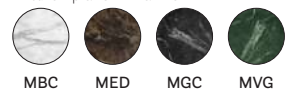

Frame finishes
Finiture telaio



Matt smoothed
Levigato opaco

MATRIX

Extensible tables / Tavoli allungabili



Item Articolo	Frame Telaio Sizes Dimensioni	Finish Finitura	Glass top included Incluso ripiano in vetro		Laminated top included Incluso ripiano in laminato
			NER (mm 12)	BIA (mm 12)	ABET 312, 406_0020 (mm 20)
TMA_88X86	880X860 → 1380X860	AA	-	-	€ 1.620,00
		BI	-	-	€ 1.700,00
TMA_130X86	1300X860 → 2100X860	AA	€ 2.236,00	€ 2.369,00	€ 1.926,00
		NERO	€ 2.316,00	-	-
		BI	-	€ 2.448,00	€ 2.005,00
TMA_165X86	1650X860 → 2650X860	AA	€ 2.468,00	€ 2.633,00	€ 2.091,00
		NERO	€ 2.547,00	-	-
		BI	-	€ 2.712,00	€ 2.170,00

TECHNICAL DETAILS / Dettagli tecnici

Item TMA_88X86



Item TMA_130X86



Item TMA_165X86

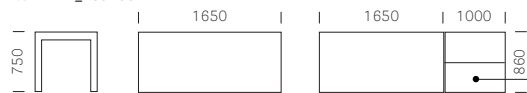

Folding extension finish: laminate (for laminate top) or silver lacquered MDF (for glass top)
Finitura allunga: laminato (per ripiano in laminato) o MDF laccato argento (per ripiano in vetro)

Frame finishes Finiture telaio

AA
Anodized aluminium
Alluminio anodizzato

BI
White powder coated
Verniciato bianco

NERO
Black powder coated
Verniciato nero

Top finishes Finiture ripiano

NER
Black lacquered glass
Vetro laccato nero

BIA
White lacquered extra-clear glass
Vetro extra-light laccato bianco

ABET 312, 406_0020
Wenge, white laminate
Laminato color wengé, bianco

MATRIX

Fixed tables / Tavoli fissi



Frame Telaio			Glass top included Incluso ripiano in vetro	
Item Articolo	Sizes Dimensioni	Finish Finitura	NER (mm 12)	BIA (mm 12)
TMF_86X86	860X860	NERO	€ 1.378,00	-
TMF_86X86	860X860	BI	-	€ 1.479,00
TMF_200X86	2000X860	NERO	€ 1.915,00	-

TECHNICAL DETAILS / Dettagli tecnici

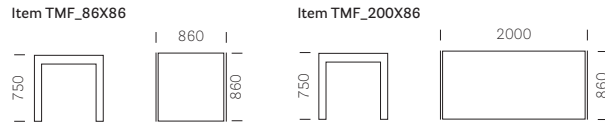

MATRIX consolle

Extensible tables / Tavoli allungabili



Frame Telaio			Glass top included Incluso ripiano in vetro
Item Articolo	Sizes Dimensioni	Finish Finitura	NER (mm 12)
TMC_160X50	1600X500 → 1600X875	NERO	€ 2.248,00

TECHNICAL DETAILS / Dettagli tecnici

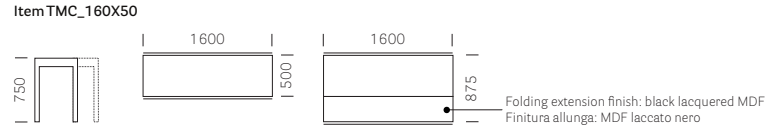

MATRIX outdoor

Fixed tables / Tavoli fissi



Frame Telaio			Solid laminate top included Incluso ripiano in stratificato
Item Articolo	Sizes Dimensioni	Finish Finitura	CFC_BI (mm 10)
TMD_200X86	2000X860	AA	€ 2.214,00

TECHNICAL DETAILS / Dettagli tecnici

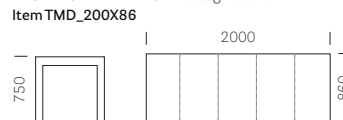

Frame finishes
Finiture telaio

AA
Anodized aluminium
Alluminio anodizzato

BI
White powder coated
Verniciato bianco

NERO
Black powder coated
Verniciato nero

Top finishes
Finiture ripiano

NER
Black lacquered glass
Vetro laccato nero

BIA
White lacquered extra-clear glass
Vetro extra-light laccato bianco

CFC_BI
Solid laminate in white colour
Stratificato colore bianco

MATRIX desk

Fixed tables / Tavoli fissi



Item Articolo	Frame Telaio	Finish Finitura	Laminated top included Incluso ripiano in laminato	
	Sizes Dimensioni		ABET 312, 406_0020, 527 (mm 20)	Fittings Accessori
TMS_200X160	2000X1600	AA	€ 1.966,00	-
TMS_350X160	3500X1600		€ 2.727,00	-
CC/DSP Cable management only (1 pc) Solo canalina (1 pz)	1500X150X120h	BIANCO	-	€ 164,00
DSP Panel only (1 pc) Solo pannello (1 pz)	1500X440h	C210+C217	-	€ 367,00
		D40+D44		€ 463,00
		G*		€ 584,00
DSP/2 Panel only (1 pc) Solo pannello (1 pz)	1500X600h	H60+H61	-	€ 411,00
		H120+H127		€ 383,00
		C210+C217		€ 480,00
DSP/2 Panel only (1 pc) Solo pannello (1 pz)	1500X600h	D40+D44	-	€ 601,00
		G*		€ 428,00
		H60+H61		
		H120+H127		

*Excluding / Escluso G220+G225, G230+G239

TECHNICAL DETAILS / Dettagli tecnici

Item TMS_200X160

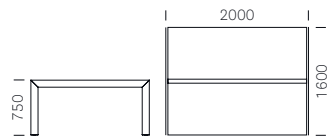

Accessori - Fittings

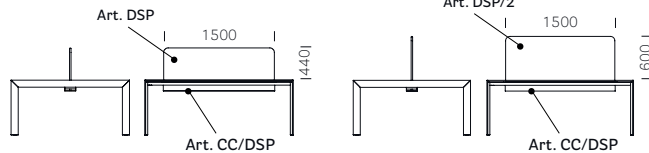

Item TMS_350X160



Accessori - Fittings

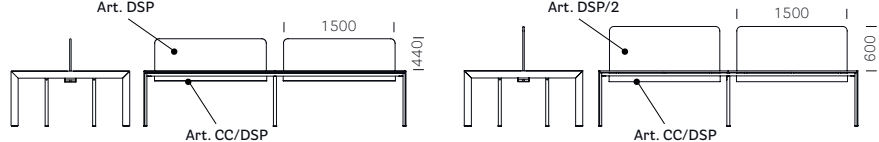

Frame finishes Finiture telaio

AA
Anodized aluminium
Alluminio anodizzato

Top finishes Finiture ripiano

ABET 312, 406_0020, 527
Wenge, white, light grey laminate
Laminato color wengé, bianco, grigio chiaro

For fabrics see page 284
Per i tessuti si veda p. 284

MORE

Extensible tables / Tavoli allungabili



Frame Telaio			Melamine top included Incluso ripiano in nobilitato
Item Articolo	Sizes Dimensioni	Finish Finitura	BIANCO White (mm 16)
TMO_110X75	1100 → 1600 (X750)	BI	€ 1.243,00
TMO_140X85	1400 → 1900 → 2400 (X850)		€ 1.494,00
TMO_180X85	1800 → 2300 → 2800 (X850)		€ 1.616,00

TECHNICAL DETAILS / Dettagli tecnici

Item TMO_110X75

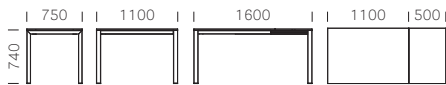

Item TMO_140X85

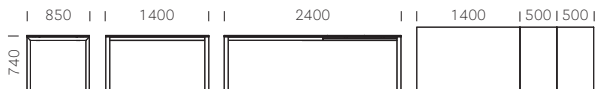

Item TMO_180X85

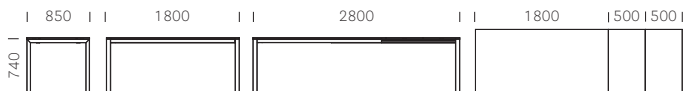

Frame finishes

Finiture telaio

BI
White powder coated
Verniciato bianco

Top finish

Finitura ripiano

BIANCO White
Melamine in white colour
Nobilitato colore bianco

PARENTHESIS

Coffee tables / Tavolini



Item Articolo	Frame Telaio		Top Ripiano Item Articolo	Solid laminate top included Incluso ripiano in stratificato		
	Sizes Dimensioni	Finish Finitura		CFP_BI (mm 10)	FNP_NE (mm 10) Anti-fingerprint finish Finitura anti-impronta	COP_234 (mm 6)
P10001	Ø 425X450h	RS/BI	D_40_CFP_BI	€ 656,00	-	-
		AN	D_40_FNP_NERO	-	€ 656,00	-
		GC	D_40_COP_234	-	-	€ 675,00
P10002	Ø 425X640h	RS/BI	D_40_CFP_BI	€ 715,00	-	-
		AN	D_40_FNP_NERO	-	€ 715,00	-
		GC	D_40_COP_234	-	-	€ 735,00
P10005	Ø 730X300h	RS/BI	D_70_CFP_BI	€ 710,00	-	-
		AN	D_70_FNP_NERO	-	€ 710,00	-
		GC	D_70_COP_234	-	-	€ 619,00
P10006	1200X300h	RS/BI	0117X70_CFP_BI	€ 770,00	-	-
		AN	0117X70_FNP_NERO	-	€ 770,00	-
		GC	0117X70_COP_234	-	-	€ 809,00

TECHNICAL DETAILS / Dettagli tecnici

Item P10001

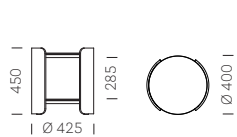

Item P10002

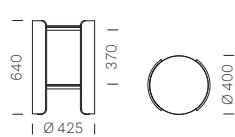

Item P10005

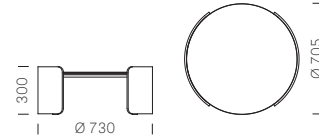

Item P10006

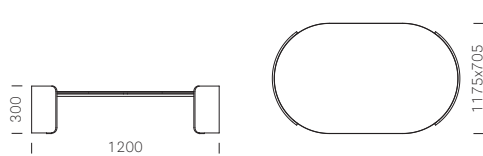

Solid laminate top finishes
Finiture ripiano in stratificato



Frame finishes
Finiture telaio



PARENTHESIS marble

Coffee tables / Tavolini



Item Articolo	Frame Telaio		Top Ripiano	Marble top included Incluso ripiano in marmo			
	Sizes Dimensioni	Finish Finitura		MBC (mm 20)	MED (mm 20)	MGC (mm 20)	MVG (mm 20)
P10001	Ø 425X450h	RS	D_40	€ 977,00	-	-	-
		AN		-	€ 977,00	€ 977,00	€ 977,00
P10002	Ø 425X640h	RS	D_40	€ 1.037,00	-	-	-
		AN		-	€ 1.037,00	€ 1.037,00	€ 1.037,00
P10005	Ø 730X300h	RS	D_70	€ 946,00	-	-	-
		AN		-	€ 946,00	€ 946,00	€ 946,00
P10006	1200X300h	RS	0117X70	€ 1.432,00	-	-	-
		AN		-	€ 1.432,00	€ 1.432,00	€ 1.432,00

TECHNICAL DETAILS / Dettagli tecnici

Item P10001

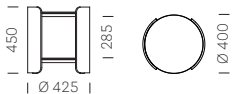

Item P10002

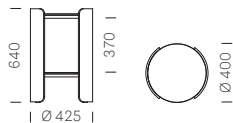

Item P10005

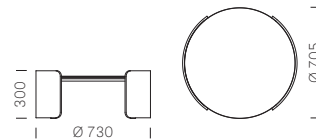

Item P10006

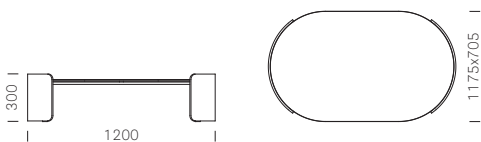

Marble top finishes Finiture ripiano in marmo



Frame finishes Finiture telaio



Matt smoothed
Levigato opaco

PLANO

Fixed tables / Tavoli fissi



Frame
Telaio

Solid laminate top included
Incluso ripiano in stratificato

Item Articolo	Sizes Dimensioni	Table bases Basamenti	Cross Crociera	Finish Finitura	Cable management Canalina	CFC_BI (mm 10)	COI 263, Bianco White (mm 12)			
PLO_240X120CC	2400X1200	N.2. ART.4431 REG	4016	AC	With cable management Con canalina	€ 2.684,00	€ 2.194,00			
PLO_240X140CC	2400X1400					€ 2.922,00	€ 2.363,00			
PLO_300X120CC	3000X1200					€ 3.299,00	€ 2.664,00			
PLO_300X140CC	3000X1400					€ 3.581,00	€ 2.937,00			
PLO_360X120CC	3600X1200					€ 3.963,00	€ 3.271,00			
PLO_360X140CC	3600X1400					€ 4.389,00	€ 3.496,00			
PLO_240X120	2400X1200				N.2. ART.4431 REG	4016	AC	Without cable management Senza canalina	€ 2.435,00	€ 1.944,00
PLO_240X140	2400X1400								€ 2.673,00	€ 2.113,00
PLO_300X120	3000X1200								€ 2.841,00	€ 2.207,00
PLO_300X140	3000X1400								€ 3.123,00	€ 2.480,00
PLO_360X120	3600X1200								€ 3.331,00	€ 2.641,00
PLO_360X140	3600X1400								€ 3.757,00	€ 2.866,00
PLR_240X120CC	2400X1200	N.2. ART.4491	4016	AC	With cable management Con canalina	€ 2.772,00	€ 2.282,00			
PLR_240X140CC	2400X1400					€ 3.010,00	€ 2.451,00			
PLR_300X120CC	3000X1200					€ 3.387,00	€ 2.753,00			
PLR_300X140CC	3000X1400					€ 3.669,00	€ 3.026,00			
PLR_360X120CC	3600X1200					€ 4.051,00	€ 3.360,00			
PLR_360X140CC	3600X1400					€ 4.478,00	€ 3.585,00			
PLR_240X120	2400X1200				N.2. ART.4491	4016	AC	Without cable management Senza canalina	€ 2.524,00	€ 2.032,00
PLR_240X140	2400X1400								€ 2.762,00	€ 2.201,00
PLR_300X120	3000X1200								€ 2.929,00	€ 2.295,00
PLR_300X140	3000X1400								€ 3.211,00	€ 2.568,00
PLR_360X120	3600X1200								€ 3.419,00	€ 2.729,00
PLR_360X140	3600X1400								€ 3.846,00	€ 2.954,00

TECHNICAL DETAILS / Dettagli tecnici

Rectangular top version / Versione con ripiano rettangolare (PLR)

Oval top version / Versione con ripiano ovale (PLO)

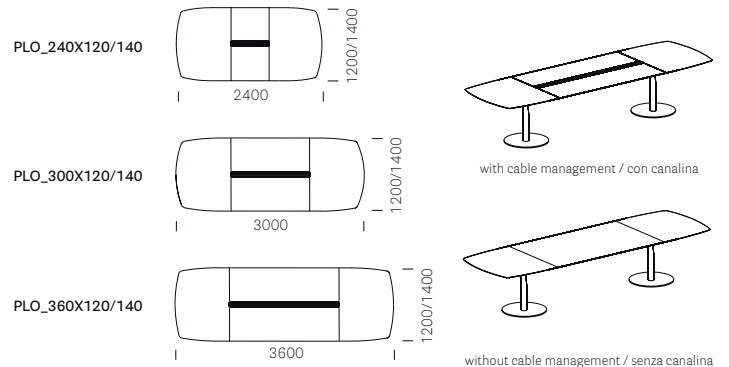
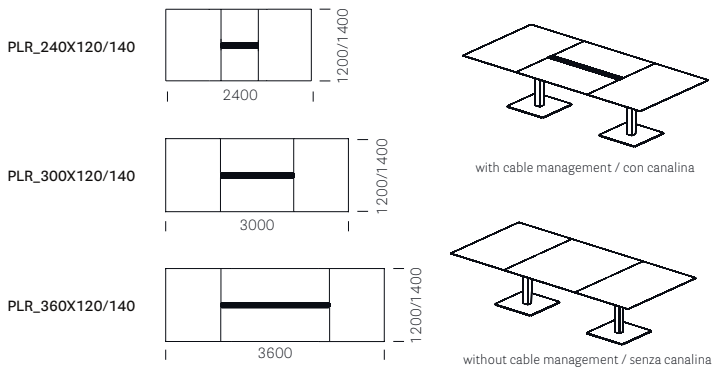

Frame finishes
Finiture telaio

AC
Brushed stainless steel
Acciaio inox satinato

Top finishes
Finiture ripiano

CFC_BI
Solid laminate in white colour
Stratificato colore bianco

COI 263, Bianco White
Grey, white solid laminate
Stratificato colore grigio, bianco

PLANO2

Fixed tables / Tavoli fissi



Item Articolo	Sizes Dimensioni	Frame Telaio			Solid laminate top included Incluso ripiano in stratificato	
		Table bases Basamenti	Cross Crociera	Finish Finitura	Cable management Canalina	CFC_BI (mm 6)
PL2_240X120 CC	2400X1200	N.2. ART.4490	SPEC	BI	With cable management Con canalina 42 mm (CC)	€ 2.682,00
PL2_300X120 CC	3000X1200					€ 2.873,00
PL2_360X120 CC	3600X1200					€ 3.360,00
PL2_240X120	2400X1200				Without cable management Senza canalina	€ 2.350,00
PL2_300X120	3000X1200					€ 2.541,00
PL2_360X120	3600X1200					€ 3.027,00
PL2_240X120 CC	2400X1200	N.2. ART.4491	SPEC	AC	With cable management Con canalina 42 mm (CC)	€ 2.847,00
PL2_300X120 CC	3000X1200					€ 3.039,00
PL2_360X120 CC	3600X1200					€ 3.525,00
PL2_240X120	2400X1200				Without cable management Senza canalina	€ 2.515,00
PL2_300X120	3000X1200					€ 2.706,00
PL2_360X120	3600X1200					€ 3.192,00

(*) On request 60 mm width (CC60) cable management also available - same price
Disponibile a richiesta il tavolo con canalina larghezza 60 mm (CC60) allo stesso prezzo

TECHNICAL DETAILS / Dettagli tecnici

With cable management / Con canalina

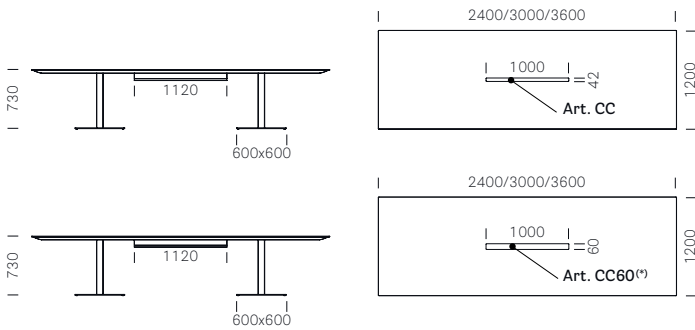

Without cable management / Senza canalina

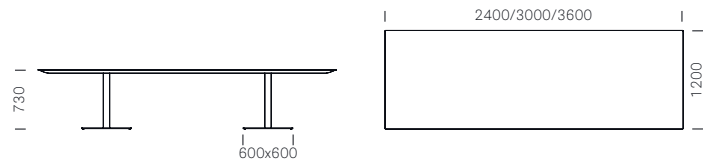

Frame finishes

Finiture telaio

AC
Brushed stainless steel
Acciaio inox satinato

BI
White powder coated
Verniciato bianco

Top finish

Finitura ripiano

CFC_BI
Solid laminate in white colour
Stratificato colore bianco

SERIF



Fixed tables / Tavoli fissi

VAT NOT INCLUDED / Iva esclusa

Tables / Tavoli



Item Articolo	Sizes Dimensioni	Finish Finitura	Solid laminate top included Incluso ripiano in stratificato	
			CFC_BI (mm 10)	COL_263 (mm 12)
861	690X690X1000	BI	€ 511,00	-
		GC	-	€ 474,00

TECHNICAL DETAILS / Dettagli tecnici

Item 861

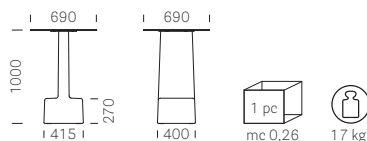

Polyethylene colours
Colori polietilene

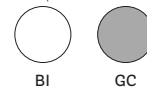

Solid laminate colours
Colori stratificato

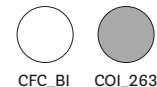

SNOW



Fixed tables / Tavoli fissi



Item Articolo	Sizes Dimensioni	Finish Finitura	Polypropylene top included Incluso ripiano in polipropilene	
			BI	
301	800X800X745	BI	€ 211,00	

TECHNICAL DETAILS / Dettagli tecnici

Item 301

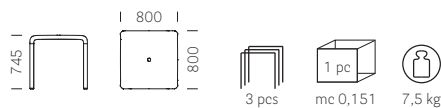

Polypropylene colours
Colori polipropilene



Aluminium finishes
Finiture alluminio



SNOW junior



Fixed tables / Tavoli fissi



Item Articolo	Sizes Dimensioni	Finish Finitura	Polypropylene top included Incluso ripiano in polipropilene	
			BI	
301 JR	800X800X580	BI	€ 211,00	

TECHNICAL DETAILS / Dettagli tecnici

Item 301 JR

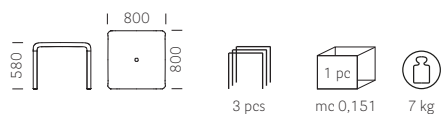

Polypropylene colours
Colori polipropilene



Aluminium finishes
Finiture alluminio



SIDE-TABLE

Coffee tables / Tavolini



Frame (mm Ø16) Telaio			Methacrylate top included Incluso ripiano in metacrilato
Item Articolo	Base Base	Finish Finitura	White Bianco (mm 6)
5900	460X455	BI100	€ 244,00

TECHNICAL DETAILS / Dettagli tecnici
Item 5900Frame finish
Finitura telaio

BI100
White powder coated
Acciaio verniciato bianco

Top finishes
Finiture ripiano

White Bianco
Methacrylate in white colour
Metacrilato colore bianco



Frame Telaio			Solid laminate top included Incluso ripiano in stratificato
Item Articolo	Base Base	Finish Finitura	CFP_BI, FNP_NE (mm 10)
TST_45X45	450X450	VER	€ 260,00
		ST	€ 338,00

TECHNICAL DETAILS / Dettagli tecnici
Item TST_45X45Frame finish
Finitura telaio

ST
Brushed steel
Acciaio satinato

VER
Powder coated steel for indoor use, see colours at page 282
Acciaio verniciato per interno, vedere colori a pagina 282

Top finishes
Finiture ripiano

CFP_BI
Solid laminate in white colour
Stratificato colore bianco

FNP_NE
Solid laminate in black colour
Stratificato colore nero

SPACE

Fixed tables / Tavoli fissi



Frame Telaio		Top Ripiano	Glass top included Incluso ripiano in vetro		Laminated top included Incluso ripiano in laminato	
Item Articolo	Sizes Dimensioni	Finish Finitura	Item Articolo	TRA (mm 12)	SAT (mm 12)	ABET 312, 386, 406_0020 (mm 30)
TS_160X90	1600X900	AC	160X90 TRA TS	€ 1.455,00	-	-
			160X90 BA 30	-	-	€ 1.356,00
200X90 TRA TS	€ 1.620,00		-	-		
200X90 SAT TS	-		€ 1.670,00	-		
TS_200X90	2000X900	200X90 BA 30	-	-	-	€ 1.480,00

TECHNICAL DETAILS / Dettagli tecnici

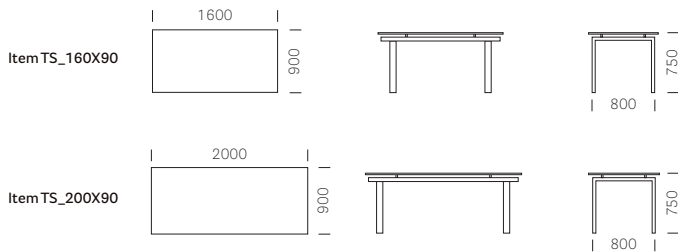

Frame finishes Finiture telaio

AC
Brushed stainless steel
Acciaio inox satinato

Top finishes Finiture ripiano

SAT
Frosted glass
Vetro acidato

TRA
Clear glass
Vetro trasparente

ABET 312, 386, 406_0020
Wenge, bleached oak and white laminate
Laminato color wengé, rovere sbiancato e bianco

SURFACE

Extensible tables / Tavoli allungabili



Frame Telaio			Top included Incluso ripiano
Item Articolo	Sizes Dimensioni	Finish Finitura	RS - W - BI
TSU2_188X90	1880 → 2380 → 2880 (X900)	RS - W - BI	€ 3.222,00

TECHNICAL DETAILS / Dettagli tecnici

Item TSU2_188X90

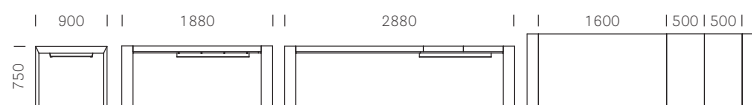

Finishes Finiture

RS
Bleached oak
Rovere sbiancato

W
Wenge stained oak
Rovere tinto wengé

BI
White matt lacquered
Laccato bianco goffrato

TOA desk

Fixed tables / Tavoli fissi

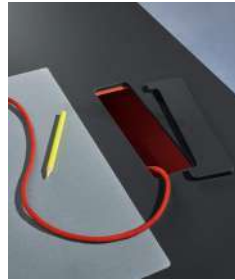

CDX / CSX

Hole with red (RO400) powder coated cable management and cover in the same material of the top.

Spacco per passaggio cavi con canalina verniciata rossa (RO400) e coperchio di chiusura dello stesso materiale del ripiano.

Frame Telaio			Cable management Canalina	Solid laminate top included Incluso ripiano in stratificato			Veneered top included Incluso ripiano in impiallacciato
Item Articolo	Sizes Dimensioni	Finish Finitura		CFC_BI (mm 12)	FNP_NE (mm 10)	COM 4512, 4529,4543, 1952 (mm 10)	RS (mm 25)
TOA240X90	2400X900	POWDER COATED / Verniciato	Without cable management Senza canalina	€ 2.439,00	€ 2.439,00	€ 1.967,00	€ 2.754,00
		LU		€ 3.006,00	€ 3.006,00	€ 2.534,00	€ 3.321,00
		TN		-	€ 3.226,00	€ 2.754,00	€ 3.540,00
TOA240X90_CD	2400X900	POWDER COATED / Verniciato	CDX	€ 3.022,00	€ 3.022,00	€ 2.550,00	-
		LU		€ 3.587,00	€ 3.587,00	€ 3.115,00	-
		TN		-	€ 3.808,00	€ 3.336,00	-
TOA240X90_CSX	2400X900	POWDER COATED / Verniciato	CSX	€ 3.022,00	€ 3.022,00	€ 2.550,00	-
		LU		€ 3.587,00	€ 3.587,00	€ 3.115,00	-
		TN		-	€ 3.808,00	€ 3.336,00	-

TECHNICAL DETAILS / Dettagli tecnici

Item TOA240X90

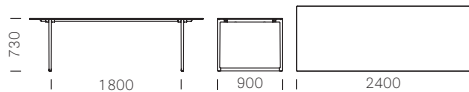

Item TOA240X90_CD

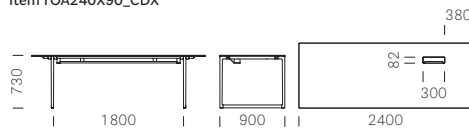

Item TOA240X90_CSX

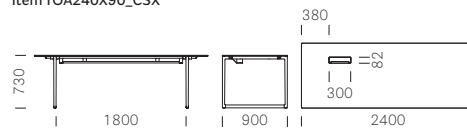

On request other standard colours powder coated available - same price
Disponibile a richiesta il telaio verniciato in altri colori standard, allo stesso prezzo

Solid laminate top finishes

Finiture ripiano in stratificato



Veneered top finishes

Finiture ripiano in impiallacciato



Frame finishes

Finiture telaio

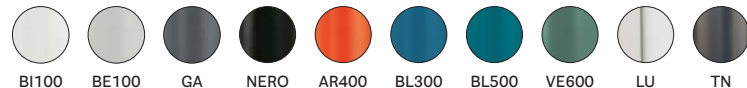

TOA table

Fixed tables / Tavoli fissi



Item Articolo	Frame Telaio		Solid laminate top included Incluso ripiano in stratificato				
	Sizes Dimensioni	Finish Finitura	CFC_BI (mm 12)	FNP_NE (mm 10)	FMP_NE (mm 12)	FNP_3452 (mm 10)	COM 4512, 4529, 4543,1952 (mm 10)
TOA190X75	1900X750	POWDER COATED / Verniciato	€ 1.573,00	€ 1.573,00	€ 1.573,00	€ 2.045,00	€ 1.338,00
		LU	€ 2.140,00	€ 2.140,00	-	-	€ 1.905,00
		TN	-	€ 2.360,00	-	€ 2.832,00	€ 2.125,00
TOA190X90	1900X900	POWDER COATED / Verniciato	€ 2.045,00	€ 2.045,00	€ 1.653,00	€ 2.125,00	€ 1.653,00
		LU	€ 2.612,00	€ 2.612,00	-	-	€ 2.220,00
		TN	-	€ 2.832,00	-	€ 2.911,00	€ 2.439,00
TOA300X100	3000X1000	POWDER COATED / Verniciato	€ 2.675,00	€ 2.675,00	€ 2.125,00	€ 2.832,00	€ 2.125,00
		LU	€ 3.241,00	€ 3.241,00	-	-	€ 2.691,00
		TN	-	€ 3.461,00	-	€ 3.618,00	€ 2.911,00
TOA300X125	3000X1250	POWDER COATED / Verniciato	€ 2.801,00	€ 2.801,00	-	€ 2.958,00	€ 2.251,00
		LU	€ 3.414,00	€ 3.414,00	-	-	€ 2.864,00
		TN	-	€ 3.666,00	-	€ 3.824,00	€ 3.115,00
TOA360X100	3600X1000	POWDER COATED / Verniciato	€ 3.146,00	€ 3.146,00	-	€ 3.304,00	€ 2.439,00
		LU	€ 3.713,00	€ 3.713,00	-	-	€ 3.006,00
		TN	-	€ 3.933,00	-	€ 4.090,00	€ 3.226,00
TOA360X125	3600X1250	POWDER COATED / Verniciato	€ 3.273,00	€ 3.273,00	-	€ 3.430,00	€ 2.565,00
		LU	€ 3.886,00	€ 3.886,00	-	-	€ 3.179,00
		TN	-	€ 4.138,00	-	€ 4.296,00	€ 3.430,00

TECHNICAL DETAILS / Dettagli tecnici

Item TOA190X75

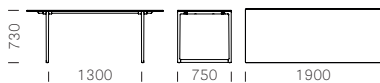

Item TOA190X90

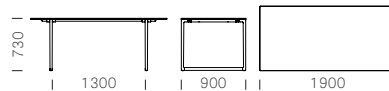

Item TOA300X100/125

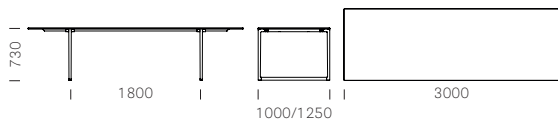

Item TOA360X100/125

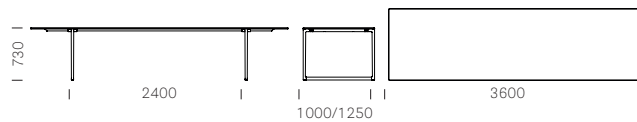

On request other standard colours powder coated available - same price
Disponibile a richiesta il telaio verniciato in altri colori standard, allo stesso prezzo

Solid laminate top finishes Finiture ripiano in stratificato

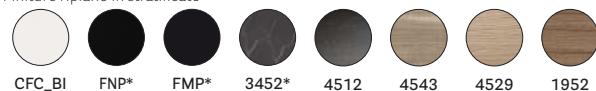

*Anti-fingerprint finish
Finitura anti-impronta

Frame finishes Finiture telaio

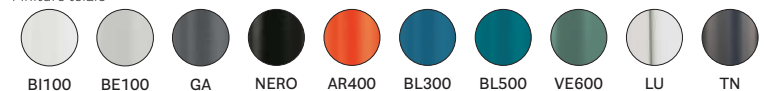

TOA table - Outdoor

Fixed tables / Tavoli fissi



VAT NOT INCLUDED / Iva esclusa

Tables / Tavoli



Frame Telaio			Solid laminate top included Incluso ripiano in stratificato			
Item Articolo	Sizes Dimensioni	Finish Finitura	CFC_BI (mm 12)	CFC 3445, 3447 (mm 10)	COM 3471 (mm 10)	COM 4529, 1952 (mm 10)
TOA190X75	1900X750	POWDER COATED / Verniciato	€ 1.888,00	€ 1.888,00	€ 1.888,00	€ 1.653,00
TOA190X90	1900X900	POWDER COATED / Verniciato	€ 2.360,00	€ 2.360,00	€ 2.360,00	€ 1.967,00
TOA300X100	3000X1000	POWDER COATED / Verniciato	€ 2.989,00	€ 2.989,00	€ 2.989,00	€ 2.439,00
TOA300X125	3000X1250	POWDER COATED / Verniciato	€ 3.115,00	€ 3.115,00	€ 3.115,00	€ 2.565,00
TOA360X100	3600X1000	POWDER COATED / Verniciato	€ 3.461,00	€ 3.461,00	€ 3.461,00	€ 2.754,00
TOA360X125	3600X1250	POWDER COATED / Verniciato	€ 3.587,00	€ 3.587,00	€ 3.587,00	€ 2.880,00

TECHNICAL DETAILS / Dettagli tecnici

Item TOA190X75

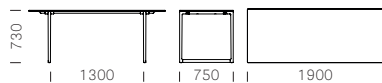

Item TOA190X90

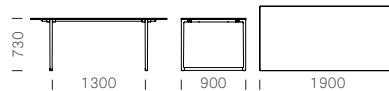

Item TOA300X100/125

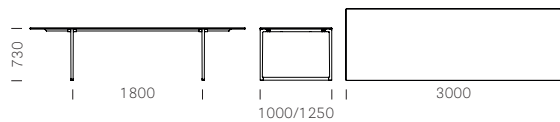

Item TOA360X100/125

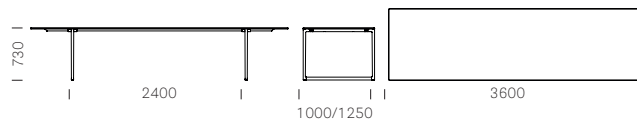

On request other standard colours powder coated available - same price
Disponibile a richiesta il telaio verniciato in altri colori standard, allo stesso prezzo

Solid laminate top finishes Finiture ripiano in stratificato



Frame finishes Finiture telaio



TOA table

Fixed tables - with cable management / Tavoli fissi - con canalina



CC60



CCO

Hole with black powder coated cable management and cover in the same material of the top.
Spacco per passaggio cavi con canalina verniciata nero e coperchio di chiusura dello stesso materiale del ripiano.



SPEC

Tailor made for different types to top access (power units not included).
Customizzabile con diversi tipi di top access (prese non include)

Item Articolo	Frame Telaio		Cable management Canalina	Solid laminate top included Incluso ripiano in stratificato		
	Sizes Dimensioni	Finish Finitura		CFC_BI (mm 12)	FNP_NE (mm 10)	COM 4512, 4529, 4543, 1952 (mm 10)
TOA300X100 CC60	3000X1000	POWDER COATED / Verniciato	CC60	€ 2.919,00	€ 2.919,00	€ 2.369,00
		LU		€ 3.486,00	€ 3.486,00	€ 2.935,00
		TN		-	€ 3.705,00	€ 3.156,00
TOA300X100 CCO	3000X1000	POWDER COATED / Verniciato	CCO	€ 3.037,00	€ 3.037,00	€ 2.486,00
		LU		€ 3.603,00	€ 3.603,00	€ 3.053,00
		TN		-	€ 3.824,00	€ 3.273,00
TOA300X100 SPEC	3000X1000	POWDER COATED / Verniciato	SPEC	€ 3.076,00	€ 3.076,00	€ 2.526,00
		LU		€ 3.643,00	€ 3.643,00	€ 3.092,00
		TN		-	€ 3.863,00	€ 3.313,00
TOA300X125 CC60	3000X1250	POWDER COATED / Verniciato	CC60	€ 3.045,00	€ 3.045,00	€ 2.494,00
		LU		€ 3.659,00	€ 3.659,00	€ 3.107,00
		TN		-	€ 3.910,00	€ 3.360,00
TOA300X125 CCO	3000X1250	POWDER COATED / Verniciato	CCO	€ 3.163,00	€ 3.163,00	€ 2.612,00
		LU		€ 3.776,00	€ 3.776,00	€ 3.226,00
		TN		-	€ 4.028,00	€ 3.478,00
TOA300X125 SPEC	3000X1250	POWDER COATED / Verniciato	SPEC	€ 3.202,00	€ 3.202,00	€ 2.651,00
		LU		€ 3.816,00	€ 3.816,00	€ 3.265,00
		TN		-	€ 4.067,00	€ 3.517,00
TOA360X100 CC60	3600X1000	POWDER COATED / Verniciato	CC60	€ 3.391,00	€ 3.391,00	€ 2.684,00
		LU		€ 3.958,00	€ 3.958,00	€ 3.249,00
		TN		-	€ 4.177,00	€ 3.470,00
TOA360X100 CCO	3600X1000	POWDER COATED / Verniciato	CCO	€ 3.886,00	€ 3.886,00	€ 3.179,00
		LU		€ 4.453,00	€ 4.453,00	€ 3.744,00
		TN		-	€ 4.673,00	€ 3.965,00
TOA360X100 SPEC	3600X1000	POWDER COATED / Verniciato	SPEC	€ 3.793,00	€ 3.793,00	€ 3.084,00
		LU		€ 4.358,00	€ 4.358,00	€ 3.651,00
		TN		-	€ 4.579,00	€ 3.871,00
TOA360X125 CC60	3600X1250	POWDER COATED / Verniciato	CC60	€ 3.517,00	€ 3.517,00	€ 2.808,00
		LU		€ 4.131,00	€ 4.131,00	€ 3.422,00
		TN		-	€ 4.381,00	€ 3.674,00
TOA360X125 CCO	3600X1250	POWDER COATED / Verniciato	CCO	€ 4.012,00	€ 4.012,00	€ 3.304,00
		LU		€ 4.626,00	€ 4.626,00	€ 3.917,00
		TN		-	€ 4.877,00	€ 4.170,00
TOA360X125 SPEC	3600X1250	POWDER COATED / Verniciato	SPEC	€ 3.917,00	€ 3.917,00	€ 3.210,00
		LU		€ 4.531,00	€ 4.531,00	€ 3.824,00
		TN		-	€ 4.783,00	€ 4.075,00

TECHNICAL DETAILS / Dettagli tecnici

Item TOA300X100/125 CC60

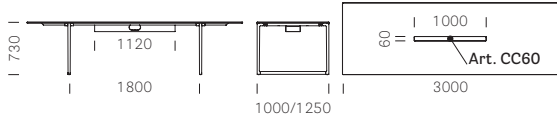

Item TOA300X100/125 CCO

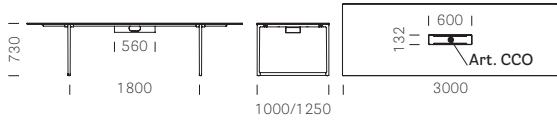

Item TOA300X100/125 SPEC

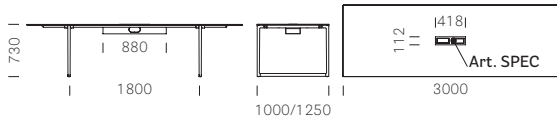

Item TOA360X100/125 CC60

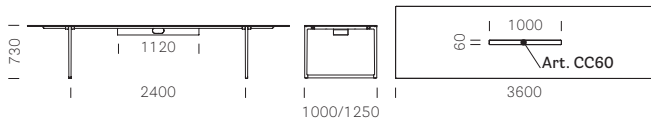

Item TOA360X100/125 CCO

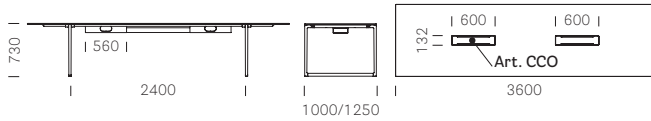

Item TOA360X100/125 SPEC

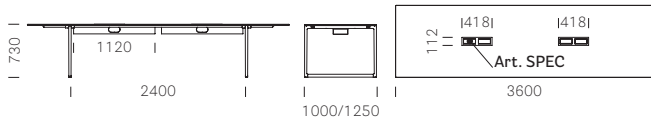

On request other standard colours powder coated available - same price
Disponibile a richiesta il telaio verniciato in altri colori standard, allo stesso prezzo

Solid laminate top finishes

Finiture ripiano in stratificato



Frame finishes

Finiture telaio

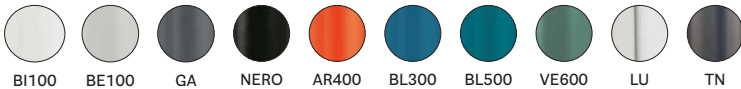

TOA conference

Fixed tables / Tavoli fissi



CC60



CCO

Hole with black powder coated cable management and cover in the same material of the top.
Spacco per passaggio cavi con canalina verniciata nero e coperchio di chiusura dello stesso materiale del ripiano.



SPEC

Tailor made for different types to top access (power units not included).
Customizzabile con diversi tipi di top access (prese non include)

Item Articolo	Frame Telaio		Cable management Canalina	Solid laminate top included Incluso ripiano in stratificato		
	Sizes Dimensioni	Finish Finitura		CFC_BI (mm 12)	FNP_NE (mm 10)	COM 4512, 4529, 4543, 1952 (mm 10)
TOA2_519X125	5190X1250	POWDER COATED / Verniciato	Without cable management Senza canalina	€ 5.191,00	€ 5.191,00	€ 4.090,00
		LU		€ 6.112,00	€ 6.112,00	€ 5.011,00
		TN		-	€ 6.490,00	€ 5.389,00
TOA2_519X125 CC60	5190X1250	POWDER COATED / Verniciato	CC60	€ 5.750,00	€ 5.750,00	€ 4.649,00
		LU		€ 6.671,00	€ 6.671,00	€ 5.570,00
		TN		-	€ 7.048,00	€ 5.947,00
TOA2_519X125 CCO	5190X1250	POWDER COATED / Verniciato	CCO	€ 5.987,00	€ 5.987,00	€ 4.886,00
		LU		€ 6.906,00	€ 6.906,00	€ 5.805,00
		TN		-	€ 7.284,00	€ 6.183,00
TOA2_519X125 SPEC	5190X1250	POWDER COATED / Verniciato	SPEC	€ 6.325,00	€ 6.325,00	€ 5.224,00
		LU		€ 7.245,00	€ 7.245,00	€ 6.144,00
		TN		-	€ 7.622,00	€ 6.521,00
TOA2_610X130	6100X1300	POWDER COATED / Verniciato	Without cable management Senza canalina	€ 5.506,00	€ 5.506,00	€ 4.405,00
		LU		€ 6.426,00	€ 6.426,00	€ 5.325,00
		TN		-	€ 6.805,00	€ 5.704,00
TOA2_610X130 CC60	6100X1300	POWDER COATED / Verniciato	CC60	€ 6.168,00	€ 6.168,00	€ 5.067,00
		LU		€ 7.088,00	€ 7.088,00	€ 5.987,00
		TN		-	€ 7.465,00	€ 6.364,00
TOA2_610X130 CCO	6100X1300	POWDER COATED / Verniciato	CCO	€ 6.797,00	€ 6.797,00	€ 5.696,00
		LU		€ 7.717,00	€ 7.717,00	€ 6.616,00
		TN		-	€ 8.094,00	€ 6.993,00
TOA2_610X130 SPEC	6100X1300	POWDER COATED / Verniciato	SPEC	€ 6.640,00	€ 6.640,00	€ 5.538,00
		LU		€ 7.560,00	€ 7.560,00	€ 6.459,00
		TN		-	€ 7.937,00	€ 6.836,00

TECHNICAL DETAILS / Dettagli tecnici

Item TOA2_519X125

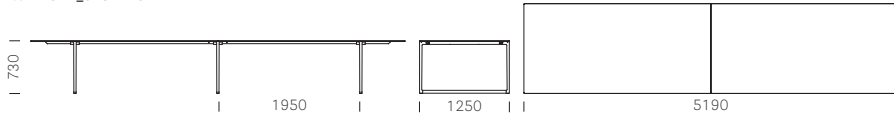

Item TOA2_519X125 CC60

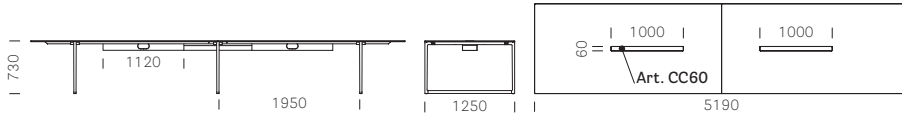

Item TOA2_519X125 CCO

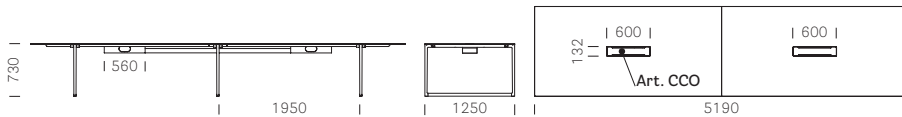

Item TOA2_519X125 SPEC

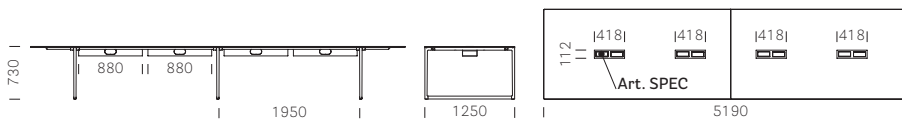

Item TOA2_610X130

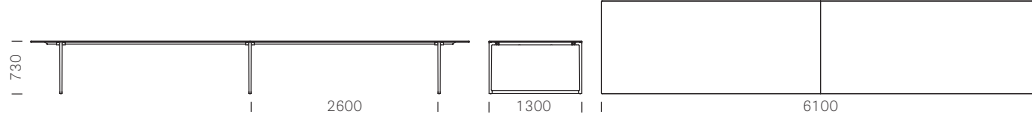

Item TOA2_610X130 CC60

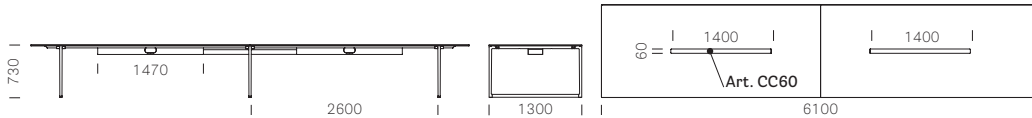

Item TOA2_610X130 CCO

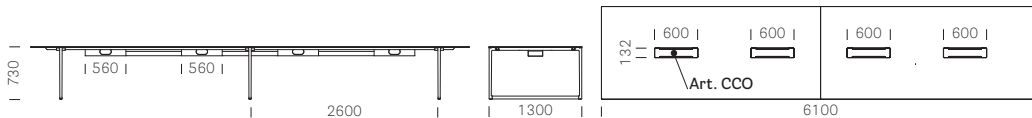

Item TOA2_610X130 SPEC

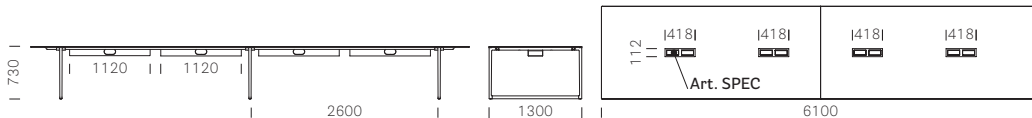

On request other standard colours powder coated available - same price
Disponibile a richiesta il telaio verniciato in altri colori standard, allo stesso prezzo

Solid laminate top finishes

Finiture ripiano in stratificato

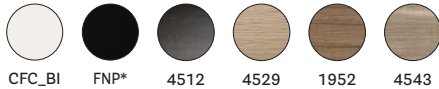

*Anti-fingerprint finish
Finitura anti-impronta

Frame finishes

Finiture telaio

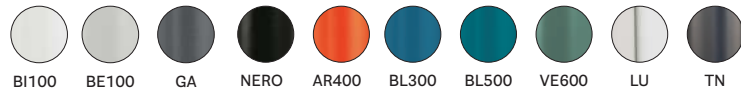

TOA workstation

Fixed tables / Tavoli fissi



Item Articolo	Frame Telaio Sizes Dimensioni	Finish Finitura	Solid laminate top included Incluso ripiano in stratificato			Fittings Accessori
			CFC_BI (mm 12)	FNP_NE (mm 10)	COM 4512, 4529, 4543, 1952 (mm 10)	
TOA3S_159X150	1590X1500	POWDER COATED / Verniciato	€ 2.360,00	€ 2.360,00	€ 1.879,00	-
		LU	€ 3.075,00	€ 3.075,00	€ 2.594,00	
		TN	-	€ 3.114,00	€ 2.633,00	
TOA3S_300X150	3000X1500	POWDER COATED / Verniciato	€ 4.297,00	€ 4.297,00	€ 3.348,00	-
		LU	€ 5.369,00	€ 5.369,00	€ 4.420,00	
		TN	-	€ 5.428,00	€ 4.479,00	
DSP_L130 Panel only (1 pc) Solo pannello (1 pz)	1300X455h	C210÷C217 D40÷D44 G* H60÷H61 H120÷H127	-	-	-	€ 367,00 € 463,00 € 584,00 € 411,00
DSP/2_L130 Panel only (1 pc) Solo pannello (1 pz)	1300X615h	C210÷C217 D40÷D44 G* H60÷H61 H120÷H127	-	-	-	€ 383,00 € 480,00 € 601,00 € 428,00

*Excluding / Escluso G220+G225, G230+G239

TECHNICAL DETAILS / Dettagli tecnici

Item TOA3S_159X150

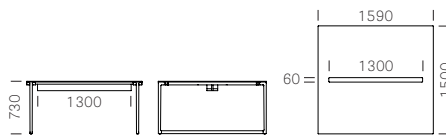

Item TOA3S_300X150



Accessori - Fittings

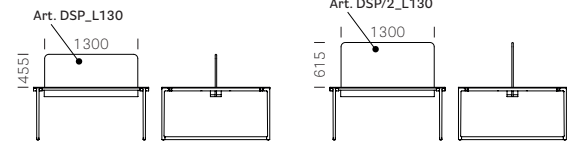

Accessori - Fittings

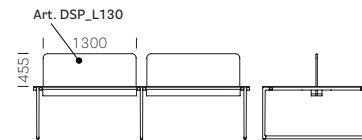

For fabrics see page 284
Per i tessuti si veda p. 284

On request other standard colours powder coated available - same price
Disponibile a richiesta il telaio verniciato in altri colori standard, allo stesso prezzo

Solid laminate top finishes
Finiture ripiano in stratificato

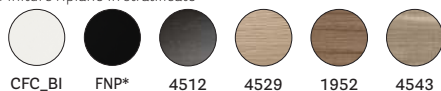

*Anti-fingerprint finish
Finitura anti-impronta

Frame finishes
Finiture telaio

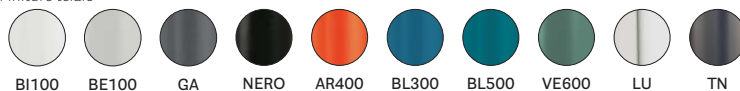



Solid laminate top
Ripiani in stratificato

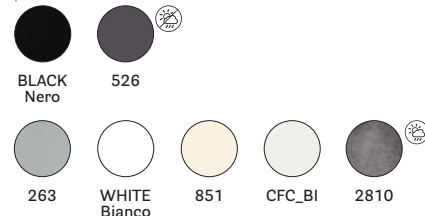

Item Articolo	Frame Telaio	Top Ripiano	Solid laminate top included Incluso ripiano in stratificato			Laminated top included Incluso ripiano in laminato	
			COM white bianco, black nero, 851, 526, 263 (mm 12)	COM 2810 (mm 12)	CFC_BI (mm 10)	BA_20 (mm 20)	BA_30 (mm 10)
		Sizes Dimensioni	Viti / Screw KIT.TJ4	Viti / Screw KIT.TJ4	Viti / Screw KIT.TJ4	Viti / Screw KIT.M6X16.TG	Viti / Screw KIT.M6X16.TG
TG	POWDER COATED / Verniciato	690X690	€ 436,00	€ 436,00	€ 520,00	€ 358,00	€ 394,00
		790X790	€ 480,00	€ 484,00	€ 575,00	€ 380,00	€ 428,00
		890X890	€ 552,00	€ 570,00	€ 660,00	€ 402,00	€ 467,00
		1390X1390	€ 1.250,00*	-	€ 1.590,00*	-	-
		1190X790	€ 662,00*	€ 670,00*	€ 803,00*	€ 479,00*	€ 502,00
		1390X890	€ 760,00*	€ 1.056,00*	€ 996,00*	€ 567,00*	€ 575,00
		1590X890	€ 875,00*	€ 1.085,00*	€ 1.050,00*	€ 591,00*	€ 600,00
	1990X890	-	-	-	€ 696,00*	€ 675,00	
	AS	690X690	€ 557,00	€ 557,00	€ 641,00	€ 479,00	€ 515,00
		790X790	€ 601,00	€ 605,00	€ 696,00	€ 501,00	€ 549,00
		890X890	€ 673,00	€ 691,00	€ 780,00	€ 523,00	€ 588,00
		1390X1390	€ 1.371,00*	-	€ 1.711,00*	-	-
		1190X790	€ 783,00*	€ 791,00*	€ 923,00*	€ 600,00*	€ 623,00
		1390X890	€ 881,00*	€ 1.177,00*	€ 1.117,00*	€ 688,00*	€ 696,00
1590X890		€ 996,00*	€ 1.206,00*	€ 1.170,00*	€ 712,00*	€ 721,00	
1990X890	-	-	-	€ 817,00*	€ 796,00		
TG_H110	POWDER COATED / Verniciato	700X700	-	-	-	-	€ 448,00
		800X800	-	-	-	-	€ 481,00
		1100X500	-	-	-	-	€ 532,00
		1200X600	-	-	-	-	€ 557,00
		1300X700	-	-	-	-	€ 595,00
	AS	700X700	-	-	-	-	€ 585,00
		800X800	-	-	-	-	€ 619,00
		1100X500	-	-	-	-	€ 670,00
		1200X600	-	-	-	-	€ 695,00
		1300X700	-	-	-	-	€ 732,00

* Price includes reinforcing bars / Il prezzo include i tubi di rinforzo

TECHNICAL DETAILS / Dettagli tecnici

Item TG

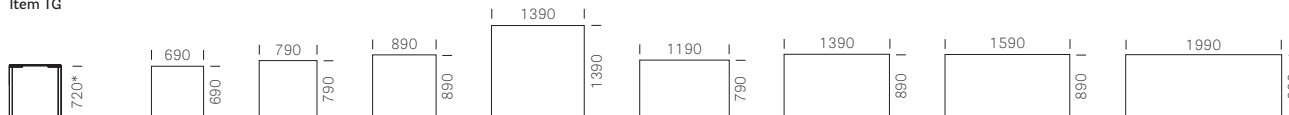

Item TG_H110

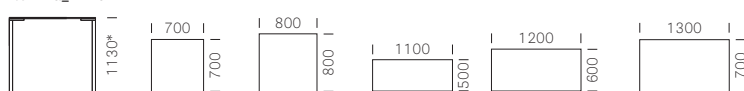

* Height of the table refers to solid laminate top
L'altezza del tavolo è riferita ai ripiani in stratificato

Laminate top finishes
Finiture ripiano laminato

ABET 312, 386, 406_0020, 1813_244, 421, 263

Wenge, bleached oak, white, ivory, black and grey laminate

Laminato color wengé, rovere sbiancato, bianco, avorio, nero e grigio

YPSILON Tilting

Tilting tables / Tavoli ribaltabili



Item Articolo	Frame Telaio		Top Ripiano Sizes Dimensioni	Solid laminate top included Incluso ripiano in stratificato					Laminate top included Incluso ripiano in laminato
	Frame Telaio	Finish Finitura		CFP_BI (mm 12) white core anima bianca	COP_623 (mm 10) black core anima nera	FNP_NE (mm 10) black core anima nera	COP_4511, 4512, 4517, 4519, 4543 (mm 10) brown core anima marrone	COP_4529 (mm 10) black core anima nera	BA_20 406_0020, 421, 4511, 4512, 4517, 4519, 4529, 4543 (mm 20)
TYT 119X79	TYT_800	POWDER COATED Verniciato	1190X790	€ 968,00	€ 939,00	€ 803,00	€ 654,00		
		POLISHED ALUMINIUM Alluminio lucidato		€ 1.066,00	€ 1.037,00	€ 901,00	€ 753,00		
TYT 129X79	TYT_800	POWDER COATED Verniciato	1290X790	€ 1.017,00	€ 987,00	€ 835,00	€ 654,00		
		POLISHED ALUMINIUM Alluminio lucidato		€ 1.116,00	€ 1.087,00	€ 935,00	€ 753,00		
TYT 139X89	TYT_800	POWDER COATED Verniciato	1390X890	€ 1.108,00	€ 1.066,00	€ 884,00	€ 687,00		
		POLISHED ALUMINIUM Alluminio lucidato		€ 1.207,00	€ 1.165,00	€ 985,00	€ 786,00		
TYT 158X79	TYT_1000	POWDER COATED Verniciato	1580X790	€ 1.191,00	€ 1.141,00	€ 935,00	€ 712,00		
		POLISHED ALUMINIUM Alluminio lucidato		€ 1.290,00	€ 1.241,00	€ 1.034,00	€ 810,00		
TYT 159X89	TYT_1000	POWDER COATED Verniciato	1590X890	€ 1.191,00	€ 1.141,00	€ 935,00	€ 712,00		
		POLISHED ALUMINIUM Alluminio lucidato		€ 1.290,00	€ 1.241,00	€ 1.034,00	€ 810,00		
TYT 159X99	TYT_1000	POWDER COATED Verniciato	1590X990	€ 1.269,00	€ 1.191,00	€ 951,00	€ 793,00		
		POLISHED ALUMINIUM Alluminio lucidato		€ 1.368,00	€ 1.290,00	€ 1.050,00	€ 894,00		
TYT 178X89	TYT_1100	POWDER COATED Verniciato	1780X890	€ 1.306,00	€ 1.224,00	€ 975,00	€ 736,00		
		POLISHED ALUMINIUM Alluminio lucidato		€ 1.406,00	€ 1.323,00	€ 1.076,00	€ 835,00		
TYT 189X99	TYT_1100	POWDER COATED Verniciato	1890X990	€ 1.397,00	€ 1.306,00	€ 1.042,00	€ 793,00		
		POLISHED ALUMINIUM Alluminio lucidato		€ 1.497,00	€ 1.406,00	€ 1.141,00	€ 894,00		
TYT 198X99	TYT_1100	POWDER COATED Verniciato	1980X990	€ 1.471,00	€ 1.380,00	€ 1.076,00	€ 793,00		
		POLISHED ALUMINIUM Alluminio lucidato		€ 1.571,00	€ 1.480,00	€ 1.174,00	€ 894,00		

On request, version without wheels also available – same price
Disponibile a richiesta il tavolo fisso, senza rotelle, allo stesso prezzo

Linking devices 3350 available on request - € 21,00
Disponibile a richiesta il gancio di collegamento 3350 - € 21,00

TECHNICAL DETAILS / Dettagli tecnici

Item TYT 119/129X79



Item TYT 139X89



Item TYT 158X79

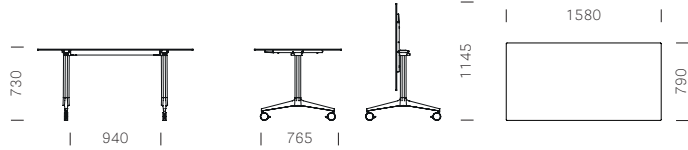

Item TYT 159X89/99

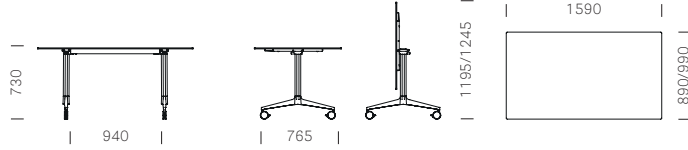

Item TYT 178X89

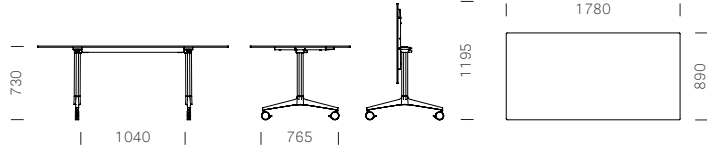

Item TYT 189/198X99

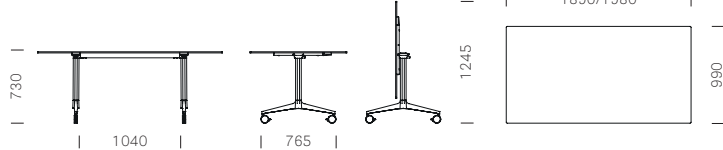

Solid laminate top and powder coated or polished frame finishes

Finiture ripiano in stratificato e telaio verniciato o lucidato



*Anti-fingerprint finish
Finitura anti-impronta



Laminate top and powder coated or polished frame finishes

Finiture ripiano in laminato e telaio verniciato o lucidato

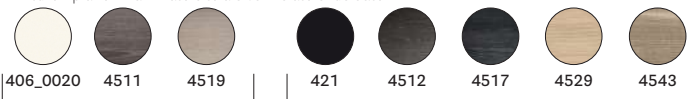

Arki-Base



CODE Codice	CROSS Crociera	FEET Piedino	POWDER COATED Verniciato	OUTDOOR FINISHES Finiture per esterno	CORTEN Effetto Corten
ARK3			€ 134,00	€ 154,00 ☀️	
	Mod. 4006	SPEC			
ARK3/EC					€ 228,00

PACKING / Imballo

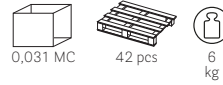

TECHNICAL DETAILS / Dettagli tecnici



Arki-Base



CODE Codice	CROSS Crociera	FEET Piedino	POWDER COATED Verniciato	OUTDOOR FINISHES Finiture per esterno	CORTEN Effetto Corten
ARK4			€ 162,00	€ 186,00 ☀️	
	Mod. 4000	SPEC			
ARK4/EC					€ 279,00

PACKING / Imballo

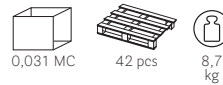

TECHNICAL DETAILS / Dettagli tecnici



Arki-Base



CODE Codice	CROSS Crociera	FEET Piedino	POWDER COATED Verniciato	OUTDOOR FINISHES Finiture per esterno	CORTEN Effetto Corten
ARK4H105			€ 193,00	€ 224,00 ☀️	
	Mod. 4000	SPEC			
ARK4H105/EC					€ 358,00

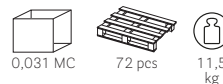

PACKING / Imballo

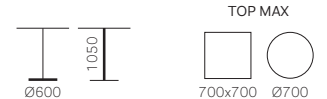

TECHNICAL DETAILS / Dettagli tecnici



Bold

CODE Codice	CROSS Crociera	FEET Piedino	BLACK POWDER COATED Verniciato nero	POWDER COATED Verniciato	OUTDOOR FINISHES Finiture per esterno
4750*	Mod. 4000NY*	1003 			€ 159,00 
4750	Mod. 4000		€ 124,00	€ 133,00	



PACKING / Imballo



TECHNICAL DETAILS / Dettagli tecnici
TOP MAX



Bold

CODE Codice	CROSS Crociera	FEET Piedino	BLACK POWDER COATED Verniciato nero	POWDER COATED Verniciato	OUTDOOR FINISHES Finiture per esterno
4753	Mod. 4006	1003 	€ 132,00	€ 141,00	€ 167,00 



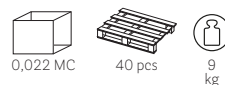

PACKING / Imballo



TECHNICAL DETAILS / Dettagli tecnici
TOP MAX



Bold

CODE Codice	CROSS Crociera	FEET Piedino	BLACK POWDER COATED Verniciato nero	POWDER COATED Verniciato	OUTDOOR FINISHES Finiture per esterno
4752*	Mod. 4000NY*	1003 			€ 192,00 
4752	Mod. 4000		€ 156,00	€ 166,00	



PACKING / Imballo









TECHNICAL DETAILS / Dettagli tecnici
TOP MAX





Bold





CODE Codice	CROSS Crociera	FEET Piedino	BLACK POWDER COATED Verniciato nero	POWDER COATED Verniciato	OUTDOOR FINISHES Finiture per esterno
4752 H500*	Mod. 4000NY*	1003 			€ 199,00 
4752 H500	Mod. 4000		€ 164,00	€ 173,00	





PACKING / Imballo
 0,037 MC  40 pcs  10,5* kg  12,5 kg



TECHNICAL DETAILS / Dettagli tecnici
 TOP MAX
 500
 Ø700 530x530  900x900  Ø900

Bold





CODE Codice	CROSS Crociera	FEET Piedino	BLACK POWDER COATED Verniciato nero	POWDER COATED Verniciato	OUTDOOR FINISHES Finiture per esterno
4754*	Mod. 4000NY*	1003 			€ 185,00 
4754	Mod. 4000		€ 150,00	€ 159,00	





PACKING / Imballo
 0,031 MC  36 pcs  9* kg  11 kg



TECHNICAL DETAILS / Dettagli tecnici
 TOP MAX
 1100
 Ø480 375x375  600x600  Ø600

Bold









CODE Codice	CROSS Crociera	FEET Piedino	BLACK POWDER COATED Verniciato nero	POWDER COATED Verniciato	OUTDOOR FINISHES Finiture per esterno
4756*	Mod. 4000NY*	1003 			€ 218,00 
4756	Mod. 4000		€ 182,00	€ 192,00	

PACKING / Imballo
 0,036 MC  32 pcs  11,5* kg  13,5 kg

TECHNICAL DETAILS / Dettagli tecnici
 TOP MAX
 1100
 Ø700 530x530  700x700  Ø700







Bold



CODE Codice	CROSS Crociera	FEET Piedino	BLACK POWDER COATED Verniciato nero	POWDER COATED Verniciato	OUTDOOR FINISHES Finiture per esterno	
4757	2xMod. 4002	1003 	€ 208,00	€ 218,00	€ 244,00 	
			PACKING / Imballo  0,031 MC  42 pcs  18 kg		TECHNICAL DETAILS / Dettagli tecnici TOP MAX  2x630x65 730 2x Ø50  1400x900	









Bold



CODE Codice	CROSS Crociera	FEET Piedino	BLACK POWDER COATED Verniciato nero	POWDER COATED Verniciato	OUTDOOR FINISHES Finiture per esterno	
4757 H500	2xMod. 4002	1003 	€ 216,00	€ 225,00	€ 251,00 	
			PACKING / Imballo  0,031 MC  42 pcs  16 kg		TECHNICAL DETAILS / Dettagli tecnici TOP MAX  2x630x65 500 2x Ø50  1400x900	



Bold









CODE Codice	CROSS Crociera	FEET Piedino	BLACK POWDER COATED Verniciato nero	POWDER COATED Verniciato	OUTDOOR FINISHES Finiture per esterno	
4758*	2xMod. 4000NY*	1003 			€ 270,00 	
4758	2xMod. 4000		€ 234,00	€ 244,00		
			PACKING / Imballo  0,037 MC  40 pcs  17* kg  21 kg		TECHNICAL DETAILS / Dettagli tecnici TOP MAX  980x530 730 2x Ø50  1600x900	

Bold



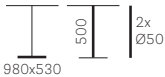

CODE Codice	CROSS Crociera	FEET Piedino	BLACK POWDER COATED Verniciato nero	POWDER COATED Verniciato	OUTDOOR FINISHES Finiture per esterno
4758 H500*	2xMod. 4000NY*	1003 			€ 277,00 
4758 H500	2xMod. 4000		€ 242,00	€ 251,00	



PACKING / Imballo
 0,037 MC  40 pcs  16* kg  20 kg



TECHNICAL DETAILS / Dettagli tecnici
 TOP MAX
 980x530 | 500 | 2x Ø50  1600x900

Bold



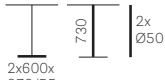

CODE Codice	CROSS Crociera	FEET Piedino	BLACK POWDER COATED Verniciato nero	POWDER COATED Verniciato	OUTDOOR FINISHES Finiture per esterno
4759	2xMod. 4002	1003 	€ 232,00	€ 241,00	€ 267,00 



PACKING / Imballo
 0,031 MC  42 pcs  20 kg



TECHNICAL DETAILS / Dettagli tecnici
 TOP MAX
 2x600x 270/55 | 730 | 2x Ø50  1400x900

Bold



CODE Codice	CROSS Crociera	FEET Piedino	BLACK POWDER COATED Verniciato nero	POWDER COATED Verniciato	OUTDOOR FINISHES Finiture per esterno
4759 H500	2xMod. 4002	1003 	€ 241,00	€ 250,00	€ 276,00 

PACKING / Imballo
 0,031 MC  42 pcs  18 kg

TECHNICAL DETAILS / Dettagli tecnici
 TOP MAX
 2x600x 270/55 | 500 | 2x Ø50  1400x900

For colours and finishes see at page 280
 Per colori e finiture vedere da pagina 280

Concrete

Concrete base
Base in cemento



CODE Codice	CROSS Crociera	FEET Piedino	OUTDOOR FINISHES Finiture per esterno
855	Mod. 4000	SPEC	€ 197,00

In case of order please mention the colour for the powder-coated column. See page 281
In caso di ordine vi preghiamo di precisare il colore della colonna verniciata. Vedere pagina 281

PACKING / Imballo

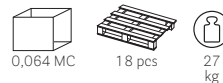

TECHNICAL DETAILS / Dettagli tecnici
TOP MAX



Concrete

Concrete base
Base in cemento



CODE Codice	CROSS Crociera	FEET Piedino	OUTDOOR FINISHES Finiture per esterno
855 H500	Mod. 4000	SPEC	€ 205,00

In case of order please mention the colour for the powder-coated column. See page 281
In caso di ordine vi preghiamo di precisare il colore della colonna verniciata. Vedere pagina 281

PACKING / Imballo

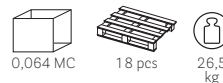

TECHNICAL DETAILS / Dettagli tecnici
TOP MAX



Concrete

Concrete base
Base in cemento



CODE Codice	CROSS Crociera	FEET Piedino	OUTDOOR FINISHES Finiture per esterno
855 H1100	Mod. 4000	SPEC	€ 223,00

In case of order please mention the colour for the powder-coated column. See page 281
In caso di ordine vi preghiamo di precisare il colore della colonna verniciata. Vedere pagina 281

PACKING / Imballo

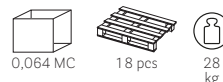



TECHNICAL DETAILS / Dettagli tecnici
TOP MAX



For colours and finishes see at page 280
Per colori e finiture vedere da pagina 280

Elliot



CODE Codice	CROSS Crociera	FEET Piedino	POWDER COATED Verniciato	POWDER COATED FOR OUTDOOR Verniciato per esterno	POLISHED ALUMINIUM Alluminio lucidato	ANTIQUE BRASS Ottone anticato	TITANIUM Titanio	
5470			€ 166,00	€ 192,00 				
5470/LU	Mod. 5470.3	1001 			€ 207,00			
5470/OA						€ 345,00		
5470/TN								€ 345,00

PACKING / Imballo

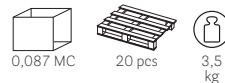



TECHNICAL DETAILS / Dettagli tecnici
TOP MAX



Elliot



CODE Codice	CROSS Crociera	FEET Piedino	POWDER COATED Verniciato	POWDER COATED FOR OUTDOOR Verniciato per esterno	POLISHED ALUMINIUM Alluminio lucidato	ANTIQUE BRASS Ottone anticato	TITANIUM Titanio	
5473			€ 173,00	€ 199,00 				
5473/LU	Mod. 5470.3	1001 			€ 215,00			
5473/OA						€ 353,00		
5473/TN								€ 353,00

PACKING / Imballo

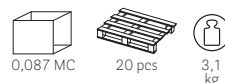



TECHNICAL DETAILS / Dettagli tecnici
TOP MAX

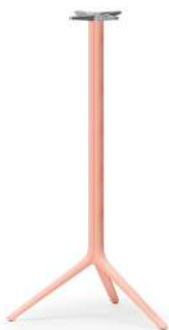

Elliot



CODE Codice	CROSS Crociera	FEET Piedino	POWDER COATED Verniciato	POWDER COATED FOR OUTDOOR Verniciato per esterno	POLISHED ALUMINIUM Alluminio lucidato	ANTIQUE BRASS Ottone anticato	TITANIUM Titanio	
5474			€ 199,00	€ 225,00 				
5474/LU	Mod. 5470.3	1001 			€ 241,00			
5474/OA						€ 379,00		
5474/TN								€ 379,00

PACKING / Imballo

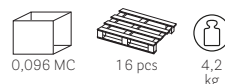

TECHNICAL DETAILS / Dettagli tecnici
TOP MAX



Elliot

Folding
Reclinabile

CODE Codice	CROSS Crociera	FEET Piedino	POWDER COATED Verniciato	POWDER COATED FOR OUTDOOR Verniciato per esterno	POLISHED ALUMINIUM Alluminio lucidato	ANTIQUE BRASS Ottone anticato	TITANIUM Titanio	
5470T			€ 192,00	€ 218,00 				
5470T/LU	Mod. 4040.10	1001 			€ 233,00			
5470T/OA						€ 371,00		
5470T/TN								€ 371,00

PACKING / Imballo

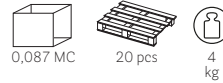

TECHNICAL DETAILS / Dettagli tecnici



Elliot

Folding
Reclinabile

CODE Codice	CROSS Crociera	FEET Piedino	POWDER COATED Verniciato	POWDER COATED FOR OUTDOOR Verniciato per esterno	POLISHED ALUMINIUM Alluminio lucidato	ANTIQUE BRASS Ottone anticato	TITANIUM Titanio	
5474T			€ 225,00	€ 251,00 				
5474T/LU	Mod. 4040.10	1001 			€ 267,00			
5474T/OA						€ 405,00		
5474T/TN								€ 405,00

PACKING / Imballo

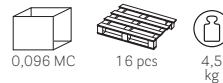

TECHNICAL DETAILS / Dettagli tecnici



Elliot



CODE Codice	CROSS Crociera	FEET Piedino	POWDER COATED Verniciato	POWDER COATED FOR OUTDOOR Verniciato per esterno	POLISHED ALUMINIUM Alluminio lucidato	ANTIQUE BRASS Ottone anticato	TITANIUM Titanio	
5475			€ 184,00	€ 216,00 				
5475/LU	Mod. 5475.3	1003 			€ 233,00			
5475/OA						€ 403,00		
5475/TN								€ 403,00

PACKING / Imballo

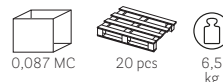



TECHNICAL DETAILS / Dettagli tecnici



Elliot



CODE Codice	CROSS Crociera	FEET Piedino	POWDER COATED Verniciato	POWDER COATED FOR OUTDOOR Verniciato per esterno	POLISHED ALUMINIUM Alluminio lucidato	ANTIQUE BRASS Ottone anticato	TITANIUM Titanio
5475 H500			€ 192,00	€ 224,00 			
5475/LU H500	Mod. 5475.3	1003 			€ 241,00		
5475/OA H500					€ 411,00		
5475/TN H500					€ 411,00		

PACKING / Imballo

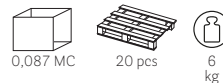



TECHNICAL DETAILS / Dettagli tecnici
TOP MAX



Elliot



CODE Codice	CROSS Crociera	FEET Piedino	POWDER COATED Verniciato	POWDER COATED FOR OUTDOOR Verniciato per esterno	POLISHED ALUMINIUM Alluminio lucidato	ANTIQUE BRASS Ottone anticato	TITANIUM Titanio
5476			€ 218,00	€ 250,00 			
5476/LU	Mod. 5475.3	1003 			€ 267,00		
5476/OA					€ 437,00		
5476/TN					€ 437,00		

PACKING / Imballo

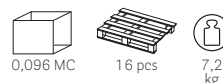



TECHNICAL DETAILS / Dettagli tecnici
TOP MAX



Elliot



CODE Codice	CROSS Crociera	FEET Piedino	POWDER COATED Verniciato	POWDER COATED FOR OUTDOOR Verniciato per esterno	POLISHED ALUMINIUM Alluminio lucidato	ANTIQUE BRASS Ottone anticato	TITANIUM Titanio
5477			€ 225,00	€ 258,00 			
5477/LU	Mod. 5475.3	1003 			€ 275,00		
5477/OA					€ 445,00		
5477/TN					€ 445,00		

PACKING / Imballo

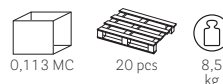

TECHNICAL DETAILS / Dettagli tecnici
TOP MAX



Elliot



CODE Codice	CROSS Crociera	FEET Piedino	POWDER COATED Verniciato	POWDER COATED FOR OUTDOOR Verniciato per esterno	POLISHED ALUMINIUM Alluminio lucidato	ANTIQUE BRASS Ottone anticato	TITANIUM Titanio	
5477 H500			€ 233,00	€ 266,00				
5477/LU H500	Mod. 5475.3	1003 			€ 283,00			
5477/OA H500						€ 453,00		
5477/TN H500								€ 453,00

PACKING / Imballo

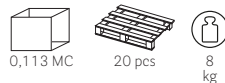
TECHNICAL DETAILS / Dettagli tecnici
TOP MAX

Fluxo



CODE Codice	CROSS Crociera	FEET Piedino	POWDER COATED Verniciato	POWDER COATED FOR OUTDOOR Verniciato per esterno	POLISHED ALUMINIUM Alluminio lucidato	ANTIQUE BRASS Ottone anticato	TITANIUM Titanio	
5460	Mod. 4000		€ 163,00					
5460*	Mod. 4000NY*			€ 189,00				
5460/LU	Mod. 4000	1001 			€ 197,00			
5460/OA						€ 325,00		
5460/TN								€ 325,00

PACKING / Imballo

TECHNICAL DETAILS / Dettagli tecnici
TOP MAX

Fluxo





CODE Codice	CROSS Crociera	FEET Piedino	POWDER COATED Verniciato	POWDER COATED FOR OUTDOOR Verniciato per esterno	POLISHED ALUMINIUM Alluminio lucidato	ANTIQUE BRASS Ottone anticato	TITANIUM Titanio	
5463			€ 171,00	€ 197,00				
5463/LU	Mod. 4006	1001 			€ 205,00			
5463/OA						€ 333,00		
5463/TN								€ 333,00

PACKING / Imballo

TECHNICAL DETAILS / Dettagli tecnici
TOP MAX

Fluxo

CODE Codice	CROSS Crociera	FEET Piedino	POWDER COATED Verniciato	POWDER COATED FOR OUTDOOR Verniciato per esterno	POLISHED ALUMINIUM Alluminio lucidato	ANTIQUE BRASS Ottone anticato	TITANIUM Titanio
5464	Mod. 4000		€ 189,00				
5464*	Mod. 4000NY*	1001		€ 215,00 			
5464/LU					€ 223,00		
5464/OA	Mod. 4000					€ 351,00	
5464/TN							€ 351,00



PACKING / Imballo

TECHNICAL DETAILS / Dettagli tecnici
TOP MAX

Fluxo



CODE Codice	CROSS Crociera	FEET Piedino	POWDER COATED Verniciato	POWDER COATED FOR OUTDOOR Verniciato per esterno	POLISHED ALUMINIUM Alluminio lucidato	ANTIQUE BRASS Ottone anticato	TITANIUM Titanio
5465	Mod. 4000		€ 172,00				
5465*	Mod. 4000NY*	1006		€ 198,00 			
5465/LU					€ 220,00		
5465/OA	Mod. 4000					€ 362,00	
5465/TN							€ 362,00



PACKING / Imballo

TECHNICAL DETAILS / Dettagli tecnici
TOP MAX

Fluxo

CODE Codice	CROSS Crociera	FEET Piedino	POWDER COATED Verniciato	POWDER COATED FOR OUTDOOR Verniciato per esterno	POLISHED ALUMINIUM Alluminio lucidato	ANTIQUE BRASS Ottone anticato	TITANIUM Titanio
5465 H500	Mod. 4000		€ 180,00				
5465 H500*	Mod. 4000NY*	1006		€ 206,00 			
5465/LU H500					€ 228,00		
5465/OA H500	Mod. 4000					€ 370,00	
5465/TN H500							€ 370,00



PACKING / Imballo

TECHNICAL DETAILS / Dettagli tecnici
TOP MAX

Fluxo



CODE Codice	CROSS Crociera	FEET Piedino	POWDER COATED Verniciato	POWDER COATED FOR OUTDOOR Verniciato per esterno	POLISHED ALUMINIUM Alluminio lucidato	ANTIQUÉ BRASS Ottone anticato	TITANIUM Titanio
5466	Mod. 4000		€ 198,00				
5466*	Mod. 4000NY*	1006		€ 224,00			
5466/LU					€ 246,00		
5466/OA	Mod. 4000					€ 388,00	
5466/TN							€ 388,00

PACKING / Imballo



TECHNICAL DETAILS / Dettagli tecnici
TOP MAX



Ikon



CODE Codice	CROSS Crociera	FEET Piedino	POLYPROPYLENE Polipropilene				
865					€ 150,00		
865_AD*	Mod. 865.3	865.2			€ 156,00	Assembled Montato	

POLYPROPYLENE FINISHES / Finiture polipropilene

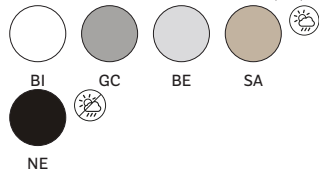

PACKING / Imballo

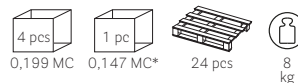

TECHNICAL DETAILS / Dettagli tecnici
TOP MAX



Ikon

For glass tops
Per ripiani in vetro



CODE Codice	CROSS Crociera	FEET Piedino	POLYPROPYLENE Polipropilene				
865V		865.2			€ 115,00		

POLYPROPYLENE FINISHES / Finiture polipropilene

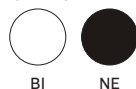

PACKING / Imballo

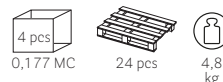

TECHNICAL DETAILS / Dettagli tecnici
TOP MAX



For colours and finishes see at page 280
Per colori e finiture vedere da pagina 280

Ikon

With ballast
Con zavorra



CODE Codice	CROSS Crociera	FEET Piedino	POLYPROPYLENE Polipropilene
866	Mod. 865.3	1008 	€ 219,00

POLYPROPYLENE FINISHES / Finiture polipropilene



PACKING / Imballo

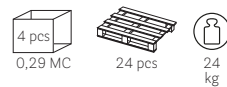

TECHNICAL DETAILS / Dettagli tecnici
TOP MAX

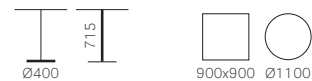

Ikon



CODE Codice	CROSS Crociera	FEET Piedino	POLYPROPYLENE Polipropilene
863	Mod. 865.3	865.2	€ 121,00
863_AD*			€ 127,00 Assembled Montato

POLYPROPYLENE FINISHES / Finiture polipropilene

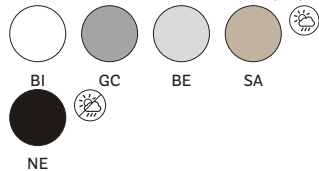

PACKING / Imballo

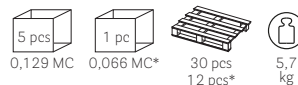

TECHNICAL DETAILS / Dettagli tecnici
TOP MAX



Ikon

For glass tops
Per ripiani in vetro



CODE Codice	CROSS Crociera	FEET Piedino	POLYPROPYLENE Polipropilene
863V		865.2	€ 80,00

POLYPROPYLENE FINISHES / Finiture polipropilene

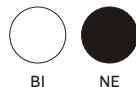

PACKING / Imballo

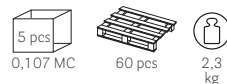

TECHNICAL DETAILS / Dettagli tecnici
TOP MAX

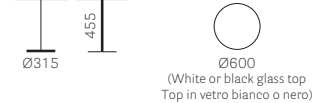

Ikon



CODE Codice	CROSS Crociera	FEET Piedino	POLYETHYLENE Polietilene
867	Mod. 867.3		<p>€ 251,00 </p> <p>Assembled Montato</p>

Surcharge for optional ballast: € 192,00
Supplemento per zavorra accessoria (Art. 867/10)

POLYETHYLENE FINISHES / Finiture polietilene

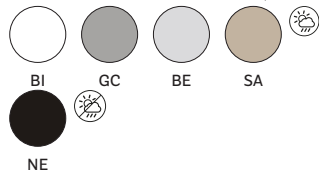

PACKING / Imballo



TECHNICAL DETAILS / Dettagli tecnici



Ikon

Luminous
Luminoso



CODE Codice	CROSS Crociera	FEET Piedino	POLYETHYLENE Polietilene
868	Mod. 867.3		<p>€ 335,00 </p> <p>Assembled Montato</p>

POLYETHYLENE FINISHES / Finiture polietilene



PACKING / Imballo



TECHNICAL DETAILS / Dettagli tecnici



Ikon

To be filled
Da zavorrare



CODE Codice	CROSS Crociera	FEET Piedino	POLYETHYLENE Polietilene
869	Mod. 869.3		<p>€ 296,00 </p> <p>Assembled Montato</p>

With laminate top / Con ripiano laminato Ø1300 mm, thickness / sp 30 mm: **€ 848,00**
With laminate top / Con ripiano laminato Ø1500 mm, thickness / sp 30 mm: **€ 1.126,00**
With laminate top / Con ripiano laminato Ø1600 mm, thickness / sp 30 mm: **€ 1.229,00**

POLYETHYLENE FINISHES / Finiture polietilene



PACKING / Imballo



TECHNICAL DETAILS / Dettagli tecnici



LAMINATE TOP FINISHES / Finiture ripiano laminato

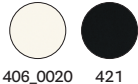

Ikon

To be filled. For tops thickness up to 20mm
Da zavorrare. Per ripiani con spessore fino a 20mm



CODE Codice	CROSS Crociera	FEET Piedino	POLYETHYLENE Polietilene
869/2	Mod. 869.10		<p>€ 546,00 </p> <p>€ 497,00</p>

POLYETHYLENE FINISHES / Finiture polietilene



PACKING / Imballo



TECHNICAL DETAILS / Dettagli tecnici

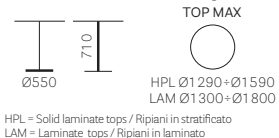

Ikon

With ballast
Con zavorra



CODE Codice	CROSS Crociera	FEET Piedino	POLYETHYLENE Polietilene
869/3	SPEC		€ 645,00

POLYETHYLENE FINISHES / Finiture polietilene

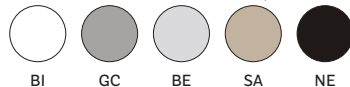

PACKING / Imballo



TECHNICAL DETAILS / Dettagli tecnici

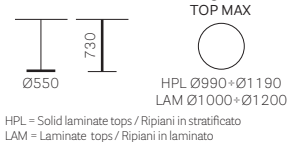

Inox



CODE Codice	CROSS Crociera	FEET Piedino	BLACK POWDER COATED Verniciato nero	POWDER COATED Verniciato	GOLD LACQUERED Laccato oro	BRUSHED S/STEEL Inox satinato	POLISHED S/STEEL Inox lucido	CORTEN Effetto Corten	ANTIQUE BRASS/ COPPER/BRONZE Ottone/rame/bronzo antico
4400 4401/VOR 4401/AC 4401/LU 4401/EC 4401/OA 4401/RM 4401/BS	Mod. 4000	1001 	€ 134,00	€ 146,00	€ 290,00	€ 177,00	€ 189,00	€ 216,00	€ 290,00 € 290,00 € 290,00
4401/VOR REG 4401/AC REG 4401/LU REG 4401/EC REG 4401/OA REG 4401/RM REG 4401/BS REG		1003 			€ 299,00	€ 185,00	€ 197,00	€ 225,00	€ 299,00 € 299,00 € 299,00

PACKING / Imballo



0,035 MC

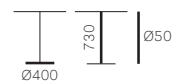

40 pcs

13,5
kgTECHNICAL DETAILS / Dettagli tecnici
TOP MAX

Ø400

730



Ø50



Ø700

Inox



CODE Codice	CROSS Crociera	FEET Piedino	BRUSHED S/STEEL Inox satinato	POLISHED S/STEEL Inox lucido
4401/FX	Mod. 4008	1001 	€ 236,00	€ 249,00
4401/FX REG		1003 	€ 245,00	€ 257,00

PACKING / Imballo



0,029 MC



30 pcs

14,6
kgTECHNICAL DETAILS / Dettagli tecnici
TOP MAX

Ø400

730

Ø76



Ø700

Inox



CODE Codice	CROSS Crociera	FEET Piedino	BLACK POWDER COATED Verniciato nero	POWDER COATED Verniciato	GOLD LACQUERED Laccato oro	BRUSHED S/STEEL Inox satinato	POLISHED S/STEEL Inox lucido	CORTEN Effetto Corten	ANTIQUE BRASS/ COPPER/BRONZE Ottone/rame/bronzo antico
4400 H500 4401/VOR H500 4401/AC H500 4401/LU H500 4401/EC H500 4401/OA H500 4401/RM H500 4401/BS H500 4401/FX H500*	Mod. 4006	1001 	€ 134,00	€ 146,00	€ 290,00	€ 177,00	€ 189,00	€ 216,00	€ 290,00 € 290,00 € 290,00
	Mod. 4001*					€ 236,00	€ 249,00		

PACKING / Imballo



0,022 MC



40 pcs

12
kgTECHNICAL DETAILS / Dettagli tecnici
TOP MAX

Ø400

500

Ø50
Ø76*

Ø600

Inox



CODE Codice	CROSS Crociera	FEET Piedino	GOLD LACQUERED Laccato oro	BRUSHED S/STEEL Inox satinato	POLISHED S/STEEL Inox lucido	CORTEN Effetto Corten	ANTIQU BRASS/COPPER/BRONZE Ottone/rame/bronzo anticato
4401/VOR H500 REG			€ 299,00				
4401/AC H500 REG				€ 185,00			
4401/LU H500 REG					€ 197,00		
4401/EC H500 REG	Mod. 4006	1003 				€ 225,00	
4401/OA H500 REG							€ 299,00
4401/RM H500 REG							€ 299,00
4401/BS H500 REG							€ 299,00
4401/FX H500 REG*	Mod. 4001*			€ 245,00	€ 257,00		

PACKING / Imballo

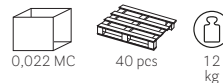

TECHNICAL DETAILS / Dettagli tecnici
TOP MAX



Inox



CODE Codice	CROSS Crociera	FEET Piedino	BLACK POWDER COATED Verniciato nero	POWDER COATED Verniciato	BRUSHED S/STEEL Inox satinato	POLISHED S/STEEL Inox lucido	CORTEN Effetto Corten	ANTIQU BRASS/COPPER/BRONZE Ottone/rame/bronzo anticato
4404*			€ 169,00	€ 180,00				
4404/AC		1001 			€ 219,00			
4404/LU						€ 255,00		
4404/EC							€ 260,00	
4404/OA								€ 350,00
4404/RM								€ 350,00
4404/BS	Mod. 4000							€ 350,00
4404/AC REG		1003 			€ 228,00			
4404/LU REG						€ 263,00		
4404/EC REG							€ 270,00	
4404/OA REG								€ 359,00
4404/RM REG								€ 359,00
4404/BS REG								€ 359,00

PACKING / Imballo



TECHNICAL DETAILS / Dettagli tecnici
TOP MAX



Inox



CODE Codice	CROSS Crociera	FEET Piedino	BLACK POWDER COATED Verniciato nero	POWDER COATED Verniciato	BRUSHED S/STEEL Inox satinato	POLISHED S/STEEL Inox lucido	CORTEN Effetto Corten	ANTIQU BRASS/COPPER/BRONZE Ottone/rame/bronzo anticato
4402*			€ 155,00	€ 166,00				
4402/AC		1001 			€ 211,00			
4402/LU						€ 240,00		
4402/EC	Mod. 4015						€ 250,00	
4402/OA								€ 325,00
4402/RM								€ 325,00
4402/BS								€ 325,00

PACKING / Imballo



TECHNICAL DETAILS / Dettagli tecnici
TOP MAX



Inox



CODE Codice	CROSS Crociera	FEET Piedino	BRUSHED S/STEEL Inox satinato	POLISHED S/STEEL Inox lucido	CORTEN Effetto Corten	ANTIQUE BRASS/COPPER/BRONZE Ottone/rame/bronzo anticato
4402/AC REG			€ 219,00			
4402/LU REG				€ 249,00		
4402/EC REG	Mod. 4015	1003 			€ 258,00	
4402/OA REG						€ 333,00
4402/RM REG						€ 333,00
4402/BS REG						€ 333,00

PACKING / Imballo

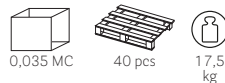
TECHNICAL DETAILS / Dettagli tecnici
TOP MAX

Inox



CODE Codice	CROSS Crociera	FEET Piedino	BLACK POWDER COATED Verniciato nero	POWDER COATED Verniciato	BRUSHED S/STEEL Inox satinato	POLISHED S/STEEL Inox lucido	ANTIQUE BRASS/COPPER/BRONZE Ottone/rame/bronzo anticato
4402/RV	Mod. 4015	1001 	€ 276,00	€ 286,00	€ 306,00	€ 327,00	€ 393,00
4402/RV REG		1003 			€ 314,00	€ 335,00	€ 402,00

PACKING / Imballo

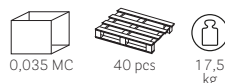
TECHNICAL DETAILS / Dettagli tecnici
TOP MAX

Inox



CODE Codice	CROSS Crociera	FEET Piedino	BLACK POWDER COATED Verniciato nero	POWDER COATED Verniciato	BRUSHED S/STEEL Inox satinato	POLISHED S/STEEL Inox lucido	CORTEN Effetto Corten	ANTIQUE BRASS/COPPER/BRONZE Ottone/rame/bronzo anticato
4402 H500	Mod. 4006	1001 	€ 155,00	€ 166,00	€ 211,00	€ 240,00	€ 250,00	€ 325,00
4402/AC H500								
4402/LU H500								
4402/EC H500		1003 			€ 219,00	€ 249,00	€ 258,00	€ 333,00
4402/OA H500								
4402/RM H500								
4402/BS H500								

PACKING / Imballo

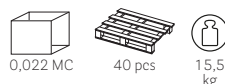
TECHNICAL DETAILS / Dettagli tecnici
TOP MAX

Inox

Adjustable in height with gas lift device
Regolabile in altezza con meccanismo di alzata a gas



CODE Codice	CROSS Crociera	FEET Piedino	SATINIZED Satinato
4402H/ST	Mod. 4001	1001 	€ 494,00
4402H/ST REG		1003 	€ 501,00

PACKING / Imballo

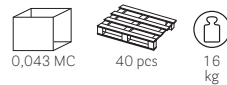

TECHNICAL DETAILS / Dettagli tecnici
TOP MAX



Inox



CODE Codice	CROSS Crociera	FEET Piedino	BLACK POWDER COATED Verniciato nero	POWDER COATED Verniciato	BRUSHED S/STEEL Inox satinato	CORTEN Effetto Corten	ANTIQUÉ BRASS/COPPER/BRONZE Ottone/rame/bronzo anticato
4406* 4406/AC 4406/EC 4406/OA 4406/RM 4406/BS	Mod. 4015	1001 	€ 182,00	€ 193,00	€ 272,00	€ 312,00	€ 411,00 € 411,00 € 411,00
4406/AC REG 4406/EC REG 4406/OA REG 4406/RM REG 4406/BS REG		1003 			€ 281,00	€ 320,00	€ 420,00 € 420,00 € 420,00

PACKING / Imballo



TECHNICAL DETAILS / Dettagli tecnici
TOP MAX



Inox

Adjustable in height with gas lift device
Regolabile in altezza con meccanismo di alzata a gas



CODE Codice	CROSS Crociera	FEET Piedino	SATINIZED Satinato
4406H/ST	Mod. 4001	1001 	€ 465,00
4406H/ST REG		1003 	€ 471,00

PACKING / Imballo

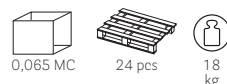

TECHNICAL DETAILS / Dettagli tecnici
TOP MAX



Inox



CODE Codice	CROSS Crociera	FEET Piedino	BLACK POWDER COATED Verniciato nero	POWDER COATED Verniciato	GOLD LACQUERED Laccato oro	BRUSHED S/STEEL Inox satinato	POLISHED S/STEEL Inox lucido
4410*			€ 160,00	€ 171,00			
4411/VOR		1001 			€ 323,00		
4411/AC						€ 223,00	
4411/LU	Mod. 4000						€ 258,00
4411/VOR REG		1003 			€ 332,00		
4411/AC REG						€ 232,00	
4411/LU REG							€ 267,00

PACKING / Imballo



TECHNICAL DETAILS / Dettagli tecnici
TOP MAX



Inox



CODE Codice	CROSS Crociera	FEET Piedino	BLACK POWDER COATED Verniciato nero	POWDER COATED Verniciato	BRUSHED S/STEEL Inox satinato	POLISHED S/STEEL Inox lucido
4410/RV*		1001 	€ 281,00	€ 292,00		
4411/RV					€ 318,00	€ 344,00
4411/RV REG	Mod. 4000	1003 			€ 327,00	€ 353,00

PACKING / Imballo



TECHNICAL DETAILS / Dettagli tecnici
TOP MAX



Inox



CODE Codice	CROSS Crociera	FEET Piedino	BRUSHED S/STEEL Inox satinato	POLISHED S/STEEL Inox lucido
4411/FX		1001 	€ 283,00	€ 318,00
4411/FX REG	Mod. 4008	1003 	€ 290,00	€ 327,00

PACKING / Imballo

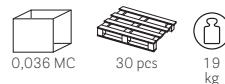

TECHNICAL DETAILS / Dettagli tecnici
TOP MAX



Inox



CODE Codice	CROSS Crociera	FEET Piedino	BLACK POWDER COATED Verniciato nero	POWDER COATED Verniciato	GOLD LACQUERED Laccato oro	BRUSHED S/STEEL Inox satinato	POLISHED S/STEEL Inox lucido
4413			€ 160,00	€ 171,00			
4413/VOR	Mod. 4001	1001			€ 323,00		
4413/AC						€ 223,00	
4413/LU							€ 258,00
4413/FX*						€ 283,00	€ 299,00
4413/VOR REG	Mod. 4001	1003			€ 332,00		
4413/AC REG						€ 232,00	
4413/LU REG							€ 267,00
4413/FX REG*						€ 290,00	€ 307,00

PACKING / Imballo

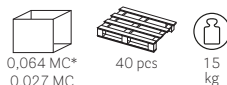

TECHNICAL DETAILS / Dettagli tecnici
TOP MAX



Inox



CODE Codice	CROSS Crociera	FEET Piedino	BLACK POWDER COATED Verniciato nero	POWDER COATED Verniciato	BRUSHED S/STEEL Inox satinato	POLISHED S/STEEL Inox lucido	CORTEN Effetto Corten	ANTIQUÉ BRASS/COPPER/BRONZE Ottone/rame/bronzo anticato
4412*			€ 146,00	€ 156,00				
4412/AC	Mod. 4000	1001			€ 188,00			
4412/LU						€ 224,00		
4412/EC							€ 214,00	
4412/OA								€ 303,00
4412/RM								€ 303,00
4412/BS								€ 303,00
4412/AC REG	Mod. 4000	1003			€ 197,00			
4412/LU REG						€ 232,00		
4412/EC REG							€ 223,00	
4412/OA REG								€ 312,00
4412/RM REG								€ 312,00
4412/BS REG								€ 312,00

PACKING / Imballo



TECHNICAL DETAILS / Dettagli tecnici
TOP MAX



Inox



CODE Codice	CROSS Crociera	FEET Piedino	BLACK POWDER COATED Verniciato nero	POWDER COATED Verniciato	BRUSHED S/STEEL Inox satinato	POLISHED S/STEEL Inox lucido	CORTEN Effetto Corten	ANTIQUÉ BRASS/COPPER/BRONZE Ottone/rame/bronzo anticato
4412 H500*			€ 155,00	€ 164,00				
4412/AC H500	Mod. 4006	1001			€ 197,00			
4412/LU H500						€ 232,00		
4412/EC H500							€ 223,00	
4412/OA H500								€ 312,00
4412/RM H500								€ 312,00
4412/BS H500								€ 312,00
4412/AC H500 REG	Mod. 4006	1003			€ 205,00			
4412/LU H500 REG						€ 241,00		
4412/EC H500 REG							€ 232,00	
4412/OA H500 REG								€ 320,00
4412/RM H500 REG								€ 320,00
4412/BS H500 REG								€ 320,00

PACKING / Imballo



TECHNICAL DETAILS / Dettagli tecnici
TOP MAX



Inox



CODE Codice	CROSS Crociera	FEET Piedino	BLACK POWDER COATED Verniciato nero	POWDER COATED Verniciato	BRUSHED S/STEEL Inox satinato	POLISHED S/STEEL Inox lucido
4414			€ 192,00	€ 202,00		
4414/AC	Mod. 4000	1001 			€ 270,00	
4414/LU						€ 305,00
4414/FX*	Mod. 4008*				€ 329,00	€ 364,00
4414/AC REG	Mod. 4000	1003 			€ 279,00	
4414/LU REG						€ 314,00
4414/FX REG*	Mod. 4008*				€ 338,00	€ 374,00

PACKING / Imballo

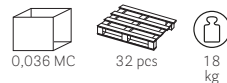

TECHNICAL DETAILS / Dettagli tecnici
TOP MAX



Inox



CODE Codice	CROSS Crociera	FEET Piedino	CHROMED Cromato	BRUSHED S/STEEL Inox satinato
4414R/AC		1001 		€ 428,00
4414R/CR			€ 428,00	
4414R/AC REG	Mod. 4000	1003 		€ 436,00
4414R/CR REG			€ 436,00	

PACKING / Imballo

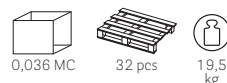

TECHNICAL DETAILS / Dettagli tecnici
TOP MAX



Inox



CODE Codice	CROSS Crociera	FEET Piedino	BLACK POWDER COATED Verniciato nero	POWDER COATED Verniciato	BRUSHED S/STEEL Inox satinato	POLISHED S/STEEL Inox lucido
4420*			€ 164,00	€ 175,00		
4421/AC	Mod. 4000	1001 			€ 232,00	
4421/LU						€ 257,00
4421/AC 316	Mod. 4000NY				€ 368,00	
4421/AC REG	Mod. 4000	1003 			€ 241,00	
4421/LU REG						€ 266,00
4421/AC 316 REG	Mod. 4000NY				€ 376,00	

PACKING / Imballo



TECHNICAL DETAILS / Dettagli tecnici
TOP MAX



Inox



CODE Codice	CROSS Crociera	FEET Piedino	BLACK POWDER COATED Verniciato nero	POWDER COATED Verniciato	BRUSHED S/STEEL Inox satinato	POLISHED S/STEEL Inox lucido
4420/RV*	Mod. 4000	1001 	€ 285,00	€ 296,00		
4421/RV					€ 327,00	€ 353,00
4421/RV REG		1003 				€ 336,00

PACKING / Imballo



TECHNICAL DETAILS / Dettagli tecnici
TOP MAX



Inox



CODE Codice	CROSS Crociera	FEET Piedino	BRUSHED S/STEEL Inox satinato	POLISHED S/STEEL Inox lucido
4421/FX	Mod. 4008	1001 	€ 292,00	€ 298,00
4421/FX REG		1003 	€ 299,00	€ 307,00

PACKING / Imballo

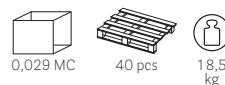

TECHNICAL DETAILS / Dettagli tecnici
TOP MAX



Inox



CODE Codice	CROSS Crociera	FEET Piedino	BLACK POWDER COATED Verniciato nero	POWDER COATED Verniciato	BRUSHED S/STEEL Inox satinato	POLISHED S/STEEL Inox lucido	
4423**	Mod. 4001	1001 	€ 164,00	€ 175,00			
4423/AC					€ 232,00		
4423/AC 316					€ 368,00		
4423/LU						€ 257,00	
4423/FX*					€ 292,00	€ 298,00	
4423/AC REG		1003 				€ 241,00	
4423/AC 316 REG						€ 376,00	
4423/LU REG						€ 266,00	
4423/FX REG*					€ 299,00	€ 307,00	

PACKING / Imballo



TECHNICAL DETAILS / Dettagli tecnici
TOP MAX



Inox



CODE Codice	CROSS Crociera	FEET Piedino	BLACK POWDER COATED Verniciato nero	POWDER COATED Verniciato	BRUSHED S/STEEL Inox satinato	POLISHED S/STEEL Inox lucido
4424	Mod. 4000	1001	€ 195,00	€ 206,00		
4424/AC					€ 279,00	
4424/LU						€ 305,00
4424/AC REG		1003			€ 288,00	
4424/LU REG						€ 312,00

PACKING / Imballo

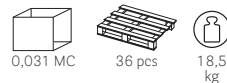

TECHNICAL DETAILS / Dettagli tecnici
TOP MAX



Inox



CODE Codice	CROSS Crociera	FEET Piedino	BRUSHED S/STEEL Inox satinato	POLISHED S/STEEL Inox lucido
4424/FX	Mod. 4008	1001	€ 338,00	€ 329,00
4424/FX REG		1003	€ 348,00	€ 338,00

PACKING / Imballo

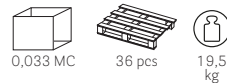

TECHNICAL DETAILS / Dettagli tecnici
TOP MAX



Inox



CODE Codice	CROSS Crociera	FEET Piedino	BLACK POWDER COATED Verniciato nero	POWDER COATED Verniciato	BRUSHED S/STEEL Inox satinato	POLISHED S/STEEL Inox lucido	CORTEN Effetto Corten	ANTIQUE BRASS/COPPER/BRONZE Ottone/rame/bronzo anticato	
4430 REG*	Mod. 4008	1006	€ 225,00	€ 234,00					
4431/AC REG					€ 320,00				
4431/LU REG							€ 368,00		
4431/EC REG								€ 367,00	
4431/OA REG									€ 454,00
4431/BS REG									€ 454,00
4431/RM REG									€ 454,00

PACKING / Imballo



TECHNICAL DETAILS / Dettagli tecnici
TOP MAX



For colours and finishes see at page 280
Per colori e finiture vedere da pagina 280

Inox



CODE Codice	CROSS Crociera	FEET Piedino	BLACK POWDER COATED Verniciato nero	POWDER COATED Verniciato	BRUSHED S/STEEL Inox satinato	POLISHED S/STEEL Inox lucido	ANTIQUE BRASS/COPPER/BRONZE Ottone/rame/bronzo anticato
4430/RV REG*	Mod. 4008	1006 	€ 336,00	€ 345,00			
4431/RV REG					€ 406,00	€ 455,00	€ 533,00

PACKING / Imballo



TECHNICAL DETAILS / Dettagli tecnici
TOP MAX



Inox



CODE Codice	CROSS Crociera	FEET Piedino	BRUSHED S/STEEL Inox satinato	POLISHED S/STEEL Inox lucido
4431/FX REG	Mod. 4008	1006 	€ 375,00	€ 423,00

PACKING / Imballo

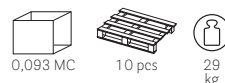

TECHNICAL DETAILS / Dettagli tecnici
TOP MAX



Inox



CODE Codice	CROSS Crociera	FEET Piedino	BLACK POWDER COATED Verniciato nero	POWDER COATED Verniciato	BRUSHED S/STEEL Inox satinato	POLISHED S/STEEL Inox lucido	CORTEN Effetto Corten	ANTIQUE BRASS/COPPER/BRONZE Ottone/rame/bronzo anticato	
4433 REG	Mod. 4008	1006 	€ 225,00	€ 234,00					
4433/AC REG						€ 320,00			
4433/LU REG							€ 368,00		
4433/EC REG								€ 367,00	
4433/OA REG									€ 454,00
4433/RM REG									€ 454,00
4433/BS REG							€ 454,00		
4433/FX REG*	Mod. 4001*				€ 375,00	€ 423,00			

PACKING / Imballo

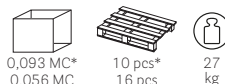

TECHNICAL DETAILS / Dettagli tecnici
TOP MAX



Inox



CODE Codice	CROSS Crociera	FEET Piedino	BLACK POWDER COATED Verniciato nero	POWDER COATED Verniciato	BRUSHED S/STEEL Inox satinato	POLISHED S/STEEL Inox lucido	CORTEN Effetto Corten	ANTIQUE BRASS/COPPER/BRONZE Ottone/rame/bronzo anticato
4434 REG*			€ 254,00	€ 263,00				
4434/AC REG					€ 363,00			
4434/LU REG		1006				€ 411,00		
4434/EC REG	Mod. 4008						€ 410,00	
4434/OA REG								€ 497,00
4434/RM REG								€ 497,00
4434/BS REG								€ 497,00

PACKING / Imballo



TECHNICAL DETAILS / Dettagli tecnici
TOP MAX



Inox



CODE Codice	CROSS Crociera	FEET Piedino	BRUSHED S/STEEL Inox satinato	POLISHED S/STEEL Inox lucido
4434/FX REG	Mod. 4008	1006 	€ 406,00	€ 454,00

PACKING / Imballo

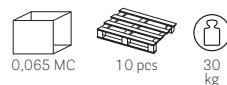

TECHNICAL DETAILS / Dettagli tecnici
TOP MAX



Inox



CODE Codice	CROSS Crociera	FEET Piedino	BRUSHED S/STEEL Inox satinato
4437/AC REG	Mod. 4437.10	1003 	€ 916,00

PACKING / Imballo



TECHNICAL DETAILS / Dettagli tecnici
TOP MAX



HPL = Solid laminate tops / Ripiani in stratificato
LAM = Laminate tops / Ripiani in laminato
Steel base / Base in lamiera

For colours and finishes see at page 280
Per colori e finiture vedere da pagina 280

Inox





CODE Codice	CROSS Crociera	FEET Piedino	BLACK POWDER COATED Verniciato nero	POWDER COATED Verniciato	BRUSHED S/STEEL Inox satinato	POLISHED S/STEEL Inox lucido
4440*		1001	€ 181,00	€ 192,00		
4441/AC	Mod. 4000				€ 249,00	
4441/LU						€ 275,00
4441/AC REG		1003			€ 257,00	
4441/LU REG						€ 284,00

PACKING / Imballo

TECHNICAL DETAILS / Dettagli tecnici
TOP MAX

Inox



CODE Codice	CROSS Crociera	FEET Piedino	BRUSHED S/STEEL Inox satinato	POLISHED S/STEEL Inox lucido
4441/FX		1001	€ 327,00	€ 354,00
	Mod. 4008			
4441/FX REG		1003	€ 336,00	€ 362,00
				

PACKING / Imballo

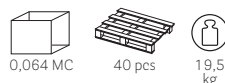
TECHNICAL DETAILS / Dettagli tecnici
TOP MAX

Inox



CODE Codice	CROSS Crociera	FEET Piedino	STAINLESS STEEL COVER-BASE, ANODIZED ALUMINIUM COLUMN Copribase in acciaio inox, colonna in alluminio anodizzato
4441/AS		1001	€ 229,00
	Mod. 4000		
4441/AS REG		1003	€ 238,00
			

PACKING / Imballo

TECHNICAL DETAILS / Dettagli tecnici
TOP MAX

Inox



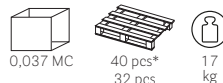

CODE Codice	CROSS Crociera	FEET Piedino	BLACK POWDER COATED Verniciato nero	POWDER COATED Verniciato	BRUSHED S/STEEL Inox satinato	POLISHED S/STEEL Inox lucido
4443	Mod. 4000	1001 	€ 181,00	€ 192,00		
4443/AC					€ 249,00	
4443/LU						
4443/FX*	Mod. 4008*				€ 327,00	€ 354,00
4443/AC REG	Mod. 4000	1003 			€ 257,00	
4443/LU REG						€ 284,00
4443/FX REG*			Mod. 4008*			€ 336,00

PACKING / Imballo

TECHNICAL DETAILS / Dettagli tecnici
TOP MAX

Inox



CODE Codice	CROSS Crociera	FEET Piedino	BLACK POWDER COATED Verniciato nero	POWDER COATED Verniciato	BRUSHED S/STEEL Inox satinato	POLISHED S/STEEL Inox lucido
4444	Mod. 4000	1001 	€ 220,00	€ 231,00		
4444/AC					€ 327,00	
4444/LU						
4444/AC REG	Mod. 4000	1003 			€ 336,00	
4444/LU REG						€ 362,00

PACKING / Imballo

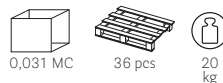
TECHNICAL DETAILS / Dettagli tecnici
TOP MAX

Inox



CODE Codice	CROSS Crociera	FEET Piedino	STAINLESS STEEL COVER-BASE, ANODIZED ALUMINIUM COLUMN Copribase in acciaio inox, colonna in alluminio anodizzato			
4444/AS	Mod. 4000	1001 			€ 296,00	
4444/AS REG		1003 			€ 305,00	

PACKING / Imballo

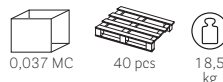
TECHNICAL DETAILS / Dettagli tecnici
TOP MAX

Inox



CODE Codice	CROSS Crociera	FEET Piedino	BLACK POWDER COATED Verniciato nero	POWDER COATED Verniciato	BRUSHED S/STEEL Inox satinato	POLISHED S/STEEL Inox lucido
4452*	Mod. 4008	1001	€ 281,00	€ 290,00	€ 379,00	€ 394,00
4452/AC						
4452/LU						
4452/AC REG		1003			€ 388,00	€ 403,00
4452/LU REG						

PACKING / Imballo



TECHNICAL DETAILS / Dettagli tecnici



Inox



CODE Codice	CROSS Crociera	FEET Piedino	BLACK POWDER COATED Verniciato nero	POWDER COATED Verniciato	BRUSHED S/STEEL Inox satinato	POLISHED S/STEEL Inox lucido
4452 H500*	Mod. 4008	1001	€ 281,00	€ 290,00	€ 379,00	€ 394,00
4452/AC H500						
4452/LU H500						
4452/AC H500 REG		1003			€ 388,00	€ 403,00
4452/LU H500 REG						

PACKING / Imballo



TECHNICAL DETAILS / Dettagli tecnici

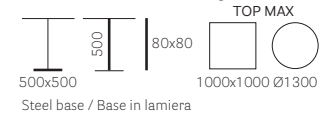

Inox



CODE Codice	CROSS Crociera	FEET Piedino	BLACK POWDER COATED Verniciato nero	POWDER COATED Verniciato	BRUSHED S/STEEL Inox satinato	POLISHED S/STEEL Inox lucido
4456*	Mod. 4008	1001	€ 320,00	€ 329,00	€ 457,00	€ 472,00
4456/AC						
4456/LU						
4456/AC REG		1003			€ 467,00	€ 483,00
4456/LU REG						

PACKING / Imballo



TECHNICAL DETAILS / Dettagli tecnici



Inox



CODE Codice	CROSS Crociera	FEET Piedino	BLACK POWDER COATED Verniciato nero	POWDER COATED Verniciato	BRUSHED S/STEEL Inox satinato	POLISHED S/STEEL Inox lucido
4460*	2xMod. 4000	1001	€ 280,00	€ 289,00		
4461/AC					€ 372,00	
4461/LU						€ 403,00
4461/AC REG		1006			€ 381,00	
4461/LU REG						€ 411,00

PACKING / Imballo



TECHNICAL DETAILS / Dettagli tecnici
TOP MAX

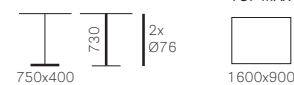

Inox



CODE Codice	CROSS Crociera	FEET Piedino	BLACK POWDER COATED Verniciato nero	POWDER COATED Verniciato	BRUSHED S/STEEL Inox satinato	POLISHED S/STEEL Inox lucido
4460/RV*	2xMod. 4000	1001	€ 500,00	€ 510,00		
4461/RV					€ 546,00	€ 561,00
4461/RV REG		1006			€ 554,00	€ 569,00

PACKING / Imballo

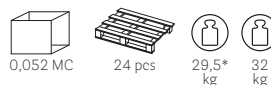

TECHNICAL DETAILS / Dettagli tecnici
TOP MAX



Inox



CODE Codice	CROSS Crociera	FEET Piedino	BRUSHED S/STEEL Inox satinato	POLISHED S/STEEL Inox lucido
4461/FX	2xMod. 4008	1001	€ 481,00	€ 511,00
4461/FX REG		1006	€ 489,00	€ 519,00

PACKING / Imballo



TECHNICAL DETAILS / Dettagli tecnici
TOP MAX



Inox

CODE Codice	CROSS Crociera	FEET Piedino	BLACK POWDER COATED Verniciato nero	POWDER COATED Verniciato	BRUSHED S/STEEL Inox satinato	POLISHED S/STEEL Inox lucido
4463	2xMod. 4000	1001 	€ 280,00	€ 289,00		
4463/AC					€ 372,00	
4463/LU						
4463/FX*	2xMod. 4001*				€ 481,00	€ 511,00
4463/AC REG	2xMod. 4000	1006 			€ 381,00	
4463/LU REG						€ 411,00
4463/FX REG*			2xMod. 4001*			€ 489,00



PACKING / Imballo

 0,089 MC*
0,051 MC

 12 pcs*
24 pcs

 28
kg
(4463)

 30,5
kg

 35*
kg

TECHNICAL DETAILS / Dettagli tecnici
TOP MAX



 750x400

 500

 2x
Ø76/90*

 1600x900

Inox

CODE Codice	CROSS Crociera	FEET Piedino	BLACK POWDER COATED Verniciato nero	POWDER COATED Verniciato	BRUSHED S/STEEL Inox satinato	POLISHED S/STEEL Inox lucido
4462*	2xMod. 4000	1001 	€ 297,00	€ 306,00		
4462/AC					€ 405,00	
4462/LU						
4462/AC REG	2xMod. 4000	1006 			€ 413,00	
4462/LU REG						€ 440,00



PACKING / Imballo

 0,051 MC

 24 pcs

 32*
kg

 35
kg

TECHNICAL DETAILS / Dettagli tecnici
TOP MAX



 750x400

 730

 2x
80x80

 1600x900

Inox

CODE Codice	CROSS Crociera	FEET Piedino	BRUSHED S/STEEL Inox satinato	POLISHED S/STEEL Inox lucido
4462/FX	2xMod. 4008	1001 	€ 548,00	€ 575,00
4462/FX REG		1006 	€ 556,00	€ 583,00



PACKING / Imballo

 0,065 MC

 12 pcs

 37,5
kg

TECHNICAL DETAILS / Dettagli tecnici
TOP MAX

 750x400



 730

 2x
80x80

 1600x900

Inox



CODE Codice	CROSS Crociera	FEET Piedino	STAINLESS STEEL COVER-BASE, ANODIZED ALUMINIUM COLUMN Copribase in acciaio inox, colonna in alluminio anodizzato			
4462/AS	2xMod. 4000	1001 	€ 370,00			
4462/AS REG		1006 				

PACKING / Imballo

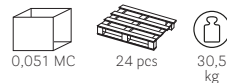
TECHNICAL DETAILS / Dettagli tecnici
TOP MAX

Inox





CODE Codice	CROSS Crociera	FEET Piedino	BLACK POWDER COATED Verniciato nero	POWDER COATED Verniciato	BRUSHED S/STEEL Inox satinato	POLISHED S/STEEL Inox lucido
4462/RV	2xMod. 4015	1001 	€ 518,00	€ 527,00	€ 578,00	€ 589,00
4462/RV REG		1006 			€ 585,00	€ 597,00

PACKING / Imballo

TECHNICAL DETAILS / Dettagli tecnici
TOP MAX

Inox



CODE Codice	CROSS Crociera	FEET Piedino	BLACK POWDER COATED Verniciato nero	POWDER COATED Verniciato	BRUSHED S/STEEL Inox satinato	POLISHED S/STEEL Inox lucido
4462 H500	2xMod. 4000	1001 	€ 297,00	€ 306,00	€ 405,00	€ 432,00
4462/AC H500						
4462/LU H500						
4462/FX H500*	2xMod. 4008*	1006 			€ 548,00	€ 575,00
4462/AC H500 REG	2xMod. 4000				€ 413,00	€ 440,00
4462/LU H500 REG						€ 440,00
4462/FX H500 REG*	2xMod. 4008*				€ 556,00	€ 583,00

PACKING / Imballo

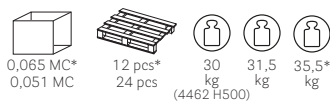
TECHNICAL DETAILS / Dettagli tecnici
TOP MAX

Inox



CODE Codice	CROSS Crociera	FEET Piedino	BLACK POWDER COATED Verniciato nero	POWDER COATED Verniciato	BRUSHED S/STEEL Inox satinato	POLISHED S/STEEL Inox lucido
4464*	2xMod. 4000	1001	€ 337,00	€ 346,00		
4464/AC					€ 458,00	
4464/LU						€ 489,00
4464/AC REG		1006			€ 467,00	
4464/LU REG						€ 497,00

PACKING / Imballo

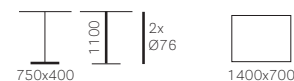
TECHNICAL DETAILS / Dettagli tecnici
TOP MAX

Inox



CODE Codice	CROSS Crociera	FEET Piedino	BRUSHED S/STEEL Inox satinato	POLISHED S/STEEL Inox lucido
4464/FX	2xMod. 4008	1001	€ 544,00	€ 575,00
4464/FX REG		1006	€ 553,00	€ 583,00

PACKING / Imballo

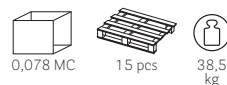
TECHNICAL DETAILS / Dettagli tecnici
TOP MAX

Inox



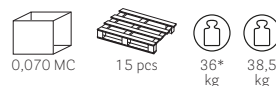

CODE Codice	CROSS Crociera	FEET Piedino	BLACK POWDER COATED Verniciato nero	POWDER COATED Verniciato	BRUSHED S/STEEL Inox satinato	POLISHED S/STEEL Inox lucido
4466*	2xMod. 4000	1001	€ 368,00	€ 377,00		
4466/AC					€ 548,00	
4466/LU						€ 575,00
4466/AC REG		1006			€ 556,00	
4466/LU REG						€ 583,00

PACKING / Imballo

TECHNICAL DETAILS / Dettagli tecnici
TOP MAX

Inox



CODE Codice	CROSS Crociera	FEET Piedino	STAINLESS STEEL COVER-BASE, ANODIZED ALUMINIUM COLUMN Copribase in acciaio inox, colonna in alluminio anodizzato			
4466/AS	2xMod. 4000	1001 	€ 491,00			
4466/AS REG		1006 				

PACKING / Imballo

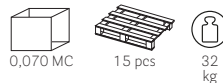
TECHNICAL DETAILS / Dettagli tecnici
TOP MAX

Inox





CODE Codice	CROSS Crociera	FEET Piedino	BLACK POWDER COATED Verniciato nero	POWDER COATED Verniciato	BRUSHED S/STEEL Inox satinato	POLISHED S/STEEL Inox lucido
4467*	2xMod. 4015	1001 	€ 277,00	€ 286,00	€ 358,00	€ 385,00
4467/AC						
4467/LU						
4467/AC REG	2xMod. 4015	1006 			€ 367,00	
4467/LU REG					€ 393,00	

PACKING / Imballo

TECHNICAL DETAILS / Dettagli tecnici
TOP MAX

Inox



CODE Codice	CROSS Crociera	FEET Piedino	BLACK POWDER COATED Verniciato nero	POWDER COATED Verniciato	BRUSHED S/STEEL Inox satinato	POLISHED S/STEEL Inox lucido
4467 H500*	2xMod. 4015	1001 	€ 277,00	€ 286,00	€ 358,00	€ 385,00
4467/AC H500						
4467/LU H500						
4467/AC H500 REG	2xMod. 4015	1006 			€ 367,00	
4467/LU H500 REG					€ 393,00	

PACKING / Imballo

TECHNICAL DETAILS / Dettagli tecnici
TOP MAX

Inox



CODE Codice	CROSS Crociera	FEET Piedino	BLACK POWDER COATED Verniciato nero	POWDER COATED Verniciato	BRUSHED S/STEEL Inox satinato	POLISHED S/STEEL Inox lucido
4470 REG*			€ 221,00	€ 231,00		
4471/AC REG	Mod. 4008	1006 			€ 296,00	
4471/LU REG						€ 329,00

PACKING / Imballo

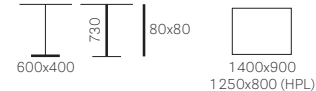
TECHNICAL DETAILS / Dettagli tecnici
TOP MAX

HPL = Solid laminate tops / Ripiani in stratificato

Inox



CODE Codice	CROSS Crociera	FEET Piedino	BRUSHED S/STEEL Inox satinato	POLISHED S/STEEL Inox lucido
4471/FX REG	Mod. 4008	1006 	€ 367,00	€ 401,00

PACKING / Imballo

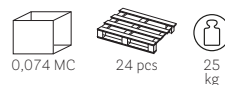
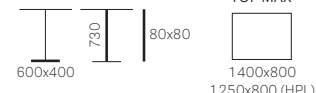
TECHNICAL DETAILS / Dettagli tecnici
TOP MAX

HPL = Solid laminate tops / Ripiani in stratificato

Inox



CODE Codice	CROSS Crociera	FEET Piedino	BLACK POWDER COATED Verniciato nero	POWDER COATED Verniciato	BRUSHED S/STEEL Inox satinato	POLISHED S/STEEL Inox lucido
4473 REG*			€ 221,00	€ 231,00		
4473/AC REG	Mod. 4008	1006 			€ 296,00	
4473/LU REG						€ 329,00

PACKING / Imballo

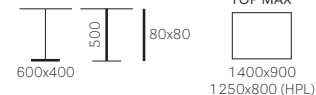
TECHNICAL DETAILS / Dettagli tecnici
TOP MAX

HPL = Solid laminate tops / Ripiani in stratificato

Inox



CODE Codice	CROSS Crociera	FEET Piedino	BLACK POWDER COATED Verniciato nero	POWDER COATED Verniciato	BRUSHED S/STEEL Inox satinato	POLISHED S/STEEL Inox lucido
4472 REG*			€ 225,00	€ 234,00		
4472/AC REG	Mod. 4008	1006 			€ 301,00	
4472/LU REG						€ 338,00

PACKING / Imballo



0,037 MC



32 pcs



20*

24,5
kgTECHNICAL DETAILS / Dettagli tecnici
TOP MAX

600x400



730



Ø76



1200x800

Inox



CODE Codice	CROSS Crociera	FEET Piedino	BLACK POWDER COATED Verniciato nero	POWDER COATED Verniciato	BRUSHED S/STEEL Inox satinato	POLISHED S/STEEL Inox lucido
4472/RV REG	Mod. 4008	1006 	€ 336,00	€ 345,00	€ 388,00	€ 418,00

PACKING / Imballo



0,037 MC



32 pcs

24,5
kgTECHNICAL DETAILS / Dettagli tecnici
TOP MAX

600x400



730



Ø76



1200x800

Inox



CODE Codice	CROSS Crociera	FEET Piedino	BLACK POWDER COATED Verniciato nero	POWDER COATED Verniciato	BRUSHED S/STEEL Inox satinato	POLISHED S/STEEL Inox lucido
4472 H500 REG*			€ 225,00	€ 234,00		
4472/AC H500 REG	Mod. 4008	1006 			€ 301,00	
4472/LU H500 REG						€ 338,00

PACKING / Imballo



0,037 MC



32 pcs



19,5*

21,5
kgTECHNICAL DETAILS / Dettagli tecnici
TOP MAX

600x400



500



Ø76



1200x800

Inox



CODE Codice	CROSS Crociera	FEET Piedino	BLACK POWDER COATED Verniciato nero	POWDER COATED Verniciato	BRUSHED S/STEEL Inox satinato	POLISHED S/STEEL Inox lucido
4474 REG*			€ 257,00	€ 267,00		
4474/AC REG	Mod. 4008	1006 			€ 367,00	
4474/LU REG						€ 401,00

PACKING / Imballo

TECHNICAL DETAILS / Dettagli tecnici
TOP MAX

Inox



CODE Codice	CROSS Crociera	FEET Piedino	BLACK POWDER COATED Verniciato nero	POWDER COATED Verniciato	BRUSHED S/STEEL Inox satinato	POLISHED S/STEEL Inox lucido
4475 REG*			€ 207,00	€ 216,00		
4475/AC REG	Mod. 4015	1006 			€ 272,00	
4475/LU REG						€ 293,00

PACKING / Imballo

TECHNICAL DETAILS / Dettagli tecnici
TOP MAX

Inox



CODE Codice	CROSS Crociera	FEET Piedino	BLACK POWDER COATED Verniciato nero	POWDER COATED Verniciato	BRUSHED S/STEEL Inox satinato	POLISHED S/STEEL Inox lucido
4475/RV REG	Mod. 4015	1006 	€ 318,00	€ 327,00	€ 359,00	€ 371,00

PACKING / Imballo

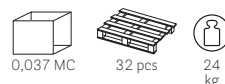
TECHNICAL DETAILS / Dettagli tecnici
TOP MAX

Inox



CODE Codice	CROSS Crociera	FEET Piedino	BLACK POWDER COATED Verniciato nero	POWDER COATED Verniciato	BRUSHED S/STEEL Inox satinato	POLISHED S/STEEL Inox lucido
4475 H500 REG*			€ 207,00	€ 216,00		
4475/AC H500 REG	Mod. 4015	1006 			€ 272,00	
4475/LU H500 REG						€ 293,00

PACKING / Imballo



TECHNICAL DETAILS / Dettagli tecnici
TOP MAX



Inox



CODE Codice	CROSS Crociera	FEET Piedino	BRUSHED S/STEEL Inox satinato	POLISHED S/STEEL Inox lucido
4481/FM		1001 	€ 314,00	€ 333,00
4481/FM REG	Mod. 4008	1003 	€ 322,00	€ 341,00

PACKING / Imballo

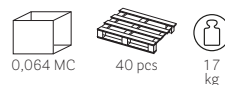

TECHNICAL DETAILS / Dettagli tecnici
TOP MAX



Inox



CODE Codice	CROSS Crociera	FEET Piedino	BRUSHED S/STEEL Inox satinato	POLISHED S/STEEL Inox lucido
4482/FM		1001 	€ 322,00	€ 331,00
4482/FM REG	Mod. 4008	1003 	€ 329,00	€ 338,00

PACKING / Imballo

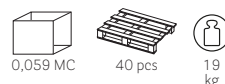

TECHNICAL DETAILS / Dettagli tecnici
TOP MAX



Inox



CODE Codice	CROSS Crociera	FEET Piedino	BLACK POWDER COATED Verniciato nero	POWDER COATED Verniciato	BRUSHED S/STEEL Inox satinato	POLISHED S/STEEL Inox lucido
4490*	Mod. 4008	1001	€ 280,00	€ 289,00	€ 364,00	€ 400,00
4491/AC						
4491/LU						
4491/AC REG	Mod. 4008	1003			€ 372,00	€ 407,00
4491/LU REG						

PACKING / Imballo



TECHNICAL DETAILS / Dettagli tecnici

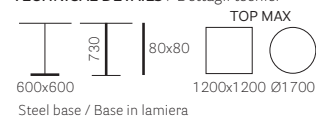

Inox



CODE Codice	CROSS Crociera	FEET Piedino	BLACK POWDER COATED Verniciato nero	POWDER COATED Verniciato	BRUSHED S/STEEL Inox satinato	POLISHED S/STEEL Inox lucido
4493*	Mod. 4008	1001	€ 280,00	€ 289,00	€ 364,00	€ 400,00
4493/AC						
4493/LU						
4493/AC REG	Mod. 4008	1003			€ 372,00	€ 407,00
4493/LU REG						

PACKING / Imballo



TECHNICAL DETAILS / Dettagli tecnici



Inox



CODE Codice	CROSS Crociera	FEET Piedino	BLACK POWDER COATED Verniciato nero	POWDER COATED Verniciato	BRUSHED S/STEEL Inox satinato	POLISHED S/STEEL Inox lucido
4492*	Mod. 4008	1001	€ 266,00	€ 275,00	€ 336,00	€ 371,00
4492/AC						
4492/LU						
4492/AC REG	Mod. 4008	1003			€ 344,00	€ 379,00
4492/LU REG						

PACKING / Imballo



TECHNICAL DETAILS / Dettagli tecnici



Inox



CODE Codice	CROSS Crociera	FEET Piedino	BLACK POWDER COATED Verniciato nero	POWDER COATED Verniciato	BRUSHED S/STEEL Inox satinato	POLISHED S/STEEL Inox lucido
4492/RV	Mod. 4008	1001 	€ 376,00	€ 385,00	€ 422,00	€ 449,00
4492/RV REG		1003 			€ 429,00	€ 457,00

PACKING / Imballo

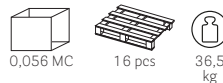



TECHNICAL DETAILS / Dettagli tecnici



Steel base / Base in lamiera

Inox



CODE Codice	CROSS Crociera	FEET Piedino	BLACK POWDER COATED Verniciato nero	POWDER COATED Verniciato	BRUSHED S/STEEL Inox satinato	POLISHED S/STEEL Inox lucido
4492 H500*	Mod. 4008	1001 	€ 266,00	€ 275,00	€ 336,00	€ 371,00
4492/AC H500						
4492/LU H500		1003 			€ 344,00	€ 379,00
4492/AC H500 REG						
4492/LU H500 REG						€ 379,00

PACKING / Imballo



TECHNICAL DETAILS / Dettagli tecnici



Steel base / Base in lamiera

Inox



CODE Codice	CROSS Crociera	FEET Piedino	BLACK POWDER COATED Verniciato nero	POWDER COATED Verniciato	BRUSHED S/STEEL Inox satinato	POLISHED S/STEEL Inox lucido
4494*	Mod. 4008	1001 	€ 315,00	€ 325,00	€ 436,00	€ 471,00
4494/AC						
4494/LU		1003 			€ 444,00	€ 479,00
4494/AC REG						
4494/LU REG						€ 479,00

PACKING / Imballo



TECHNICAL DETAILS / Dettagli tecnici



Steel base / Base in lamiera

Inox



CODE Codice	CROSS Crociera	FEET Piedino	BRUSHED S/STEEL Inox satinato	POLISHED S/STEEL Inox lucido
4497/AC REG	Mod. 4016.80	1003 	€ 578,00	€ 627,00
4497/LU REG				

PACKING / Imballo



TECHNICAL DETAILS / Dettagli tecnici

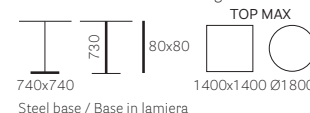

Inox



CODE Codice	CROSS Crociera	FEET Piedino	BRUSHED S/STEEL Inox satinato
4499/AC REG	Mod. 4499.10	1003 	€ 908,00

PACKING / Imballo



TECHNICAL DETAILS / Dettagli tecnici

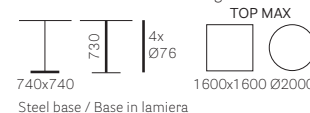

Inox



CODE Codice	CROSS Crociera	FEET Piedino	BRUSHED S/STEEL Inox satinato
4499/RV REG	Mod. 4499.10	1003 	€ 1.167,00

PACKING / Imballo



TECHNICAL DETAILS / Dettagli tecnici

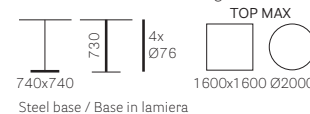

For colours and finishes see at page 280
Per colori e finiture vedere da pagina 280

Krystal



CODE Codice	CROSS Crociera	FEET Piedino	BLACK POWDER COATED Verniciato nero	BRUSHED S/STEEL Inox satinato	POLISHED S/STEEL Inox lucido
4401/KR	Mod. 4018	1001 	€ 323,00 Gold column only Solo colonna oro	€ 268,00	€ 279,00
4401/KR REG		1003 		€ 276,00	€ 286,00

METHACRYLATE FINISHES / Finiture metacrilato



PACKING / Imballo

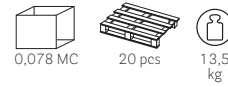

TECHNICAL DETAILS / Dettagli tecnici



Krystal



CODE Codice	CROSS Crociera	FEET Piedino	BLACK POWDER COATED Verniciato nero	BRUSHED S/STEEL Inox satinato	POLISHED S/STEEL Inox lucido
4411/KR	Mod. 4018	1001 	€ 333,00 Gold column only Solo colonna oro	€ 277,00	€ 310,00
4411/KR_4000	Mod. 4000*				
4411/KR REG	Mod. 4018	1003 		€ 285,00	€ 318,00
4411/KR REG_4000	Mod. 4000*				

METHACRYLATE FINISHES / Finiture metacrilato



PACKING / Imballo



TECHNICAL DETAILS / Dettagli tecnici

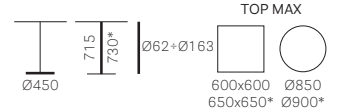

Krystal



CODE Codice	CROSS Crociera	FEET Piedino	BLACK POWDER COATED Verniciato nero	BRUSHED S/STEEL Inox satinato	POLISHED S/STEEL Inox lucido
4421/KR	Mod. 4018	1001 	€ 349,00 Gold column only Solo colonna oro	€ 318,00	€ 341,00
4421/KR_4000	Mod. 4000*				
4421/KR REG	Mod. 4018	1003 		€ 325,00	€ 349,00
4421/KR REG_4000	Mod. 4000*				

METHACRYLATE FINISHES / Finiture metacrilato

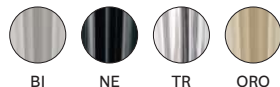

PACKING / Imballo



TECHNICAL DETAILS / Dettagli tecnici

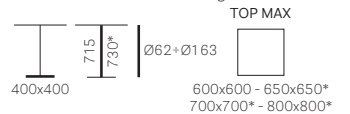

For colours and finishes see at page 280
Per colori e finiture vedere da pagina 280

Krystal



CODE Codice	CROSS Crociera	FEET Piedino	BLACK POWDER COATED Verniciato nero	BRUSHED S/STEEL Inox satinato	POLISHED S/STEEL Inox lucido
4431/KR	Mod. 4008Y	1001 	€ 415,00 Gold column only Solo colonna oro	€ 380,00	€ 394,00
4431/KR REG		1003 		€ 392,00	€ 405,00

METHACRYLATE FINISHES / Finiture metacrilato

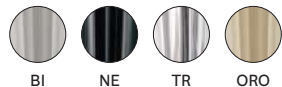

PACKING / Imballo

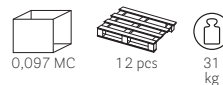

TECHNICAL DETAILS / Dettagli tecnici

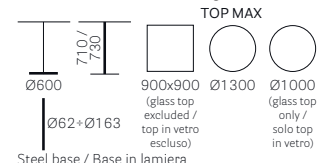

Laja



CODE Codice	CROSS Crociera	FEET Piedino	POWDER COATED Verniciato	POWDER COATED FOR OUTDOOR Verniciato per esterno	POLISHED ALUMINIUM Alluminio lucidato	ANTIQU BRASS Ottone anticato	TITANIUM Titanio
5420	Mod. 4008Y	1009 	€ 156,00	€ 182,00	€ 182,00	€ 306,00	€ 306,00
5420/LU	Mod. 4000NY						
5420/OA	Mod. 4008Y						
5420/TN	Mod. 4008Y						

PACKING / Imballo

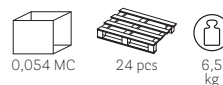

TECHNICAL DETAILS / Dettagli tecnici

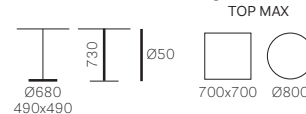

Laja



CODE Codice	CROSS Crociera	FEET Piedino	POWDER COATED Verniciato	POWDER COATED FOR OUTDOOR Verniciato per esterno	POLISHED ALUMINIUM Alluminio lucidato	ANTIQU BRASS Ottone anticato	TITANIUM Titanio
5420 H400	Mod. 4008Y	1009 	€ 164,00	€ 190,00	€ 190,00	€ 314,00	€ 314,00
5420/LU H400	Mod. 4000NY						
5420/OA H400	Mod. 4008Y						
5420/TN H400	Mod. 4008Y						

PACKING / Imballo

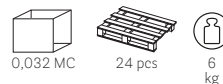

TECHNICAL DETAILS / Dettagli tecnici

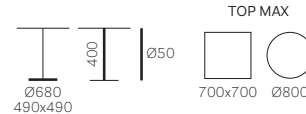

Laja



CODE Codice	CROSS Crociera	FEET Piedino	POWDER COATED Verniciato	POWDER COATED FOR OUTDOOR Verniciato per esterno	POLISHED ALUMINIUM Alluminio lucidato	ANTIQUÉ BRASS Ottone anticato	TITANIUM Titanio
5424	Mod. 4008Y	1009 	€ 169,00	€ 195,00 	€ 195,00	€ 319,00	€ 319,00
5424/LU	Mod. 4000NY						
5424/OA	Mod. 4008Y						
5424/TN	Mod. 4008Y						

PACKING / Imballo

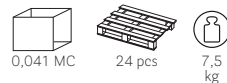

TECHNICAL DETAILS / Dettagli tecnici
TOP MAX



Laja



CODE Codice	CROSS Crociera	FEET Piedino	POWDER COATED Verniciato	POWDER COATED FOR OUTDOOR Verniciato per esterno	POLISHED ALUMINIUM Alluminio lucidato	ANTIQUÉ BRASS Ottone anticato	TITANIUM Titanio
5430	Mod. 4008Y	1009 	€ 182,00	€ 208,00 	€ 208,00	€ 338,00	€ 338,00
5430/LU							
5430/OA							
5430/TN							

PACKING / Imballo

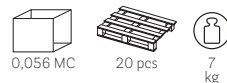

TECHNICAL DETAILS / Dettagli tecnici
TOP MAX



Laja



CODE Codice	CROSS Crociera	FEET Piedino	POWDER COATED Verniciato	POWDER COATED FOR OUTDOOR Verniciato per esterno	POLISHED ALUMINIUM Alluminio lucidato	ANTIQUÉ BRASS Ottone anticato	TITANIUM Titanio
5430 H400	Mod. 4008Y	1009 	€ 190,00	€ 216,00 	€ 216,00	€ 346,00	€ 346,00
5430/LU H400							
5430/OA H400							
5430/TN H400							

PACKING / Imballo

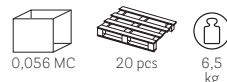

TECHNICAL DETAILS / Dettagli tecnici
TOP MAX



Laja



CODE Codice	CROSS Crociera	FEET Piedino	POWDER COATED Verniciato	POWDER COATED FOR OUTDOOR Verniciato per esterno	POLISHED ALUMINIUM Alluminio lucidato	ANTIQUE BRASS Ottone anticato	TITANIUM Titanio
5434			€ 208,00	€ 234,00			
5434/LU	Mod. 4008Y	1009			€ 234,00		
5434/OA						€ 364,00	
5434/TN							€ 364,00

PACKING / Imballo

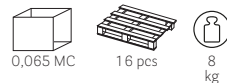

TECHNICAL DETAILS / Dettagli tecnici
TOP MAX



Liberty



CODE Codice	CROSS Crociera	FEET Piedino	BLACK POWDER COATED Verniciato nero	POWDER COATED Verniciato	OUTDOOR FINISHES Finiture per esterno
4200	Mod. 4008Y	1001	€ 260,00	€ 270,00	€ 296,00
4200 REG		1003	€ 271,00	€ 280,00	€ 306,00

PACKING / Imballo

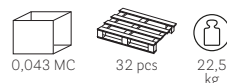

TECHNICAL DETAILS / Dettagli tecnici
TOP MAX



Liberty



CODE Codice	CROSS Crociera	FEET Piedino	BLACK POWDER COATED Verniciato nero	POWDER COATED Verniciato	OUTDOOR FINISHES Finiture per esterno
4210	Mod. 4008Y	1001	€ 355,00	€ 364,00	€ 390,00
4210 REG		1003	€ 366,00	€ 375,00	€ 401,00

PACKING / Imballo

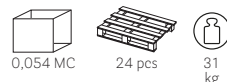

TECHNICAL DETAILS / Dettagli tecnici
TOP MAX



For colours and finishes see at page 280
Per colori e finiture vedere da pagina 280

Liberty



CODE Codice	CROSS Crociera	FEET Piedino	BLACK POWDER COATED Verniciato nero	POWDER COATED Verniciato	OUTDOOR FINISHES Finiture per esterno
4230	Mod. 4008Y	1001 	€ 379,00	€ 388,00	€ 414,00
4230 REG		1003 	€ 389,00	€ 398,00	€ 424,00

PACKING / Imballo



TECHNICAL DETAILS / Dettagli tecnici
TOP MAX



Liberty



CODE Codice	CROSS Crociera	FEET Piedino	BLACK POWDER COATED Verniciato nero	POWDER COATED Verniciato	OUTDOOR FINISHES Finiture per esterno
4220	2xMod. 4008Y	1001 	€ 517,00	€ 526,00	€ 552,00
4220 REG		1003 	€ 527,00	€ 536,00	€ 562,00

PACKING / Imballo



TECHNICAL DETAILS / Dettagli tecnici
TOP MAX



Lunar



CODE Codice	CROSS Crociera	FEET Piedino	POWDER COATED Verniciato	GOLD LACQUERED Laccato oro
5440	SPEC	PD00009 PD00010 PD00011	€ 190,00	€ 284,00
			PACKING / Imballo 0,154 MC 12 pcs 8,4 kg	TECHNICAL DETAILS / Dettagli tecnici TOP MAX 420x420 730 800x800 Ø800

Lunar



CODE Codice	CROSS Crociera	FEET Piedino	POWDER COATED Verniciato	GOLD LACQUERED Laccato oro
5443	SPEC	PD00009 PD00010 PD00011	€ 182,00	€ 276,00
			PACKING / Imballo 0,117 MC 18 pcs 7 kg	TECHNICAL DETAILS / Dettagli tecnici TOP MAX 420x420 500 800x800 Ø800

Lunar



CODE Codice	CROSS Crociera	FEET Piedino	POWDER COATED Verniciato	GOLD LACQUERED Laccato oro
5444	SPEC	PD00009 PD00010 PD00011	€ 206,00	€ 299,00
			PACKING / Imballo 0,235 MC 8 pcs 10,8 kg	TECHNICAL DETAILS / Dettagli tecnici TOP MAX 420x420 1050 700x700 Ø700

Nolita



CODE Codice	CROSS Crociera	FEET Piedino	OUTDOOR FINISHES Finiture per esterno
5453		TP0007	€ 116,00

PACKING / Imballo	TECHNICAL DETAILS / Dettagli tecnici
	TOP MAX

Nolita



CODE Codice	CROSS Crociera	FEET Piedino	OUTDOOR FINISHES Finiture per esterno
5453 H480		TP0007	€ 101,00

PACKING / Imballo	TECHNICAL DETAILS / Dettagli tecnici
	TOP MAX

Nolita

Folding
Reclinabile



CODE Codice	CROSS Crociera	FEET Piedino	OUTDOOR FINISHES Finiture per esterno
5453T	Mod. 4040.10	TP0007	€ 150,00

PACKING / Imballo	TECHNICAL DETAILS / Dettagli tecnici
	TOP MAX

Nolita

CODE Codice	CROSS Crociera	FEET Piedino	OUTDOOR FINISHES Finiture per esterno
5454		TP0007	€ 120,00 



PACKING / Imballo



TECHNICAL DETAILS / Dettagli tecnici
TOP MAX

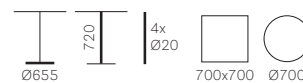

Oliva

CODE Codice	CROSS Crociera	FEET Piedino	BLACK POWDER COATED Verniciato nero	POWDER COATED Verniciato	BRUSHED S/STEEL Inox satinato	POLISHED S/STEEL Inox lucido
4150/OL	Mod. 4008	1001 	€ 305,00	€ 314,00		
4151/OL				€ 355,00	€ 355,00	
4150/OL REG		1003 	€ 312,00	€ 322,00		
4151/OL REG					€ 363,00	€ 363,00



PACKING / Imballo



TECHNICAL DETAILS / Dettagli tecnici
TOP MAX



Oliva

CODE Codice	CROSS Crociera	FEET Piedino	BLACK POWDER COATED Verniciato nero	POWDER COATED Verniciato	BRUSHED S/STEEL Inox satinato	POLISHED S/STEEL Inox lucido
4550/OL	Mod. 4008	1001 	€ 390,00	€ 400,00		
4551/OL				€ 463,00	€ 463,00	
4550/OL REG		1003 	€ 398,00	€ 407,00		
4551/OL REG					€ 471,00	€ 471,00



PACKING / Imballo



TECHNICAL DETAILS / Dettagli tecnici
TOP MAX



Quadra



CODE Codice	CROSS Crociera	FEET Piedino	BLACK POWDER COATED Verniciato nero	POWDER COATED Verniciato	OUTDOOR FINISHES Finiture per esterno
4160*	Mod. 4000NY*	1001 	€ 176,00	€ 185,00	€ 211,00
4160	Mod. 4000				
4160/LU	Mod. 4000				
4160/AC	Mod. 4000		€ 224,00	€ 233,00	
4160 REG*	Mod. 4000NY*	1003 	€ 184,00	€ 193,00	€ 219,00
4160 REG	Mod. 4000				
4160/LU REG	Mod. 4000				
4160/AC REG	Mod. 4000				

PACKING / Imballo

TECHNICAL DETAILS / Dettagli tecnici
TOP MAX

Quadra



CODE Codice	CROSS Crociera	FEET Piedino	BLACK POWDER COATED Verniciato nero	POWDER COATED Verniciato	OUTDOOR FINISHES Finiture per esterno
4163*	Mod. 4000NY*	1001 	€ 184,00	€ 193,00	€ 219,00
4163	Mod. 4000				
4163/LU	Mod. 4000				
4163/AC	Mod. 4000		€ 232,00	€ 241,00	
4163 REG*	Mod. 4000NY*	1003 	€ 192,00	€ 201,00	€ 227,00
4163 REG	Mod. 4000				
4163/LU REG	Mod. 4000				
4163/AC REG	Mod. 4000				

PACKING / Imballo

TECHNICAL DETAILS / Dettagli tecnici
TOP MAX

Quadra

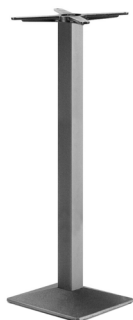

CODE Codice	CROSS Crociera	FEET Piedino	BLACK POWDER COATED Verniciato nero	POWDER COATED Verniciato	OUTDOOR FINISHES Finiture per esterno
4164*	Mod. 4000NY*	1001 	€ 202,00	€ 211,00	€ 237,00
4164	Mod. 4000				
4164/LU	Mod. 4000				
4164/AC	Mod. 4000		€ 250,00	€ 259,00	
4164 REG*	Mod. 4000NY*	1003 	€ 210,00	€ 219,00	€ 245,00
4164 REG	Mod. 4000				
4164/LU REG	Mod. 4000				
4164/AC REG	Mod. 4000				

PACKING / Imballo

TECHNICAL DETAILS / Dettagli tecnici
TOP MAX

Quadra



CODE Codice	CROSS Crociera	FEET Piedino	BLACK POWDER COATED Verniciato nero	POWDER COATED Verniciato	OUTDOOR FINISHES Finiture per esterno
4560	2xMod. 4002	1001	€ 346,00	€ 355,00	€ 381,00
4560/LU			€ 457,00	€ 466,00	
4560/AC			€ 442,00	€ 452,00	
4560 REG	2xMod. 4002	1003	€ 354,00	€ 363,00	€ 389,00
4560/LU REG			€ 465,00	€ 474,00	
4560/AC REG			€ 450,00	€ 459,00	

PACKING / Imballo

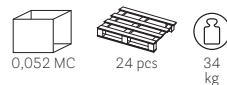
TECHNICAL DETAILS / Dettagli tecnici
TOP MAX

Quadra



CODE Codice	CROSS Crociera	FEET Piedino	BLACK POWDER COATED Verniciato nero	POWDER COATED Verniciato	OUTDOOR FINISHES Finiture per esterno
4563	2xMod. 4002	1001	€ 354,00	€ 363,00	€ 389,00
4563/LU			€ 465,00	€ 474,00	
4563/AC			€ 450,00	€ 459,00	
4563 REG	2xMod. 4002	1003	€ 362,00	€ 371,00	€ 397,00
4563/LU REG			€ 472,00	€ 481,00	
4563/AC REG			€ 458,00	€ 467,00	

PACKING / Imballo

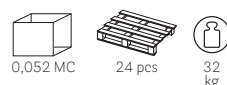
TECHNICAL DETAILS / Dettagli tecnici
TOP MAX

Quadra





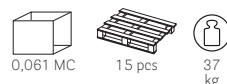
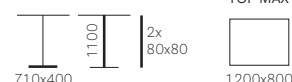

CODE Codice	CROSS Crociera	FEET Piedino	BLACK POWDER COATED Verniciato nero	POWDER COATED Verniciato	OUTDOOR FINISHES Finiture per esterno
4564	2xMod. 4002	1001	€ 372,00	€ 381,00	€ 407,00
4564/LU			€ 483,00	€ 492,00	
4564/AC			€ 468,00	€ 478,00	
4564 REG	2xMod. 4002	1003	€ 380,00	€ 389,00	€ 415,00
4564/LU REG			€ 491,00	€ 500,00	
4564/AC REG			€ 476,00	€ 485,00	

PACKING / Imballo

TECHNICAL DETAILS / Dettagli tecnici
TOP MAX

Quadra



CODE Codice	CROSS Crociera	FEET Piedino	BLACK POWDER COATED Verniciato nero	POWDER COATED Verniciato	OUTDOOR FINISHES Finiture per esterno
4570	Mod. 4008	1001 	€ 249,00	€ 258,00	€ 284,00 
4570/LU			€ 297,00	€ 306,00	
4570/AC			€ 290,00	€ 299,00	
4570 REG		1003 	€ 257,00	€ 266,00	€ 292,00 
4570/LU REG			€ 305,00	€ 314,00	
4570/AC REG			€ 298,00	€ 307,00	

PACKING / Imballo

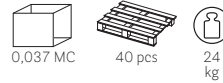





TECHNICAL DETAILS / Dettagli tecnici



HPL = Solid laminate tops / Ripiani in stratificato

Quadra



CODE Codice	CROSS Crociera	FEET Piedino	BLACK POWDER COATED Verniciato nero	POWDER COATED Verniciato	OUTDOOR FINISHES Finiture per esterno
4573	Mod. 4008	1001 	€ 257,00	€ 266,00	€ 292,00 
4573/LU			€ 305,00	€ 314,00	
4573/AC			€ 298,00	€ 307,00	
4573 REG		1003 	€ 264,00	€ 273,00	€ 299,00 
4573/LU REG			€ 312,00	€ 322,00	
4573/AC REG			€ 306,00	€ 315,00	

PACKING / Imballo

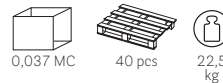





TECHNICAL DETAILS / Dettagli tecnici

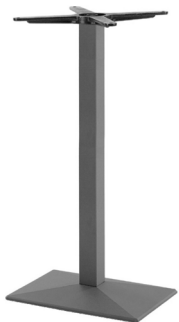

HPL = Solid laminate tops / Ripiani in stratificato

Quadra



CODE Codice	CROSS Crociera	FEET Piedino	BLACK POWDER COATED Verniciato nero	POWDER COATED Verniciato	OUTDOOR FINISHES Finiture per esterno
4574	Mod. 4008	1001 	€ 275,00	€ 284,00	€ 310,00 
4574/LU			€ 323,00	€ 332,00	
4574/AC			€ 316,00	€ 325,00	
4574 REG		1003 	€ 283,00	€ 292,00	€ 318,00 
4574/LU REG			€ 331,00	€ 340,00	
4574/AC REG			€ 324,00	€ 333,00	

PACKING / Imballo

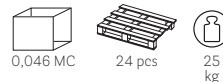





TECHNICAL DETAILS / Dettagli tecnici



For colours and finishes see at page 280
Per colori e finiture vedere da pagina 280



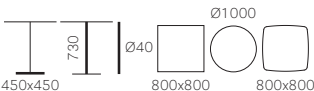

Stylus



CODE Codice	CROSS Crociera	FEET Piedino	BLACK POWDER COATED Verniciato nero	POWDER COATED Verniciato
5400	Mod. 5400.3	1006 	€ 189,00	€ 198,00
			PACKING / Imballo  0,043 MC  32 pcs  18 kg	TECHNICAL DETAILS / Dettagli tecnici TOP MAX 



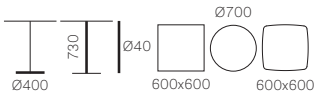

Stylus



CODE Codice	CROSS Crociera	FEET Piedino	BLACK POWDER COATED Verniciato nero	POWDER COATED Verniciato
5402	Mod. 5400.3	1006 	€ 168,00	€ 177,00
			PACKING / Imballo  0,037 MC  40 pcs  14,5 kg	TECHNICAL DETAILS / Dettagli tecnici TOP MAX 



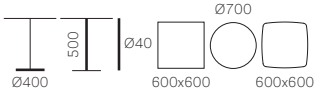

Stylus



CODE Codice	CROSS Crociera	FEET Piedino	BLACK POWDER COATED Verniciato nero	POWDER COATED Verniciato
5402 H500	Mod. 5400.3	1006 	€ 176,00	€ 185,00
			PACKING / Imballo  0,022 MC  40 pcs  13,5 kg	TECHNICAL DETAILS / Dettagli tecnici TOP MAX 



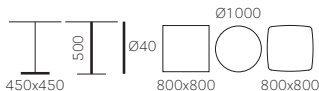

Stylus



CODE Codice	CROSS Crociera	FEET Piedino	BLACK POWDER COATED Verniciato nero	POWDER COATED Verniciato
5403	Mod. 5400,3	1006 	€ 189,00	€ 198,00
			PACKING / Imballo  0,043 MC  32 pcs  17,5 kg	TECHNICAL DETAILS / Dettagli tecnici TOP MAX 





Stylus



CODE Codice	CROSS Crociera	FEET Piedino	BLACK POWDER COATED Verniciato nero	POWDER COATED Verniciato
5404	Mod. 5400,3	1006 	€ 215,00	€ 224,00
			PACKING / Imballo  0,036 MC  32 pcs  19 kg	TECHNICAL DETAILS / Dettagli tecnici TOP MAX 

Stylus

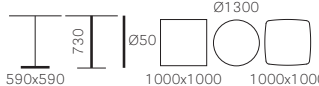

CODE Codice	CROSS Crociera	FEET Piedino	BLACK POWDER COATED Verniciato nero	POWDER COATED Verniciato
5410	Mod. 4008Y	1006 	€ 263,00	€ 272,00
			PACKING / Imballo  0,056 MC  16 pcs  28,5 kg	TECHNICAL DETAILS / Dettagli tecnici TOP MAX 

Stylus

VAT NOT INCLUDED / Iva esclusa

Table bases / Basamenti



CODE Codice	CROSS Crociera	FEET Piedino	BLACK POWDER COATED Verniciato nero	POWDER COATED Verniciato
5413	Mod. 4008Y	1006 	€ 263,00	€ 272,00

PACKING / Imballo

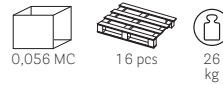

TECHNICAL DETAILS / Dettagli tecnici

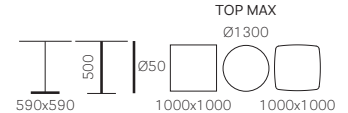

Tonda



CODE Codice	CROSS Crociera	FEET Piedino	BLACK POWDER COATED Verniciato nero	POWDER COATED Verniciato	OUTDOOR FINISHES Finiture per esterno
4150*	Mod. 4000NY*	1001 	€ 150,00	€ 159,00	€ 185,00
4150	Mod. 4000				
4150/CR					
4150/AC					
4150 REG*	Mod. 4000NY*	1003 	€ 160,00	€ 169,00	€ 195,00
4150 REG	Mod. 4000				
4150/CR REG					
4150/AC REG					

PACKING / Imballo



TECHNICAL DETAILS / Dettagli tecnici



Tonda



CODE Codice	CROSS Crociera	FEET Piedino	CHROMED Cromato	BRUSHED S/STEEL Inox satinato
4151/CR	Mod. 4000	1001 	€ 190,00	€ 206,00
4151/AC				
4151/AC 316*				
4151/CR REG	Mod. 4000	1003 	€ 201,00	€ 216,00
4151/AC REG				
4151/AC 316 REG*				

PACKING / Imballo



TECHNICAL DETAILS / Dettagli tecnici

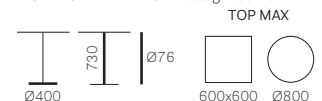

For colours and finishes see at page 280
Per colori e finiture vedere da pagina 280

Tonda



CODE Codice	CROSS Crociera	FEET Piedino	BLACK POWDER COATED Verniciato nero	POWDER COATED Verniciato	BRUSHED S/STEEL Inox satinato	POLISHED S/STEEL Inox lucido
4150/RV	Mod. 4000	1001 	€ 272,00	€ 281,00		
4151/RV					€ 301,00	€ 307,00
4150/RV REG	Mod. 4000	1003 	€ 283,00	€ 292,00		
4151/RV REG					€ 311,00	€ 318,00

PACKING / Imballo

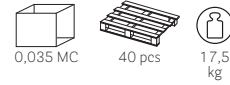



TECHNICAL DETAILS / Dettagli tecnici
TOP MAX



Tonda



CODE Codice	CROSS Crociera	FEET Piedino	CHROMED Cromato	BRUSHED S/STEEL Inox satinato
4153/CR	Mod. 4001	1001 	€ 177,00	
4153/AC				€ 214,00
4153/CR REG	Mod. 4001	1003 	€ 188,00	
4153/AC REG				€ 224,00

PACKING / Imballo

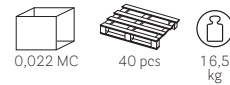



TECHNICAL DETAILS / Dettagli tecnici
TOP MAX



Tonda



CODE Codice	CROSS Crociera	FEET Piedino	BLACK POWDER COATED Verniciato nero	POWDER COATED Verniciato	OUTDOOR FINISHES Finiture per esterno	CHROMED Cromato	BRUSHED S/STEEL Inox satinato
4154*	Mod. 4000NY*	1001 			€ 218,00 		
4154				€ 182,00	€ 192,00		
4154/CR	Mod. 4000		€ 211,00	€ 220,00		€ 253,00	
4154/AC			€ 223,00	€ 232,00			€ 258,00
4154 REG*	Mod. 4000NY*	1003 			€ 228,00 		
4154 REG				€ 193,00	€ 202,00		
4154/CR REG	Mod. 4000		€ 231,00	€ 240,00		€ 263,00	
4154/AC REG			€ 231,00	€ 240,00			€ 268,00

PACKING / Imballo



TECHNICAL DETAILS / Dettagli tecnici
TOP MAX



Tonda



CODE Codice	CROSS Crociera	FEET Piedino	BLACK POWDER COATED Verniciato nero	POWDER COATED Verniciato	CHROMED Cromato	BRUSHED S/STEEL Inox satinato
4154R	Mod. 4000	1001	€ 276,00	€ 285,00		
4154R/CR			€ 305,00	€ 314,00	€ 348,00	
4154R/AC			€ 371,00	€ 380,00		€ 410,00
4154R REG		1003	€ 286,00	€ 296,00		
4154R/CR REG			€ 315,00	€ 324,00	€ 358,00	
4154R/AC REG			€ 381,00	€ 390,00		€ 420,00

PACKING / Imballo

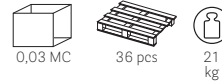

TECHNICAL DETAILS / Dettagli tecnici



Tonda



CODE Codice	CROSS Crociera	FEET Piedino	BLACK POWDER COATED Verniciato nero	POWDER COATED Verniciato	OUTDOOR FINISHES Finiture per esterno
4530	Mod. 4008	1001	€ 280,00	€ 289,00	€ 315,00
4530/CR			€ 332,00	€ 341,00	
4530/AC			€ 355,00	€ 364,00	
4530 REG		1003	€ 290,00	€ 299,00	€ 325,00
4530/CR REG			€ 342,00	€ 351,00	
4530/AC REG			€ 366,00	€ 375,00	

PACKING / Imballo

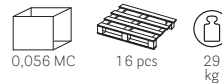

TECHNICAL DETAILS / Dettagli tecnici



Tonda



CODE Codice	CROSS Crociera	FEET Piedino	BLACK POWDER COATED Verniciato nero	POWDER COATED Verniciato
4530/RV	Mod. 4008	1001	€ 429,00	€ 439,00
4530/RV REG		1003	€ 440,00	€ 449,00

PACKING / Imballo

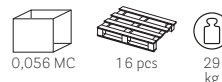

TECHNICAL DETAILS / Dettagli tecnici

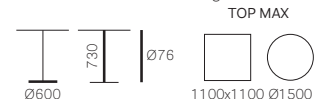

Tonda



CODE Codice	CROSS Crociera	FEET Piedino	BLACK POWDER COATED Verniciato nero	POWDER COATED Verniciato	OUTDOOR FINISHES Finiture per esterno
4533	Mod. 4008	1001	€ 288,00	€ 297,00	€ 323,00
4533/CR			€ 340,00	€ 349,00	
4533/AC			€ 363,00	€ 372,00	
4533 REG		1003	€ 298,00	€ 307,00	€ 333,00
4533/CR REG			€ 350,00	€ 359,00	
4533/AC REG			€ 374,00	€ 383,00	

PACKING / Imballo

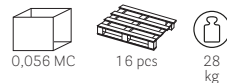
TECHNICAL DETAILS / Dettagli tecnici
TOP MAX

Tonda



CODE Codice	CROSS Crociera	FEET Piedino	BLACK POWDER COATED Verniciato nero	POWDER COATED Verniciato	OUTDOOR FINISHES Finiture per esterno
4534	Mod. 4008	1001	€ 306,00	€ 315,00	€ 341,00
4534/CR			€ 358,00	€ 367,00	
4534/AC			€ 381,00	€ 390,00	
4534 REG		1003	€ 316,00	€ 325,00	€ 351,00
4534/CR REG			€ 368,00	€ 377,00	
4534/AC REG			€ 392,00	€ 401,00	

PACKING / Imballo

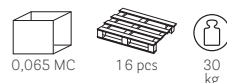
TECHNICAL DETAILS / Dettagli tecnici
TOP MAX

Tonda





CODE Codice	CROSS Crociera	FEET Piedino	BLACK POWDER COATED Verniciato nero	POWDER COATED Verniciato	OUTDOOR FINISHES Finiture per esterno
4550	Mod. 4008	1001	€ 251,00	€ 260,00	€ 286,00
4550/CR			€ 272,00	€ 281,00	
4550/AC			€ 297,00	€ 306,00	
4550 REG		1003	€ 262,00	€ 271,00	€ 297,00
4550/CR REG			€ 283,00	€ 292,00	
4550/AC REG			€ 307,00	€ 316,00	

PACKING / Imballo

TECHNICAL DETAILS / Dettagli tecnici
TOP MAX

Tonda



CODE Codice	CROSS Crociera	FEET Piedino	CHROMED Cromato	BRUSHED S/STEEL Inox satinato
4551/CR	Mod. 4008	1001 	€ 331,00	€ 351,00
4551/AC				
4551/CR REG		1003 	€ 341,00	€ 362,00
4551/AC REG				

PACKING / Imballo

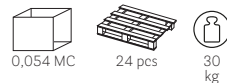
TECHNICAL DETAILS / Dettagli tecnici
TOP MAX

Tonda





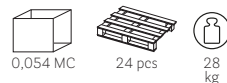

CODE Codice	CROSS Crociera	FEET Piedino	BLACK POWDER COATED Verniciato nero	POWDER COATED Verniciato	BRUSHED S/STEEL Inox satinato	POLISHED S/STEEL Inox lucido
4550/RV	Mod. 4008	1001 	€ 370,00	€ 379,00	€ 446,00	€ 449,00
4551/RV						
4550/RV REG		1003 	€ 380,00	€ 389,00	€ 457,00	€ 459,00
4551/RV REG						

PACKING / Imballo

TECHNICAL DETAILS / Dettagli tecnici
TOP MAX

Tonda



CODE Codice	CROSS Crociera	FEET Piedino	BLACK POWDER COATED Verniciato nero	POWDER COATED Verniciato	OUTDOOR FINISHES Finiture per esterno	CHROMED Cromato	BRUSHED S/STEEL Inox satinato
4553	Mod. 4008	1001 	€ 259,00	€ 268,00	€ 294,00 	€ 331,00	€ 351,00
4553/CR							
4553/AC		1003 	€ 297,00	€ 306,00	€ 305,00 	€ 341,00	€ 362,00
4553 REG							
4553/CR REG							
4553/AC REG							

PACKING / Imballo

TECHNICAL DETAILS / Dettagli tecnici
TOP MAX

Tonda



CODE Codice	CROSS Crociera	FEET Piedino	BLACK POWDER COATED Verniciato nero	POWDER COATED Verniciato	OUTDOOR FINISHES Finiture per esterno	CHROMED Cromato	BRUSHED S/STEEL Inox satinato
4554	Mod. 4008	1001	€ 277,00	€ 286,00	€ 312,00	€ 385,00	€ 429,00
4554/CR			€ 305,00	€ 314,00			
4554/AC			€ 351,00	€ 361,00			
4554 REG		1003	€ 288,00	€ 297,00	€ 323,00	€ 396,00	€ 440,00
4554/CR REG			€ 315,00	€ 324,00			
4554/AC REG			€ 362,00	€ 371,00			

PACKING / Imballo

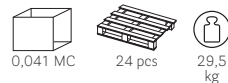

TECHNICAL DETAILS / Dettagli tecnici
TOP MAX



Venice



CODE Codice	CROSS Crociera	FEET Piedino	BLACK POWDER COATED Verniciato nero	POWDER COATED Verniciato	OUTDOOR FINISHES Finiture per esterno
4950		1000	€ 207,00	€ 216,00	€ 236,00

PACKING / Imballo



TECHNICAL DETAILS / Dettagli tecnici
TOP MAX



Florence



CODE Codice	CROSS Crociera	FEET Piedino	BLACK POWDER COATED Verniciato nero	POWDER COATED Verniciato	OUTDOOR FINISHES Finiture per esterno
4960		1000	€ 262,00	€ 271,00	€ 289,00

PACKING / Imballo





TECHNICAL DETAILS / Dettagli tecnici
TOP MAX



Verona



CODE Codice	CROSS Crociera	FEET Piedino	BLACK POWDER COATED Verniciato nero	POWDER COATED Verniciato	OUTDOOR FINISHES Finiture per esterno
4990		1000 	€ 387,00	€ 396,00	€ 414,00 

PACKING / Imballo

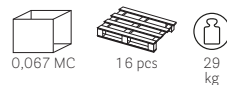

TECHNICAL DETAILS / Dettagli tecnici
TOP MAX

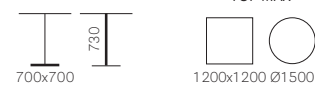

Ypsilon



CODE Codice	CROSS Crociera	FEET Piedino	POWDER COATED Verniciato	POLISHED ALUMINIUM Alluminio lucidato	ANODIZED ALUMINIUM Alluminio anodizzato	POWDER COATED FOR OUTDOOR Verniciato per esterno
4790			€ 175,00			€ 199,00 
4790/LU	Mod. 4790,3	SPEC		€ 233,00		
4790/AA					€ 266,00 	

PACKING / Imballo

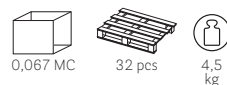

TECHNICAL DETAILS / Dettagli tecnici
TOP MAX



Ypsilon



CODE Codice	CROSS Crociera	FEET Piedino	POWDER COATED Verniciato	POLISHED ALUMINIUM Alluminio lucidato	ANODIZED ALUMINIUM Alluminio anodizzato	POWDER COATED FOR OUTDOOR Verniciato per esterno
4793			€ 184,00			€ 207,00 
4793/LU	Mod. 4790,3	SPEC		€ 241,00		
4793/AA					€ 275,00 	

PACKING / Imballo

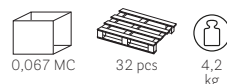

TECHNICAL DETAILS / Dettagli tecnici
TOP MAX



Ypsilon



CODE Codice	CROSS Crociera	FEET Piedino	POWDER COATED Verniciato	POLISHED ALUMINIUM Alluminio lucidato	ANODIZED ALUMINIUM Alluminio anodizzato	POWDER COATED FOR OUTDOOR Verniciato per esterno
4794			€ 207,00			€ 233,00 ☀️
4794/LU	Mod. 4790.3	SPEC		€ 266,00		
4794/AA					€ 298,00 ☀️	

PACKING / Imballo

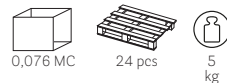

TECHNICAL DETAILS / Dettagli tecnici
TOP MAX



Ypsilon

Stackable
Accatastabile



CODE Codice	CROSS Crociera	FEET Piedino	POWDER COATED Verniciato	POLISHED ALUMINIUM Alluminio lucidato	ANODIZED ALUMINIUM Alluminio anodizzato	POWDER COATED FOR OUTDOOR Verniciato per esterno
4790T			€ 199,00			€ 224,00 ☀️
4790T/LU	Mod. 4040.10	SPEC		€ 257,00		
4790T/AA					€ 290,00 ☀️	

PACKING / Imballo

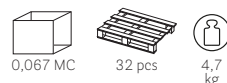

TECHNICAL DETAILS / Dettagli tecnici
TOP MAX



Ypsilon

Stackable
Accatastabile



CODE Codice	CROSS Crociera	FEET Piedino	POWDER COATED Verniciato	POLISHED ALUMINIUM Alluminio lucidato	ANODIZED ALUMINIUM Alluminio anodizzato	POWDER COATED FOR OUTDOOR Verniciato per esterno
4794T			€ 233,00			€ 257,00 ☀️
4794T/LU	Mod. 4040.10	SPEC		€ 290,00		
4794T/AA					€ 324,00 ☀️	

PACKING / Imballo



TECHNICAL DETAILS / Dettagli tecnici
TOP MAX



For colours and finishes see at page 280
Per colori e finiture vedere da pagina 280

Ypsilon

For glass tops
Per ripiani in vetro



CODE Codice	CROSS Crociera	FEET Piedino	POWDER COATED Verniciato	POLISHED ALUMINIUM Alluminio lucidato	ANODIZED ALUMINIUM Alluminio anodizzato
4790V			€ 158,00		
4790V/LU		SPEC		€ 216,00	
4790V/AA					€ 249,00

PACKING / Imballo

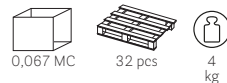

TECHNICAL DETAILS / Dettagli tecnici
TOP MAX



Ypsilon

For glass tops
Per ripiani in vetro



CODE Codice	CROSS Crociera	FEET Piedino	POWDER COATED Verniciato	POLISHED ALUMINIUM Alluminio lucidato	ANODIZED ALUMINIUM Alluminio anodizzato
4793V			€ 167,00		
4793V/LU		SPEC		€ 224,00	
4793V/AA					€ 257,00

PACKING / Imballo

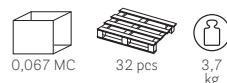

TECHNICAL DETAILS / Dettagli tecnici
TOP MAX



Ypsilon 4



CODE Codice	CROSS Crociera	FEET Piedino	POWDER COATED Verniciato	POLISHED ALUMINIUM Alluminio lucidato	POWDER COATED FOR OUTDOOR Verniciato per esterno
4795		1005	€ 216,00		€ 255,00
4795/LU	Mod. 4008Y			€ 238,00	

PACKING / Imballo



TECHNICAL DETAILS / Dettagli tecnici
TOP MAX



For colours and finishes see at page 280
Per colori e finiture vedere da pagina 280

Ypsilon 4



CODE Codice	CROSS Crociera	FEET Piedino	POWDER COATED Verniciato	POLISHED ALUMINIUM Alluminio lucidato	POWDER COATED FOR OUTDOOR Verniciato per esterno
4795 H500	Mod. 4008Y	1005 	€ 216,00		€ 255,00 
4795/LU H500				€ 238,00	

PACKING / Imballo



TECHNICAL DETAILS / Dettagli tecnici
TOP MAX



Ypsilon 4

For glass tops
Per ripiani in vetro



CODE Codice	CROSS Crociera	FEET Piedino	POWDER COATED Verniciato	POLISHED ALUMINIUM Alluminio lucidato
4795V		1005 	€ 199,00	
4795V/LU				€ 224,00

PACKING / Imballo

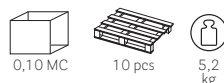

TECHNICAL DETAILS / Dettagli tecnici
TOP MAX



Ypsilon 4

For glass tops
Per ripiani in vetro



CODE Codice	CROSS Crociera	FEET Piedino	POWDER COATED Verniciato	POLISHED ALUMINIUM Alluminio lucidato
4795V H500		1005 	€ 199,00	
4795V/LU H500				€ 224,00

PACKING / Imballo



TECHNICAL DETAILS / Dettagli tecnici
TOP MAX



For colours and finishes see at page 280
Per colori e finiture vedere da pagina 280

Ypsilon 4



CODE Codice	CROSS Crociera	FEET Piedino	POWDER COATED Verniciato	POLISHED ALUMINIUM Alluminio lucidato	POWDER COATED FOR OUTDOOR Verniciato per esterno
4797	Mod. 4008Y		€ 184,00		
4797*	Mod. 4000NY*	1005 			€ 216,00 
4797/LU	Mod. 4008Y			€ 220,00	

PACKING / Imballo



TECHNICAL DETAILS / Dettagli tecnici
TOP MAX



Ypsilon 4



CODE Codice	CROSS Crociera	FEET Piedino	POWDER COATED Verniciato	POLISHED ALUMINIUM Alluminio lucidato	POWDER COATED FOR OUTDOOR Verniciato per esterno
4797 H500	Mod. 4008Y		€ 184,00		
4797 H500*	Mod. 4000NY*	1005 			€ 216,00 
4797/LU H500	Mod. 4008Y			€ 220,00	

PACKING / Imballo



TECHNICAL DETAILS / Dettagli tecnici
TOP MAX



Ypsilon 4

For glass tops
Per ripiani in vetro



CODE Codice	CROSS Crociera	FEET Piedino	POWDER COATED Verniciato	POLISHED ALUMINIUM Alluminio lucidato
4797V			€ 167,00	
4797V/LU		1005 		€ 203,00

PACKING / Imballo

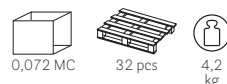

TECHNICAL DETAILS / Dettagli tecnici
TOP MAX



Ypsilon 4

For glass tops
Per ripiani in vetro



CODE Codice	CROSS Crociera	FEET Piedino	POWDER COATED Verniciato	POLISHED ALUMINIUM Alluminio lucidato
4797V H500		1005 	€ 167,00	
4797V/LU H500				€ 203,00

PACKING / Imballo

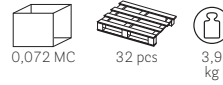

TECHNICAL DETAILS / Dettagli tecnici
TOP MAX



Ypsilon 4

Folding
Reclinabile







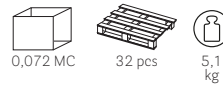







CODE Codice	CROSS Crociera	FEET Piedino	POWDER COATED Verniciato	POLISHED ALUMINIUM Alluminio lucidato	POWDER COATED FOR OUTDOOR Verniciato per esterno
4797T		1005 	€ 207,00		€ 241,00 
4797T/LU	Mod. 4040.10			€ 245,00	









PACKING / Imballo



TECHNICAL DETAILS / Dettagli tecnici
TOP MAX



	CODE Codice	SIZES Dimensioni	DESCRIPTION Descrizione	SUITABLE FOR Adatto per
ADJUSTABLE FEET Piedini regolabili 	1000	Ø30		1000: 4950, 4960, 4990
	1003	Ø30	Adjustable feet Piedino regolabile	1003: any table base with REG code (adjustable) / tutti i basamenti con codice REG (regolabile), 4750, 4753, 4752, 4752H500, 4754, 4756, 4757, 4757H500, 4758, 4758H500, 4759, 4759H500, 5475, 5475H500, 5476, 5477, 5477 H500
	1006	Ø30		1006: any table base with REG code (adjustable) / tutti i basamenti con codice REG (regolabile) 5400, 5402, 5402H500, 5403, 5404, 5410, 5413, 5465, 5465H500, 5466
	1008	Ø25		1008: 866
	1005	Ø24	Adjustable feet Piedino regolabile	1005: 4795, 4795H500, 4795V, 4795VH500, 4797, 4797H500, 4797V, 4797VH500, 4797T
	1009	Ø20		1009: 5420, 5420H400, 5424, 5430, 5430H400, 5434
	PD00009 PD00010 PD00011	Ø37	Adjustable feet Piedino regolabile	5440, 5443, 5444
PLASTIC FEET Piedini in gomma 	865.2		Plastic feet Piedino in gomma	865, 865V, 863, 863V
	TP0007	Ø20	Plastic feet Piedino in gomma	5453, 5453H480, 5453T, 5454
	1001	Ø18	Plastic feet Piedino in gomma	Suitable for any other table base Adatto per tutti gli altri basamenti
S/STEEL PLATE Piastrine in inox 	4011 4013	Ø90 Ø120	Fitting for glass top Piastra per piano in vetro	Top max Ø900 Top max Ø1300
CAST-IRON/STEEL PLATE Piastrine ghisa/acciaio 	865.3	Ø300	Cast-iron plate Piastra in ghisa	865, 866, 863
	867.3	Ø300	Steel plate Piastra in acciaio	867, 868
	869.3	325x325		869
	869.10	Ø1190	Steel cross Crociera in acciaio	869/2
	4018	Ø185	Cast-iron plate Piastra in ghisa	4401/KR, 4411/KR, 4421/KR
FOLDING MECHANISM Meccanismo reclinabile 	4040.10	Ø270	Nylon folding mechanism Meccanismo reclinabile in nylon	4790T, 4794T, 4797T, 5453T, 5470T, 5474T

	CODE Codice	SIZES Dimensioni	DESCRIPTION Descrizione	SUITABLE FOR Adatto per
<p>CROSS Crociere</p> 	4000	450x450	Cast-iron cross Crociere in ghisa	ARK4, ARK4H105, 855, 855H500, 855H1100, 4150, 4154, 4154R, 4160, 4163, 4164, 4400, 4404, 4410, 4412, 4414, 4414R, 4420, 4424, 4440, 4443, 4444, 4460, 4463, 4462, 4462H500, 4464, 4466, 4411/KR, 4421/KR, 4750, 4752, 4752H500, 4754, 4756, 4758, 4758H500, 4903, 5460, 5464, 5465, 5465H500, 5466
	4000NY	450x450	Nylon cross Crociere in nylon	4150, 4154, 4160, 4163, 4164, 4421/AC316, 4750, 4752, 4752H500, 4754, 4756, 4758, 4758H500, 4797, 4797H500, 5420, 5420H400, 5424, 5460, 5464, 5465, 5465H500, 5466
	4001	225x225	Cast-iron cross Crociere in ghisa	4153, 4401/FX H500, 4402H, 4406H, 4413, 4413/FX, 4423, 4423/FX, 4433/FX, 4463/FX
	4002	460x285	Cast-iron cross Crociere in ghisa	4560, 4563, 4564, 4759, 4759H500, 4757, 4757H500
	4006	225x225	Cast-iron cross Crociere in ghisa	4400H500, 4402H500, 4412H500, 4753, ARK3, 5463
	4008	450x450	Cast-iron cross Crociere in ghisa	4150/OL, 4401/FX, 4411/FX, 4414/FX, 4421/FX, 4424/FX, 4430, 4431/FX, 4433, 4434, 4434/FX, 4441/FX, 4443/FX, 4461/FX, 4462/FXH500, 4462/FX, 4464/FX, 4470, 4471/FX, 4473, 4472, 4472H500, 4474, 4481/FM, 4482/FM, 4490, 4493, 4492, 4492H500, 4494, 4530, 4533, 4534, 4550, 4553, 4554, 4550/OL, 4570, 4573, 4574, 4901, 4452, 4452H500, 4456
	4008Y	450x450	Cast-iron cross Crociere in ghisa	4200, 4210, 4230, 4220, 4431/KR, 4795, 4795H500, 4797, 4797H500, 5410, 5413, 5420, 5420H400, 5424, 5430, 5430H400, 5434
	4015	450x450	Cast-iron cross Crociere in ghisa	4402, 4406, 4462/RV, 4467, 4467H500, 4475, 4475H500
	4016.80	700x700	Steel cross Crociere in acciaio	4497

	CODE Codice	SIZES Dimensioni	DESCRIPTION Descrizione	SUITABLE FOR Adatto per
CROSS Crociere 	4437.10	Ø1190	Steel cross Crociere in acciaio	4437
	4499.10	Ø1190	Steel cross Crociere in acciaio	4499
	4790.3	230x230	Aluminium cross Crociere in alluminio	4790, 4793, 4794
	5400.3	270x270	Cast-iron cross Crociere in ghisa	5400, 5402, 5402H500, 5403, 5404
	5470.3	230x230	Aluminium cross Crociere in alluminio	5470, 5473, 5474
	5475.3	450x450	Cast-iron cross Crociere in ghisa	5475, 5475H500, 5476, 5477, 5477 H500

ON DEMAND / A richiesta

Suggested for wood, ceramic and marble floors / Consigliati per pavimenti in legno, marmo e ceramica



KIT/FELTRO.CURVO.6

KIT n.6 ADHESIVE FELTS FOR ROUND BASES ≤ Ø600 mm: surcharge € 4,00
 KIT n.6 FELTRINI ADESIVI PER BASI TONDE ≤ Ø600 mm: supplemento € 4,00



KIT/FELTRO.RETT.4

KIT n.4 ADHESIVE FELTS FOR SQUARE/RECTANGULAR BASES ≤ 500 mm: surcharge € 3,00
 KIT n.4 FELTRINI ADESIVI PER BASI QUADRATE/RETTANGOLARI ≤ 500 mm: supplemento € 3,00

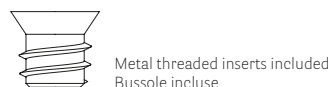

FENIX®
mm 10

FNP



Flat edge
Bordo piatto

Colours / Colori



0720

Black core
Anima nera

SIZES (mm)
Misure

Price
Prezzo

	Ø 490	€ 130,00
	Ø 590	€ 177,00
	Ø 690	€ 231,00
	Ø 790	€ 306,00
	Ø 890	€ 379,00
	Ø 990	€ 458,00
	Ø 1190	€ 706,00
R10 (standard) On request, same price / su richiesta, allo stesso prezzo: 	590x590	€ 177,00
	690x690	€ 231,00
	790x790	€ 306,00
	890x890	€ 379,00
R10 (standard) On request, same price / su richiesta, allo stesso prezzo: 	690x590	€ 210,00
	750x650	€ 236,00
	790x590	€ 241,00
	790x690	€ 272,00
	1190x790	€ 465,00 *
	1290x790	€ 498,00 *
	1590x790	€ 613,00 *
 For Laja 5420 (h500 or h400) Per Laja 5420 (h500 o h400)	700x570	€ 214,00

* Price includes reinforcing bars / Il prezzo include i tubi di rinforzo

On request, customized sizes and radius angle can be manufactured / Su richiesta si possono produrre misure speciali e angoli a raggio speciale



Metal threaded inserts included
Bussole incluse

FENIX®
Marble effect / Effetto marmo
mm 10

FNI

FNT

FNP



Chamfered edge
Bordo inclinato

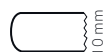

Round edge
Bordo tondo



Flat edge
Bordo piatto

Colours / Colori



3452
Black core
Anima nera

Colours / Colori



3455
White core
Anima bianca

SIZES (mm)
Misure

Price
Prezzo

	Ø 490	€ 133,00	€ 179,00
	Ø 590	€ 192,00	€ 266,00
	Ø 690	€ 258,00	€ 366,00
	Ø 790	€ 376,00	€ 535,00
	Ø 890	€ 437,00	€ 626,00
	Ø 990	€ 514,00	€ 738,00
	Ø 1190	€ 770,00	€ 1.111,00
 R10 (standard) On request, same price / su richiesta, allo stesso prezzo: 	590x590	€ 192,00	€ 266,00
	690x690	€ 258,00	€ 366,00
	790x790	€ 376,00	€ 535,00
	890x890	€ 437,00	€ 626,00
 R10 (standard) On request, same price / su richiesta, allo stesso prezzo: 	690x590	€ 224,00	€ 316,00
	750x650	€ 283,00	€ 402,00
	790x590	€ 275,00	€ 383,00
	790x690	€ 324,00	€ 457,00
	1190x790	€ 530,00 *	€ 735,00 *
	1290x790	€ 546,00 *	€ 764,00 *
	1590x790	€ 728,00 *	€ 1.026,00 *
 Stylus table bases Per basamenti Stylus	590x590	€ 211,00	€ 293,00
	690x690	€ 284,00	€ 401,00
	790x790	€ 411,00	€ 575,00
	890x890	€ 472,00	€ 666,00

* Price includes reinforcing bars / Il prezzo include i tubi di rinforzo

On request, customized sizes and radius angle can be manufactured / Su richiesta si possono produrre misure speciali e angoli a raggio speciale



FENIX®
mm 20

FMP

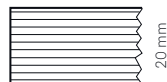

Flat edge
Bordo piatto

Colours / Colori



0720

Plywood core
Anima in multistrati

SIZES (mm) Misure		Price Prezzo
	Ø 490	€ 184,00
	Ø 590	€ 220,00
	Ø 690	€ 257,00
	Ø 790	€ 311,00
	Ø 890	€ 375,00
	Ø 990	€ 492,00
	590x590	€ 220,00
	690x690	€ 257,00
	790x790	€ 311,00
	890x890	€ 375,00
	1090x690	€ 384,00
	1190x790	€ 455,00
	1290x790	€ 492,00
	1350x790	€ 510,00
	1590x790	€ 583,00

Solid laminate / Stratificato



Metal threaded inserts included
Bussole incluse

COMPACT FULL COLOUR

mm 10

CFC



Chamfered edge
Bordo inclinato

CFP



Flat edge
Bordo piatto

Colours / Colori

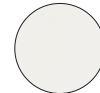

White / Bianco
White core
Anima bianca

SIZES (mm)
Misure

Price
Prezzo

	Ø 490	€ 130,00
	Ø 590	€ 177,00
	Ø 690	€ 231,00
	Ø 790	€ 306,00
	Ø 890	€ 379,00
	Ø 990	€ 458,00
	Ø 1190	€ 706,00
R10 (standard) On request, same price / su richiesta, allo stesso prezzo: <div style="display: flex; justify-content: space-around; margin-top: 5px;"> </div>	590x590	€ 177,00
	690x690	€ 231,00
	790x790	€ 306,00
	890x890	€ 379,00
R10 (standard) On request, same price / su richiesta, allo stesso prezzo: <div style="display: flex; justify-content: space-around; margin-top: 5px;"> </div>	690x590	€ 210,00
	750x650	€ 236,00
	790x590	€ 241,00
	790x690	€ 272,00
	1190x790	€ 465,00 *
	1290x790	€ 498,00 *
	1590x790	€ 613,00 *
For Stylus table bases Per basamenti Stylus	590x590	€ 195,00
	690x690	€ 254,00
	790x790	€ 337,00
	890x890	€ 418,00

* Price includes reinforcing bars / Il prezzo include i tubi di rinforzo

On request, customized sizes and radius angle can be manufactured / Su richiesta si possono produrre misure speciali e angoli a raggio speciale

Solid laminate / Stratificato



Metal threaded inserts included
Bussole incluse

COMPACT

mm 10

CFC



Chamfered edge
Bordo inclinato

CFT

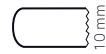

Round edge
Bordo tondo

CFP

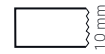

Flat edge
Bordo piatto

Colours / Colori



3445



3447

Matching core
Anima in tinta

SIZES (mm)
Misure

Price
Prezzo

	Ø 490	€ 140,00
	Ø 590	€ 195,00
	Ø 690	€ 253,00
	Ø 790	€ 306,00
	Ø 890	€ 390,00
	Ø 990	€ 455,00
	Ø 1190	€ 738,00
R10 (standard) On request, same price / su richiesta, allo stesso prezzo: R35 R60 R90	590x590	€ 195,00
	690x690	€ 253,00
	790x790	€ 306,00
	890x890	€ 390,00
R10 (standard) On request, same price / su richiesta, allo stesso prezzo: R35 R60 R90	690x590	€ 216,00
	750x650	€ 249,00
	790x590	€ 266,00
	790x690	€ 298,00
	1190x790	€ 492,00 *
	1290x790	€ 546,00 *
	1590x790	€ 674,00 *
<p>For Laja 5420 (h500 or h400) Per Laja 5420 (h500 o h400)</p>	700x570	€ 277,00

* Price includes reinforcing bars / Il prezzo include i tubi di rinforzo

On request, customized sizes and radius angle can be manufactured / Su richiesta si possono produrre misure speciali e angoli a raggio speciale

Solid laminate / Stratificato

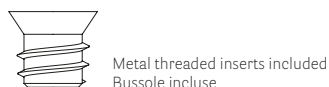

		COMPACT mm 10		
		COI	COM	COP
		Chamfered edge Bordo inclinato	Round edge Bordo tondo	Flat edge Bordo piatto
		Colours / Colori 3457 Black core Anima nera	Colours / Colori 3471 Beige core Anima beige	
			 3467 Grey core Anima grigia	
SIZES (mm) Misure		Price Prezzo		
	Ø 490	€ 117,00	€ 140,00	
	Ø 590	€ 150,00	€ 195,00	
	Ø 690	€ 199,00	€ 253,00	
	Ø 790	€ 249,00	€ 337,00	
	Ø 890	€ 315,00	€ 429,00	
	Ø 990	€ 381,00	€ 455,00	
	Ø 1190	€ 554,00	€ 738,00	
	590x590	€ 150,00	€ 195,00	
	690x690	€ 199,00	€ 253,00	
	790x790	€ 249,00	€ 306,00	
	890x890	€ 315,00	€ 390,00	
On request, same price / su richiesta, allo stesso prezzo:				
	690x590	€ 167,00	€ 216,00	
	750x650	€ 199,00	€ 249,00	
	790x590	€ 216,00	€ 266,00	
	790x690	€ 233,00	€ 298,00	
	1190x790	€ 414,00 *	€ 492,00 *	
	1290x790	€ 431,00 *	€ 546,00 *	
	1590x790	€ 530,00 *	€ 674,00 *	

* Price includes reinforcing bars / Il prezzo include i tubi di rinforzo

On request, customized sizes and radius angle can be manufactured / Su richiesta si possono produrre misure speciali e angoli a raggio speciale

Solid laminate / Stratificato



Metal threaded inserts included
Bussole incluse

COMPACT

mm 12

COI

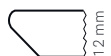

Chamfered edge
Bordo inclinato

COM



Round edge
Bordo tondo

COP



Flat edge
Bordo piatto

Colours / Colori



Black /
Nero



White /
Bianco



851

Colours / Colori



526



263

Black core
Anima nera

SIZES (mm)
Misure

Price
Prezzo

	Ø 490	€ 107,00	€ 101,00
	Ø 590	€ 127,00	€ 120,00
	Ø 690	€ 172,00	€ 158,00
	Ø 790	€ 225,00	€ 211,00
	Ø 890	€ 283,00	€ 266,00
	Ø 990	€ 335,00	€ 328,00
	Ø 1190	€ 496,00	€ 501,00
R10 (standard) On request, same price / su richiesta, allo stesso prezzo: R35 R60 R90	590x590	€ 127,00	€ 120,00
	690x690	€ 172,00	€ 158,00
	790x790	€ 225,00	€ 211,00
	890x890	€ 283,00	€ 266,00
R10 (standard) On request, same price / su richiesta, allo stesso prezzo: R35 R60 R90	690x590	€ 133,00	€ 142,00
	750x650	€ 150,00	€ 158,00
	790x590	€ 167,00	€ 175,00
	790x690	€ 184,00	€ 192,00
	1090x690	€ 292,00 *	€ 283,00 *
	1190x790	€ 346,00 *	€ 332,00 *
	1290x790	€ 401,00 *	€ 381,00 *
	1350x790	€ 420,00 *	€ 398,00 *
	1590x790	€ 439,00 *	€ 414,00 *
For Stylus table bases Per basamenti Stylus	590x590	€ 140,00	€ 132,00
	690x690	€ 189,00	€ 175,00
	790x790	€ 247,00	€ 233,00
	890x890	€ 312,00	€ 293,00

* Price includes reinforcing bars / Il prezzo include i tubi di rinforzo

On request, customized sizes and radius angle can be manufactured / Su richiesta si possono produrre misure speciali e angoli a raggio speciale

Colours are indicative. All sizes and dimensions could change within the tolerance of ±5 mm
I colori sono indicativi. Le misure indicate possono variare nella tolleranza di ±5 mm

Solid laminate / Stratificato



Metal threaded inserts included
Bussole incluse

COMPACT

mm 10

COI	COM	COP	COP
Chamfered edge Bordo inclinato	Round edge Bordo tondo	Flat edge Bordo piatto	Flat edge Bordo piatto
Colours / Colori		Colours / Colori	
247		527	
		Black core Anima nera	

SIZES (mm)
Misure

Price
Prezzo

	Ø 490	€ 85,00
	Ø 590	€ 111,00
	Ø 690	€ 137,00
	Ø 790	€ 195,00
	Ø 890	€ 234,00
	Ø 990	€ 273,00
	Ø 1190	€ 429,00
 R10 (standard) On request, same price / su richiesta, allo stesso prezzo:	590x590	€ 111,00
	690x690	€ 137,00
	790x790	€ 195,00
	890x890	€ 234,00
 R10 (standard) On request, same price / su richiesta, allo stesso prezzo:	690x590	€ 124,00
	750x650	€ 141,00
	790x590	€ 150,00
	790x690	€ 167,00
	1090x690	€ 241,00 *
	1190x790	€ 283,00 *
	1290x790	€ 298,00 *
	1350x790	€ 315,00 *
	1590x790	€ 381,00 *

* Price includes reinforcing bars / Il prezzo include i tubi di rinforzo

On request, customized sizes and radius angle can be manufactured / Su richiesta si possono produrre misure speciali e angoli a raggio speciale

Solid laminate / Stratificato



		COMPACT mm 10		
		COI	COM	COP
		Chamfered edge Bordo inclinato	Round edge Bordo tondo	Flat edge Bordo piatto
		Colours / Colori 		Colours / Colori
		4420 4384 4512 Brown core Anima marrone		4529 1952 Black core Anima nera
SIZES (mm) Misure		Price Prezzo		
	Ø 490	€ 101,00		
	Ø 590	€ 120,00		
	Ø 690	€ 158,00		
	Ø 790	€ 211,00		
	Ø 890	€ 266,00		
	Ø 990	€ 298,00		
	Ø 1190	€ 455,00		
R10 (standard) On request, same price / su richiesta, allo stesso prezzo: 	590x590	€ 120,00		
	690x690	€ 158,00		
	790x790	€ 211,00		
	890x890	€ 266,00		
R10 (standard) On request, same price / su richiesta, allo stesso prezzo: 	690x590	€ 142,00		
	750x650	€ 158,00		
	790x590	€ 175,00		
	790x690	€ 192,00		
	1090x690	€ 283,00 *		
	1190x790	€ 332,00 *		
	1290x790	€ 381,00 *		
	1350x790	€ 398,00 *		
	1590x790	€ 414,00 *		

* Price includes reinforcing bars / Il prezzo include i tubi di rinforzo

On request, customized sizes and radius angle can be manufactured / Su richiesta si possono produrre misure speciali e angoli a raggio speciale

Solid laminate / Stratificato



Metal threaded inserts included
Bussole incluse

COMPACT

mm 10

COP



Flat edge
Bordo piatto

Colours / Colori

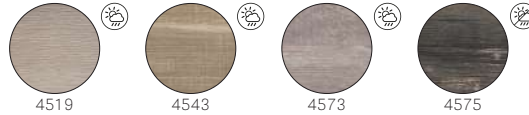

Brown core
Anima marrone

SIZES (mm) Misure

Price Prezzo

	Ø 490	€ 101,00
	Ø 590	€ 120,00
	Ø 690	€ 158,00
	Ø 790	€ 211,00
	Ø 890	€ 266,00
	Ø 990	€ 298,00
	Ø 1190	€ 455,00
R10 (standard)	590x590	€ 120,00
	690x690	€ 158,00
	790x790	€ 211,00
	890x890	€ 266,00
On request, same price / su richiesta, allo stesso prezzo:	690x590	€ 142,00
	750x650	€ 158,00
	790x590	€ 175,00
	790x690	€ 192,00
	1090x690	€ 283,00 *
	1190x790	€ 332,00 *
	1290x790	€ 381,00 *
	1350x790	€ 398,00 *
	1590x790	€ 414,00 *

* Price includes reinforcing bars / Il prezzo include i tubi di rinforzo

On request, customized sizes and radius angle can be manufactured / Su richiesta si possono produrre misure speciali e angoli a raggio speciale

Solid laminate / Stratificato



Metal threaded inserts included
Bussole incluse

COMPACT

mm 10

COP



Flat edge
Bordo piatto

Colours / Colori



4511



4517

Brown core
Anima marrone

SIZES (mm)
Misure

Price
Prezzo



Ø 490

€ 101,00

Ø 590

€ 120,00

Ø 690

€ 158,00

Ø 790

€ 211,00

Ø 890

€ 266,00

Ø 990

€ 298,00

Ø 1190

€ 455,00



R10 (standard)

590x590

€ 120,00

On request, same price / su richiesta, allo stesso prezzo:



690x690

€ 158,00

790x790

€ 211,00

890x890

€ 266,00



R10 (standard)

690x590

€ 142,00

750x650

€ 158,00

On request, same price / su richiesta, allo stesso prezzo:



790x590

€ 175,00

790x690

€ 192,00

1090x690

€ 283,00 *

1190x790

€ 332,00 *

1290x790

€ 381,00 *

1350x790

€ 398,00 *

1590x790

€ 414,00 *



For Stylus table bases
Per basamenti Stylus

590x590

€ 132,00

690x690

€ 175,00

790x790

€ 233,00

890x890

€ 293,00

* Price includes reinforcing bars / Il prezzo include i tubi di rinforzo

On request, customized sizes and radius angle can be manufactured / Su richiesta si possono produrre misure speciali e angoli a raggio speciale

Colours are indicative. All sizes and dimensions could change within the tolerance of ±5 mm
I colori sono indicativi. Le misure indicate possono variare nella tolleranza di ±5 mm

Solid laminate / Stratificato



Metal threaded inserts included
Bussole incluse

COMPACT mm 10		COMPACT mm 12		
COP Flat edge Bordo piatto		COI Chamfered edge Bordo inclinato	COM Round edge Bordo tondo	COP Flat edge Bordo piatto
Colours / Colori 3294		Colours / Colori 2810		











Black core
Anima nera

SIZES (mm) Misura		Price Prezzo	
	Ø 490	€ 101,00	€ 111,00
	Ø 590	€ 120,00	€ 133,00
	Ø 690	€ 158,00	€ 175,00
	Ø 790	€ 211,00	€ 233,00
	Ø 890	€ 266,00	€ 292,00
	Ø 990	€ 298,00	€ 344,00
	Ø 1190	€ 455,00	€ 524,00
 R10 (standard) On request, same price / su richiesta, allo stesso prezzo: 	590x590	€ 120,00	€ 133,00
	690x690	€ 158,00	€ 175,00
	790x790	€ 211,00	€ 233,00
	890x890	€ 266,00	€ 292,00
 R10 (standard) On request, same price / su richiesta, allo stesso prezzo: 	690x590	€ 142,00	€ 156,00
	750x650	€ 158,00	€ 175,00
	790x590	€ 175,00	€ 193,00
	790x690	€ 192,00	€ 211,00
	1090x690	€ 283,00 *	€ 311,00 *
	1190x790	€ 332,00 *	€ 364,00 *
	1290x790	€ 381,00 *	€ 420,00 *
	1350x790	€ 398,00 *	€ 439,00 *
1590x790	€ 414,00 *	€ 455,00 *	
 For Stylus table bases Per basamenti Stylus	590x590	-	€ 146,00
	690x690	-	€ 192,00
	790x790	-	€ 257,00
	890x890	-	€ 322,00

* Price includes reinforcing bars / Il prezzo include i tubi di rinforzo

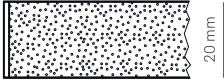







On request, customized sizes and radius angle can be manufactured / Su richiesta si possono produrre misure speciali e angoli a raggio speciale

Laminate / Laminato

		ABS EDGE Bordo ABS mm 20					
		BAI/20 White ABS edge Bordo ABS bianco	BAB/20 Ivory ABS edge Bordo ABS avorio	BAN/20 Black ABS edge Bordo ABS nero	BAW/20 Wenge ABS edge Bordo ABS wengè	BAR/20 Bleached oak ABS edge Bordo ABS rovere sbiancato	BAG/20 Grey ABS edge Bordo ABS grigio
		Colours / Colori	Colours / Colori	Colours / Colori	Colours / Colori	Colours / Colori	Colours / Colori
		 406_0020	 1813_244	 421	 312	 386	 263
		 Chipboard core Anima in truciolare					
SIZES (mm) Misure		Price Prezzo					
	Ø 590	€ 85,00					
	Ø 690	€ 114,00					
	Ø 790	€ 141,00					
	Ø 890	€ 175,00					
	Ø 990	€ 202,00					
	Ø 1190	€ 301,00					
	Ø 1290	€ 355,00					
	590x590	€ 59,00					
	690x690	€ 81,00					
	790x790	€ 103,00					
	890x890	€ 130,00					
	990x590	€ 98,00					
	1090x690	€ 125,00					
	1190x790	€ 154,00					
	1290x790	€ 284,00 *					









* Price includes reinforcing bars / Il prezzo include i tubi di rinforzo

Laminate / Laminato

		ABS EDGE Bordo ABS mm 20			
		BA4519/20	BA4529/20	BA4543/20	BA4573/20
		Colours / Colori	Colours / Colori	Colours / Colori	Colours / Colori
		 4519	 4529	 4543	 4573
		 Chipboard core Anima in truciolare			
SIZES (mm) Misure		Price Prezzo			
	Ø 590	€ 85,00			
	Ø 690	€ 114,00			
	Ø 790	€ 141,00			
	Ø 890	€ 175,00			
	Ø 990	€ 202,00			
	Ø 1190	€ 301,00			
	Ø 1290	€ 355,00			
	590x590	€ 59,00			
	690x690	€ 81,00			
	790x790	€ 103,00			
	890x890	€ 130,00			
	990x590	€ 98,00			
	1090x690	€ 125,00			
	1190x790	€ 154,00			
	1290x790	€ 284,00 *			







* Price includes reinforcing bars / Il prezzo include i tubi di rinforzo

Laminate / Laminato

		ABS EDGE Bordo ABS mm 20			
		BA4511/20	BA4512/20	BA4517/20	BA4575/20
		Colours / Colori	Colours / Colori	Colours / Colori	Colours / Colori
		 4511	 4512	 4517	 4575
		 20 mm Chipboard core Anima in truciolare			
SIZES (mm) Misure		Price Prezzo			
	Ø 590	€ 85,00			
	Ø 690	€ 114,00			
	Ø 790	€ 141,00			
	Ø 890	€ 175,00			
	Ø 990	€ 202,00			
	Ø 1190	€ 301,00			
	Ø 1290	€ 355,00			
	590x590	€ 59,00			
	690x690	€ 81,00			
	790x790	€ 103,00			
	890x890	€ 130,00			
	990x590	€ 98,00			
	1090x690	€ 125,00			
	1190x790	€ 154,00			
	1290x790	€ 284,00 *			

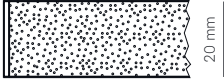
* Price includes reinforcing bars / Il prezzo include i tubi di rinforzo

Laminate / Laminato

		ABS EDGE Bordo ABS mm 20	
		BA_527/20	BA3294/20
		Colours / Colori	Colours / Colori
		 527	 3294
		 Chipboard core Anima in truciolare	
SIZES (mm) Misure		Price Prezzo	
	Ø 590	€ 85,00	
	Ø 690	€ 114,00	
	Ø 790	€ 141,00	
	Ø 890	€ 175,00	
	Ø 990	€ 202,00	
	Ø 1190	€ 301,00	
	Ø 1290	€ 355,00	
	590x590	€ 59,00	
	690x690	€ 81,00	
	790x790	€ 103,00	
	890x890	€ 130,00	
	990x590	€ 98,00	
	1090x690	€ 125,00	
	1190x790	€ 154,00	
	1290x790	€ 284,00 *	

* Price includes reinforcing bars / Il prezzo include i tubi di rinforzo

Laminate / Laminato



ABS EDGE Bordo ABS mm 30

BAI/30	BAB/30	BAN/30	BAW/30	BAR/30	BAG/30
White ABS edge Bordo ABS bianco	Ivory ABS edge Bordo ABS avorio	Black ABS edge Bordo ABS nero	Wenge ABS edge Bordo ABS wengè	Bleached oak ABS edge Bordo ABS rovere sbiancato	Grey ABS edge Bordo ABS grigio
Colours / Colori	Colours / Colori	Colours / Colori	Colours / Colori	Colours / Colori	Colours / Colori
					
406_0020	1813_244	421	312	386	263

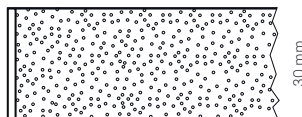







Chipboard core
Anima in truciolare

SIZES (mm) Misure





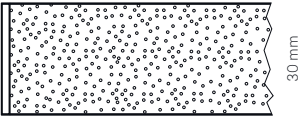

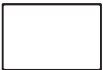
Price Prezzo

	Ø 590	€ 112,00
	Ø 690	€ 150,00
	Ø 790	€ 197,00
	Ø 890	€ 245,00
	Ø 990	€ 302,00
	Ø 1190	€ 471,00
	Ø 1290	€ 554,00
	590x590	€ 68,00
	690x690	€ 90,00
	790x790	€ 117,00
	890x890	€ 147,00
	990x590	€ 111,00
	1090x690	€ 167,00
	1190x790	€ 175,00
	1290x790	€ 202,00
	1390x790	€ 202,00
	1590x790	€ 233,00
	1590x890	€ 266,00





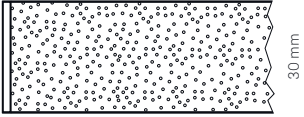

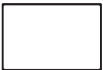
Laminate / Laminato

		ABS EDGE Bordo ABS mm 30			
		BA4519/30	BA4529/30	BA4543/30	BA4573/30
		Colours / Colori	Colours / Colori	Colours / Colori	Colours / Colori
		 4519	 4529	 4543	 4573
		 Chipboard core Anima in truciolare			
SIZES (mm) Misure		Price Prezzo			
	Ø 590	€ 112,00			
	Ø 690	€ 150,00			
	Ø 790	€ 197,00			
	Ø 890	€ 245,00			
	Ø 990	€ 302,00			
	Ø 1190	€ 471,00			
	Ø 1290	€ 554,00			
	590x590	€ 68,00			
	690x690	€ 90,00			
	790x790	€ 117,00			
	890x890	€ 147,00			
	990x590	€ 111,00			
	1090x690	€ 167,00			
	1190x790	€ 175,00			
	1290x790	€ 202,00			
	1390x790	€ 202,00			
	1590x790	€ 233,00			
	1590x890	€ 266,00			

Laminate / Laminato

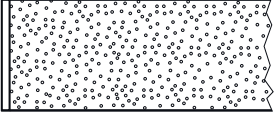







		ABS EDGE Bordo ABS mm 30			
		BA4511/30	BA4512/30	BA4517/30	BA4575/30
		Colours / Colori	Colours / Colori	Colours / Colori	Colours / Colori
		 4511	 4512	 4517	 4575
		 Chipboard core Anima in truciolare			
SIZES (mm) Misure		Price Prezzo			
	Ø 590	€ 112,00			
	Ø 690	€ 150,00			
	Ø 790	€ 197,00			
	Ø 890	€ 245,00			
	Ø 990	€ 302,00			
	Ø 1190	€ 471,00			
	Ø 1290	€ 554,00			
	590x590	€ 68,00			
	690x690	€ 90,00			
	790x790	€ 117,00			
	890x890	€ 147,00			
	990x590	€ 111,00			
	1090x690	€ 167,00			
	1190x790	€ 175,00			
	1290x790	€ 202,00			
	1390x790	€ 202,00			
	1590x790	€ 233,00			
	1590x890	€ 266,00			

Laminate / Laminato

		ABS EDGE Bordo ABS mm 30	
		BA_527/30	BA3294/30
		Colours / Colori  527	Colours / Colori  3294
		 Chipboard core Anima in truciolare	
SIZES (mm) Misure		Price Prezzo	
	Ø 590	€ 112,00	
	Ø 690	€ 150,00	
	Ø 790	€ 197,00	
	Ø 890	€ 245,00	
	Ø 990	€ 302,00	
	Ø 1190	€ 471,00	
	Ø 1290	€ 554,00	
	590x590	€ 68,00	
	690x690	€ 90,00	
	790x790	€ 117,00	
	890x890	€ 147,00	
	990x590	€ 111,00	
	1090x690	€ 167,00	
	1190x790	€ 175,00	
	1290x790	€ 202,00	
	1390x790	€ 202,00	
	1590x790	€ 233,00	
	1590x890	€ 266,00	

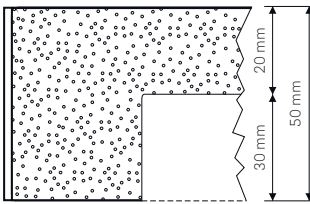
Laminate / Laminato







		ABS EDGE Bordo ABS mm 50				
		BAI/50 White ABS edge Bordo ABS bianco	BAB/50 Ivory ABS edge Bordo ABS avorio	BAN/50 Black ABS edge Bordo ABS nero	BAW/50 Wenge ABS edge Bordo ABS wengè	BAR/50 Bleached oak ABS edge Bordo ABS rovere sbiancato
		Colours / Colori  406_0020	Colours / Colori  1813_244	Colours / Colori  421	Colours / Colori  312	Colours / Colori  386
		 <p>Chipboard core Anima in truciolare</p>				
SIZES (mm) Misure		Price Prezzo				
	Ø 590	€ 86,00				
	Ø 690	€ 120,00				
	Ø 790	€ 156,00				
	Ø 890	€ 197,00				
	Ø 990	€ 244,00				
	Ø 1190	€ 397,00				
	Ø 1290	€ 429,00				
	590x590	€ 81,00				
	690x690	€ 111,00				
	790x790	€ 143,00				
	890x890	€ 172,00				
	1190x790	€ 197,00				
	1390x790	€ 232,00				
	1590x790	€ 283,00				
	1590x890	€ 307,00				

Laminate / Laminato



ABS EDGE
Bordo ABS
mm 50

BA4519/50	BA4529/50	BA4543/50	BA4573/50
Colours / Colori	Colours / Colori	Colours / Colori	Colours / Colori
			
4519	4529	4543	4573

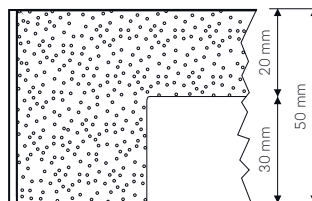

Chipboard core
Anima in truciolare

SIZES (mm) Misure		Price Prezzo
	Ø 590	€ 86,00
	Ø 690	€ 120,00
	Ø 790	€ 156,00
	Ø 890	€ 197,00
	Ø 990	€ 244,00
	Ø 1190	€ 397,00
	Ø 1290	€ 429,00
	590x590	€ 81,00
	690x690	€ 111,00
	790x790	€ 143,00
	890x890	€ 172,00
	1190x790	€ 197,00
	1390x790	€ 232,00
	1590x790	€ 283,00
	1590x890	€ 307,00

Colours are indicative. All sizes and dimensions could change within the tolerance of ±5 mm
I colori sono indicativi. Le misure indicate possono variare nella tolleranza di ±5 mm

Laminate / Laminato



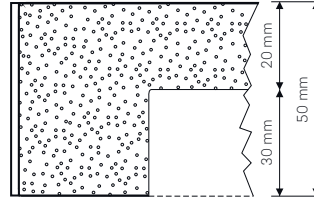

ABS EDGE
Bordo ABS
mm 50

BA4511/50	BA4512/50	BA4517/50	BA4575/50
Colours / Colori	Colours / Colori	Colours / Colori	Colours / Colori
			
4511	4512	4517	4575



Chipboard core
Anima in truciolare

SIZES (mm) Misure		Price Prezzo
	Ø 590	€ 86,00
	Ø 690	€ 120,00
	Ø 790	€ 156,00
	Ø 890	€ 197,00
	Ø 990	€ 244,00
	Ø 1190	€ 397,00
	Ø 1290	€ 429,00
	590x590	€ 81,00
	690x690	€ 111,00
	790x790	€ 143,00
	890x890	€ 172,00
	1190x790	€ 197,00
	1390x790	€ 232,00
	1590x790	€ 283,00
	1590x890	€ 307,00

Laminate / Laminato



ABS EDGE
Bordo ABS
mm 50

BA_527/50

BA3294/50

Colours / Colori

Colours / Colori



527

3294

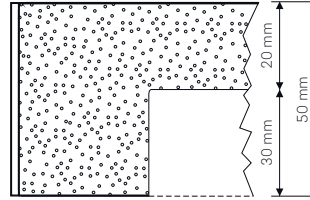







Chipboard core
Anima in truciolare

SIZES (mm)
Misure

Price
Prezzo

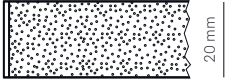
	Ø 590	€ 86,00
	Ø 690	€ 120,00
	Ø 790	€ 156,00
	Ø 890	€ 197,00
	Ø 990	€ 244,00
	Ø 1190	€ 397,00
	Ø 1290	€ 429,00
	590x590	€ 81,00
	690x690	€ 111,00
	790x790	€ 143,00
	890x890	€ 172,00
	1190x790	€ 197,00
	1390x790	€ 232,00
	1590x790	€ 283,00
	1590x890	€ 307,00

Laminate / Laminato

		ABS EDGE Bordo ABS mm 20	
		BAO/20 Brass ABS edge Bordo ABS ottonato	
		Colours / Colori  Shiny / Lucido	
		 Chipboard core Anima in truciolare	
SIZES (mm) Misure		Price Prezzo	
	Ø 590	€ 110,00	
	Ø 690	€ 138,00	
	Ø 790	€ 164,00	
	Ø 890	€ 197,00	
	Ø 990	€ 227,00	
	Ø 1190	€ 328,00	
	Ø 1290	€ 433,00	
 R50	590x590	€ 110,00	
	690x690	€ 138,00	
	790x790	€ 164,00	
	890x890	€ 197,00	
 R50	990x590	€ 154,00	
	1090x690	€ 227,00	
	1190x790	€ 227,00	
	1290x790	€ 349,00 *	

* Price includes reinforcing bars / Il prezzo include i tubi di rinforzo

Laminate / Laminato



ABS EDGE

Bordo ABS
mm 30

BAO/30

Brass ABS edge
Bordo ABS ottonato

Colours / Colori

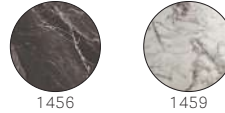

Shiny / Lucido

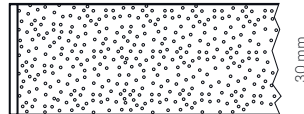
Chipboard core
Anima in truciolareSIZES (mm)
MisurePrice
Prezzo

	Ø 590	€ 141,00
	Ø 690	€ 176,00
	Ø 790	€ 206,00
	Ø 890	€ 255,00
	Ø 990	€ 302,00
	Ø 1190	€ 497,00
	Ø 1290	€ 582,00
	590x590	€ 141,00
	690x690	€ 175,00
	790x790	€ 206,00
	890x890	€ 255,00
	990x590	€ 173,00
	1090x690	€ 301,00
	1190x790	€ 301,00
	1290x790	€ 312,00
	1390x790	€ 312,00
	1590x790	€ 328,00
	1590x890	€ 381,00

Laminate / Laminato



ABS EDGE

Bordo ABS
mm 50

BAO/50

Brass ABS edge
Bordo ABS ottonato

Colours / Colori



1456



1459

Shiny / Lucido

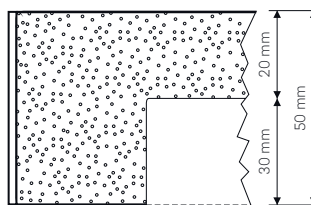

Chipboard core
Anima in truciolare

SIZES (mm)
Misure

Price
Prezzo

SIZES (mm) Misure		Price Prezzo
	Ø 590	€ 154,00
	Ø 690	€ 193,00
	Ø 790	€ 216,00
	Ø 890	€ 266,00
	Ø 990	€ 324,00
	Ø 1190	€ 431,00
	Ø 1290	€ 470,00
	590x590	€ 154,00
	690x690	€ 193,00
	790x790	€ 216,00
	890x890	€ 266,00
	1190x790	€ 327,00
	1390x790	€ 349,00
	1590x790	€ 406,00
	1590x890	€ 431,00



LINOLEUM

mm 20

LMP

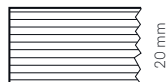

Flat edge
Bordo piatto



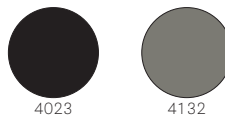







Colours / Colori

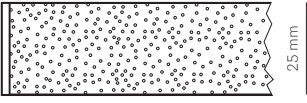

Plywood core
Anima in multistrati

SIZES (mm) Misure		Price Prezzo
	Ø 490	€ 192,00
	Ø 590	€ 233,00
	Ø 690	€ 283,00
	Ø 790	€ 340,00
	Ø 890	€ 414,00
	Ø 990	€ 514,00
	590x590	€ 233,00
	690x690	€ 283,00
	790x790	€ 340,00
	890x890	€ 414,00
	1090x690	€ 414,00
	1190x790	€ 497,00
	1290x790	€ 530,00
	1350x790	€ 563,00
	1590x790	€ 637,00

Melamine / Nobilitato

		ABS EDGE Bordo ABS mm 25					
		BAI	W1200	F187	H1387	H3332	H3349
		Colours / Colori	Colours / Colori	Colours / Colori	Colours / Colori	Colours / Colori	Colours / Colori
							
							
		Chipboard core Anima in truciolare					
SIZES (mm) Misure		Price Prezzo					
	Ø 595	€ 68,00					
	Ø 695	€ 84,00					
	Ø 795	€ 107,00					
	Ø 895	€ 133,00					
	Ø 995	€ 171,00					
	Ø 1195	€ 260,00					
	Ø 1295	€ 328,00					
	Ø 1595	€ 540,00					
	Ø 1795	€ 912,00					
	595x595	€ 62,00					
	695x695	€ 75,00					
	795x795	€ 91,00					
	895x895	€ 114,00					
	995x595	€ 98,00					
	1095x695	€ 127,00					
	1195x795	€ 137,00					
	1295x795	€ 156,00					
	1395x795	€ 156,00					
	1595x795	€ 177,00					

Stainless steel / Inox



STAINLESS STEEL
Inox
mm 12

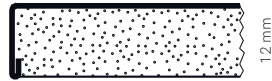

Flat edge
Bordo piatto

Colours / Colori



Raised finish / Inox grano di riso
Stainless steel AISI 304 / Acciaio inox AISI 304

Waterproof MDF core
Anima in MDF idrofugo

SIZES (mm) Misure		Item Articolo	Price Prezzo
	Ø 585	D_60INOX	€ 142,00
	700x700	_70X70INOX	€ 206,00

Steel / Lamiera



STEEL
Lamiera
mm 12

L



Flat edge
Bordo piatto







Colours / Colori



Waterproof MDF core
Anima in MDF idrofugo

SIZES (mm) Misure		Item Articolo	Price Prezzo
	Ø 585	D60L	€ 195,00
	Ø 700	D70L	€ 211,00
	582x582	_60X60L	€ 195,00
	700x700	_70X70L	€ 211,00
	800x800	_80X80L	€ 258,00

Tempered glass / Vetro temperato

		CLEAR TRANSPARENT Trasparente		FROSTED Acidato		BLACK LACQUERED GLASS Vetro laccato nero		WHITE LACQUERED EXTRA-CLEAR GLASS Extra-light laccato bianco	
		TRA		SAT		NER		BIA	
		Colours / Colori		Colours / Colori		Colours / Colori		Colours / Colori	
		 TRA		 SAT		 NER		 BIA	
									
SIZES (mm) Misure		Item Articolo	Price Prezzo	Item Articolo	Price Prezzo	Item Articolo	Price Prezzo	Item Articolo	Price Prezzo
	Ø 600 h 10mm	D60 TRA 4011	€ 153,00	D60 SAT 4011	€ 195,00	D60 NER 4011	€ 206,00	D60 BIA 4011	€ 258,00
	Ø 700 h 10mm	D70 TRA 4011	€ 169,00	D70 SAT 4011	€ 203,00	D70 NER 4011	€ 249,00	D70 BIA 4011	€ 279,00
	Ø 900 h 10mm	D90 TRA 4011	€ 225,00	-	-	D90 NER 4013	€ 381,00	D90 BIA 4011	€ 398,00
	Ø 1300 h 12mm	D130 TRA 4013	€ 734,00	-	-	-	-	-	-
	600x600 h 10mm	-	-	-	-	_60X60 NER 4011	€ 216,00	-	-

The stainless steel plate glued to the glass top is suitable for table bases with round tube Ø76 - Ø60 - Ø50 and column Ø90 - Elliot and Stylus excluded
La piastra in acciaio inox incollata al ripiano in vetro è adatta per basamenti con tubo rotondo Ø76 - Ø60 - Ø50 e colonna Ø90 - Escluso Elliot e Stylus

Tempered glass according to UNI EN ISO 12150
Vetro temperato secondo le normative EN ISO 12150

Prices are valid for supply with our table bases only
I prezzi indicati sono validi solo in caso di fornitura con i nostri basamenti

Colours are indicative.
I colori sono indicativi.

Gres



GRES

mm 10

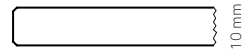
Flat edge
Bordo piatto

Colours / Colori



WFN

White Fossil Natural



GFN

Grey Fossil Natural



IDN

Ivory Dust Natural

SIZES (mm) Misure		Item Articolo	Price Prezzo
	Ø 590	D_59 GRES WFN/GFN/IDN	€ 341,00 *
	Ø 690	D_69 GRES WFN/GFN/IDN	€ 400,00 *
	Ø 790	D_79 GRES WFN/GFN/IDN	€ 413,00 *
	590x590	_59X59 GRES WFN/GFN/IDN	€ 341,00 *
	690x690	_69X69 GRES WFN/GFN/IDN	€ 400,00 *
	790x790	_79X79 GRES WFN/GFN/IDN	€ 413,00 *

* Price includes a solid laminate board / Il prezzo include un supporto in stratificato

Customer has to take care of the fixing of gres top to the bases by silicone
L'incollaggio dei piani in gres ai basamenti mediante silicone e' a cura del cliente

Colours are indicative. All sizes and dimensions could change within the tolerance of ±5 mm
I colori sono indicativi. Le misure indicate possono variare nella tolleranza di ±5 mm

Quartz stone / Quarzo



QUARTZ STONE

Quarzo
mm 20

QRZ/20

Flat edge
Bordo piatto

Colours / Colori



GR - Grey / Grigio



AV - Ivory / Avorio

SIZES (mm) Misure		Item Articolo	Price Prezzo
	Ø 500	D_50 QRZ 20	€ 350,00
	Ø 590	D_59 QRZ 20	€ 452,00
	Ø 690	D_69 QRZ 20	€ 548,00
	Ø 790	D_79 QRZ 20	€ 888,00 *
	600x600	_60X60 QRZ 20	€ 452,00
	690x690	_69X69 QRZ 20	€ 574,00 *
	790x790	_79X79 QRZ 20	€ 888,00 *
	900x900	_90X90 QRZ 20	€ 948,00 *
	1200x690	_120X69 QRZ 20	€ 953,00 *
	1200x790	_120X79 QRZ 20	€ 970,00 *

* Price includes a solid laminate board / Il prezzo include un supporto in stratificato

Customer has to take care of the fixing of quartz stone top to the bases by silicone
L'incollaggio dei piani in quarzo ai basamenti mediante silicone e' a cura del clienteColours are indicative. All sizes and dimensions could change within the tolerance of ±5 mm
I colori sono indicativi. Le misure indicate possono variare nella tolleranza di ±5 mm

Marble / Marmo



MARBLE

Marmo
mm 20Flat edge
Bordo piatto

Colours / Colori

MGC
Grigio CarnicoMED
Emperador DarkMVG
Verde Guatemala

Matt / Opaco

SIZES (mm) Misure		Item Articolo	Price Prezzo
	Ø 600	D60 BP MGC/MED/MVG	€ 491,00
	Ø 700	D70 BP MGC/MED/MVG	€ 626,00
	Ø 800	D80 BP MGC/MED/MVG	€ 777,00 *
	Ø 900	D90 BP MGC/MED/MVG	€ 944,00 *
	600x600	60X60 BP MGC/MED/MVG	€ 491,00
	700x700	70X70 BP MGC/MED/MVG	€ 643,00 *
	800x800	80X80 BP MGC/MED/MVG	€ 777,00 *
	900x900	90X90 BP MGC/MED/MVG	€ 944,00 *

* Price includes a solid laminate board / Il prezzo include un supporto in stratificato

Customer has to take care of the fixing of marble and granite top to the bases by silicone
L'incollaggio dei piani in marmo e granito ai basamenti mediante silicone e' a cura del cliente

Marble / Marmo



BIANCO CARRARA

mm 20

MBC



Flat edge
Bordo piatto

MBC



Round edge
Bordo tondo

Colours / Colori



Glossy painted
Verniciato lucido

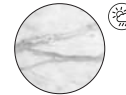

Matt smoothed
Levigato opaco



SIZES (mm) Misure		Item Articolo	Price Prezzo	Item Articolo	Price Prezzo
	Ø 600	D60 BP MBC	€ 327,00	D60 BT MBC	€ 444,00
	Ø 700	D70 BP MBC	€ 383,00	D70 BT MBC	€ 520,00
	Ø 800	D80 BP MBC	€ 479,00 *	D80 BT MBC	€ 637,00 *
	Ø 900	D90 BP MBC	€ 565,00 *	D90 BT MBC	€ 741,00 *
	600x600	60X60 BP MBC	€ 327,00	60X60 BT MBC	€ 444,00
	700x700	70X70 BP MBC	€ 409,00 *	70X70 BT MBC	€ 546,00 *
	800x800	80X80 BP MBC	€ 479,00 *	80X80 BT MBC	€ 637,00 *
	900x900	90X90 BP MBC	€ 565,00 *	90X90 BT MBC	€ 741,00 *

* Price includes a solid laminate board / Il prezzo include un supporto in stratificato

Customer has to take care of the fixing of marble and granite top to the bases by silicone
L'incollaggio dei piani in marmo e granito ai basamenti mediante silicone e' a cura del cliente

Colours are indicative. All sizes and dimensions could change within the tolerance of ±5 mm
I colori sono indicativi. Le misure indicate possono variare nella tolleranza di ±5 mm

Composite marble / Agglomerato di marmo



COMPOSITE MARBLE
Agglomerato di marmo
mm 12



Bevelled edge
Bordo smussato

Colours / Colori



MFP
Fior di pesco



MBR
Breccia aurora



MPR
Perlato royal

Matt / Opaco

SIZES (mm) Misure		Item Articolo	Price Prezzo
	Ø 600	D60 BSG MFP/MBR/MPR	€ 429,00
	Ø 700	D70 BSG MFP/MBR/MPR	€ 608,00 *
	Ø 800	D80 BSG MFP/MBR/MPR	€ 734,00 *
	Ø 900	D90 BSG MFP/MBR/MPR	€ 875,00 *
	600x600	60X60 BSG MFP/MBR/MPR	€ 455,00 *
	700x700	70X70 BSG MFP/MBR/MPR	€ 643,00 *
	800x800	80X80 BSG MFP/MBR/MPR	€ 766,00 *
	900x900	90X90 BSG MFP/MBR/MPR	€ 875,00 *

* Price includes a solid laminate board / Il prezzo include un supporto in stratificato

Customer has to take care of the fixing of marble and granite top to the bases by silicone
L'incollaggio dei piani in marmo e granito ai basamenti mediante silicone e' a cura del cliente

Composite marble / Agglomerato di marmo



COMPOSITE MARBLE
Agglomerato di marmo
mm 12



Bevelled edge
Bordo smussato

Colour / Colore



MRL
Rosso Levanto

Matt / Opaco

SIZES (mm) Misure		Item Articolo	Price Prezzo
	Ø 600	D60 BSG MRL	€ 475,00
	Ø 700	D70 BSG MRL	€ 676,00 *
	Ø 800	D80 BSG MRL	€ 821,00 *
	Ø 900	D90 BSG MRL	€ 985,00 *
	600x600	60X60 BSG MRL	€ 501,00 *
	700x700	70X70 BSG MRL	€ 715,00 *
	800x800	80X80 BSG MRL	€ 858,00 *
	900x900	90X90 BSG MRL	€ 985,00 *

* Price includes a solid laminate board / Il prezzo include un supporto in stratificato

Customer has to take care of the fixing of marble and granite top to the bases by silicone
L'incollaggio dei piani in marmo e granito ai basamenti mediante silicone e' a cura del cliente

Granite / Granito



NERO AFRICA

mm 20

GNA

Flat edge
Bordo piatto

GNA

Round edge
Bordo tondo

Colours / Colori





GNA

SIZES (mm) Misure		Item Articolo	Price Prezzo	Item Articolo	Price Prezzo
	Ø 600	D60 BP GNA	€ 429,00	D60 BT GNA	€ 624,00
	Ø 700	D70 BP GNA	€ 531,00	D70 BT GNA	€ 783,00
	Ø 800	D80 BP GNA	€ 679,00 *	D80 BT GNA	€ 946,00 *
	Ø 900	D90 BP GNA	€ 810,00 *	D90 BT GNA	€ 1.113,00 *
	600x600	60X60 BP GNA	€ 432,00	60X60 BT GNA	€ 624,00
	700x700	70X70 BP GNA	€ 557,00 *	70X70 BT GNA	€ 809,00 *
	800x800	80X80 BP GNA	€ 679,00 *	80X80 BT GNA	€ 946,00 *
	900x900	90X90 BP GNA	€ 810,00 *	90X90 BT GNA	€ 1.113,00 *

* Price includes a solid laminate board / Il prezzo include un supporto in stratificato

Customer has to take care of the fixing of marble and granite top to the bases by silicone
L'incollaggio dei piani in marmo e granito ai basamenti mediante silicone e' a cura del cliente

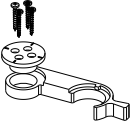
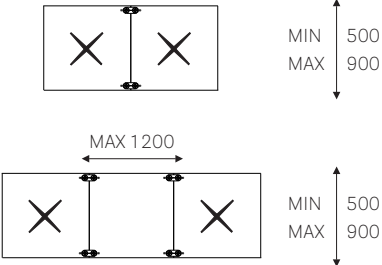
Colours are indicative. All sizes and dimensions could change within the tolerance of ±5 mm
I colori sono indicativi. Le misure indicate possono variare nella tolleranza di ±5 mm

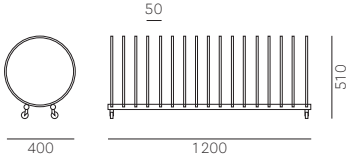
CODE Codice	TECHNICAL DETAILS Dettagli tecnici	FINISH Finitura	SIZES Misure	PRICE Prezzo
 <p>Linking devices for table tops Ganci per ripiani</p> <p>3350</p> <p>For laminate and melamine tops Per ripiani in laminato e nobilitato</p>	 <p>Not suitable for tops thickness 50 mm Non adatto per ripiani spessore 50 mm</p>  <p>MIN 500 MAX 900</p> <p>MAX 1200</p> <p>MIN 500 MAX 900</p>	<p>NYLON</p>	<p>165x51</p>	<p>€ 21,00</p>
<p>3350_STR</p> <p>For solid laminate tops, applicable from 10 mm thickness and flat edge Per ripiani in stratificato, a partire dallo spessore 10 mm con bordo piatto</p>	 <p>MIN 500 MAX 900</p>	<p>NYLON</p>	<p>165x51</p>	<p>€ 21,00</p>
<p>TROLLEY Carrello</p> 	 <p>Capacity; n.16 tops Capacità; n.16 ripiani</p>	<p>WHITE POWDER COATED Verniciato bianco</p>	<p>1200x450</p>	<p>€ 158,00</p>

BLUME SYSTEM

Bedside table and libraries system / Comodino e sistema di librerie



Item Articolo	Frame Telaio Sizes Dimensioni	Finish Finitura	Solid laminate top included Incluso ripiano in stratificato					Composite marble top included Incluso ripiano in agglomerato di marmo	
			CFC_BI (mm 10)	FNP_NE (mm 10)	COP_3471 (mm 10)	FNP_3452 (mm 10)	FNP_3455 (mm 10)	MFP, MBR, MPR, MRL (mm 12)	
BLS2_49X32X52	490X320X515h	POWDER COATED Verniciato	€ 650,00	€ 650,00	€ 663,00	€ 663,00	€ 728,00	€ 998,00	
		OA - BS - GG	€ 702,00	€ 702,00	€ 715,00	€ 715,00	€ 780,00	€ 1.050,00	
BLS3_105X32X89	1045X320X885h	POWDER COATED Verniciato	€ 1.157,00	€ 1.157,00	€ 1.209,00	€ 1.209,00	€ 1.404,00	€ 2.077,00	
		OA - BS - GG	€ 1.209,00	€ 1.209,00	€ 1.261,00	€ 1.261,00	€ 1.456,00	€ 2.129,00	
BLS4_105X32X126	1045X320X1255h	POWDER COATED Verniciato	€ 1.495,00	€ 1.495,00	€ 1.547,00	€ 1.547,00	€ 1.820,00	€ 2.662,00	
		OA - BS - GG	€ 1.547,00	€ 1.547,00	€ 1.599,00	€ 1.599,00	€ 1.872,00	€ 2.714,00	
BLS3_129X32X89	1290X320X885h	POWDER COATED Verniciato	€ 1.287,00	€ 1.287,00	€ 1.339,00	€ 1.339,00	€ 1.599,00	€ 2.207,00	
		OA - BS - GG	€ 1.339,00	€ 1.339,00	€ 1.391,00	€ 1.391,00	€ 1.651,00	€ 2.259,00	
BLS4_129X32X126	1290X320X1255h	POWDER COATED Verniciato	€ 1.664,00	€ 1.664,00	€ 1.729,00	€ 1.729,00	€ 2.067,00	€ 2.844,00	
		OA - BS - GG	€ 1.716,00	€ 1.716,00	€ 1.781,00	€ 1.781,00	€ 2.119,00	€ 2.896,00	
BLS3_189X32X89	1890X320X885h	POWDER COATED Verniciato	€ 2.145,00	€ 2.145,00	€ 2.223,00	€ 2.223,00	€ 2.587,00	€ 3.325,00	
		OA - BS - GG	€ 2.223,00	€ 2.223,00	€ 2.301,00	€ 2.301,00	€ 2.665,00	€ 3.403,00	
BLS4_189X32X126	1890X320X1255h	POWDER COATED Verniciato	€ 2.782,00	€ 2.782,00	€ 2.886,00	€ 2.886,00	€ 3.380,00	€ 4.326,00	
		OA - BS - GG	€ 2.860,00	€ 2.860,00	€ 2.964,00	€ 2.964,00	€ 3.458,00	€ 4.404,00	

TECHNICAL DETAILS / Dettagli tecnici

Item BLS2_49X32X52

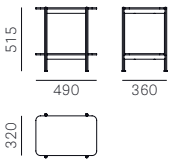

Solid laminate
Stratificato



Composite marble
Agglomerato di marmo



Item BLS3_105X32X89

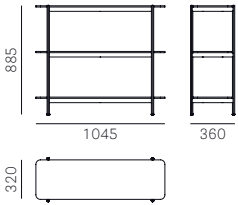

Maximum capacity 74 Kg/top evenly distributed
Portata massima 74 Kg/ripiano uniformemente distribuiti

Item BLS4_105X32X126

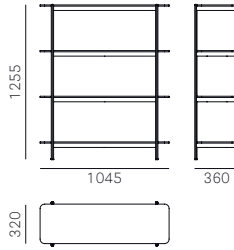

Maximum capacity 74 Kg/top evenly distributed
Portata massima 74 Kg/ripiano uniformemente distribuiti

Item BLS3_129X32X89

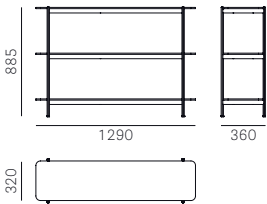

Maximum capacity 90 Kg/top evenly distributed
Portata massima 90 Kg/ripiano uniformemente distribuiti

Item BLS4_129X32X126

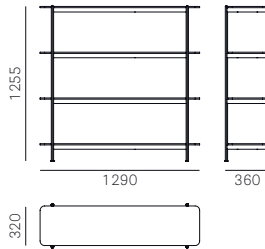

Maximum capacity 90 Kg/top evenly distributed
Portata massima 90 Kg/ripiano uniformemente distribuiti

Item BLS3_189X32X89

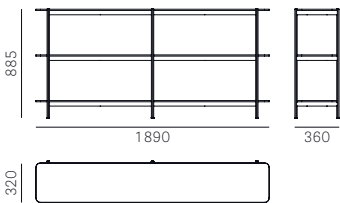

Maximum capacity 133 Kg/top evenly distributed
Portata massima 133 Kg/ripiano uniformemente distribuiti

Item BLS4_189X32X126

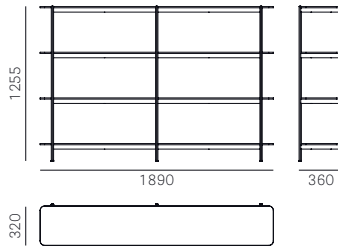

Maximum capacity 133 Kg/top evenly distributed
Portata massima 133 Kg/ripiano uniformemente distribuiti

Solid laminate top finishes

Finiture ripiano in stratificato

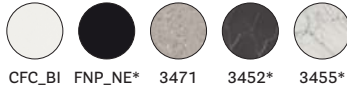

*Anti-fingerprint finish
Finitura anti-impronta

Composite marble top finishes

Finiture ripiano in agglomerato di marmo

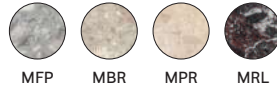

Frame finishes

Finiture telaio



For powder coated frame in other standard colours, see at page 282-283
Per telaio verniciato in altri colori standard, vedere a pagina 282-283

BOXIE

Storage system / Sistema contenitore



Item Articolo	Frame Telaio	Sizes Dimensioni	Polypropylene tops and drawers Ripiani e cassetti in polipropilene
BXL_2C	POWDER COATED Verniciato	515X530X460h	€ 379,00
BXL_1C			€ 363,00
BXM_3C	POWDER COATED Verniciato	515X530X630h	€ 472,00
BXM_2C			€ 457,00
BXH_4C	POWDER COATED Verniciato	515X530X800h	€ 583,00
BXH_3C			€ 567,00

TECHNICAL DETAILS / Dettagli tecnici

Item BXL_2C

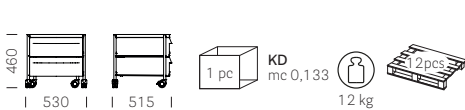

Item BXM_3C

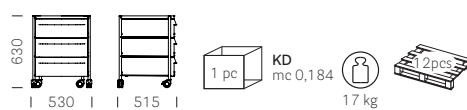

Item BXH_4C

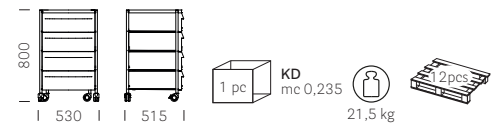

Item BXL_1C



Item BXM_2C

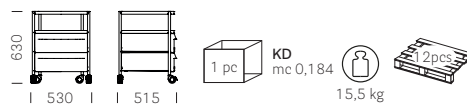

Item BXH_3C

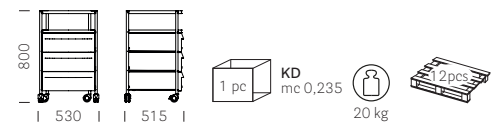

Polypropylene and powder coated steel frame colours



WOW

Low table storage / Tavolo basso contenitore



Item Articolo	Sizes Dimensioni	Finish Finitura	Price Prezzo
470	Ø 660 h290	Polyethylene Polietilene	€ 188,00
472	Ø 630 sp 8	Methacrylate Metacrilato	€ 173,00
480	Ø 400 h450	Polyethylene Polietilene	€ 119,00
482	Ø 375 sp 8	Methacrylate Metacrilato	€ 68,00
486	Ø 400 h 490	Polyethylene Polietilene Methacrylate Metacrilato	€ 455,00



Item 480

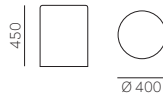

Item 482



Item 470

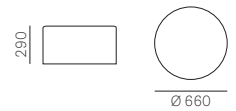

Item 472

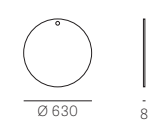

Polyethylene colours Colori polietilene



Methacrylate colours Colori metacrilato



WOW LUMINOUS

Charger for electrical mobile devices / Carica per dispositivi elettrici portatili

Item 486

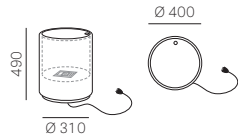

LED 24W 4000°K
CE IP20

Polyethylene colours Colori polietilene



Methacrylate colours Colori metacrilato



FLAG

Coat stand / Appendiabiti



Frame
Telaio

Item Articolo	Base Base	Height Altezza	Column Colonna	Finish Finitura	Polypropylene colours Colori polipropilene	Price Prezzo
5145	Ø 400	1730	Ø 35	BI100 - NERO - BE200 AR400 - VE500 - RA200	BI - NE - BE AR - VE - RA	€ 236,00
5144B				BI100 - NERO - BE200 AR400 - VE500 - RA200	BI - NE - BE AR - VE - RA	€ 236,00

TECHNICAL DETAILS / Dettagli tecnici

Item 5145

Item 5144B

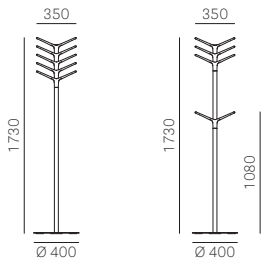

9,5 kg

Polypropylene and powder coated steel frame colours

Colori polipropilene e struttura in acciaio verniciato

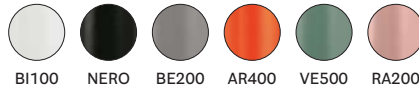
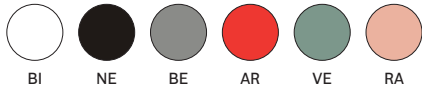

FLAG wall

Coat hanger / Appendiabiti



Frame
Telaio

Item Articolo	Finish Finitura	Polypropylene colours Colori polipropilene	Price Prezzo
5150W4	BI100 - NERO - BE200 - AR400	BI - NE - BE - AR	€ 99,00
5150W8			€ 164,00
5150W12			€ 229,00

TECHNICAL DETAILS / Dettagli tecnici

Item 5150W4

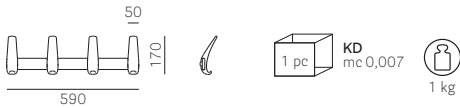

Item 5150W8

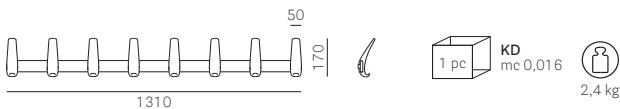

Item 5150W12

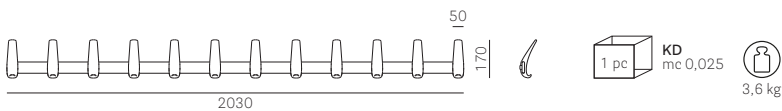

Polypropylene and powder coated steel frame colours

Colori polipropilene e struttura in acciaio verniciato



RAY

Coat stand / Appendiabiti



Frame
Telaio

Item Articolo	Base Base	Height Altezza	Column Colonna	Finish Finitura	Price Prezzo
5166	Ø 400	1715	Ø 35	POWDER COATED Verniciato	€ 520,00

TECHNICAL DETAILS / Dettagli tecnici

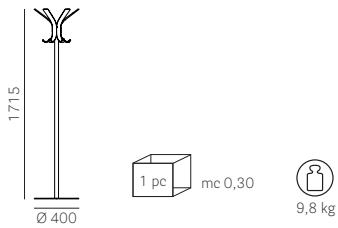

Ash colours
Colori frassino



VOILA'

Coat stand / Appendiabiti



Frame
Telaio

Item Articolo	Base Base	Height Altezza	Column Colonna	Feet Piedini	Finish Finitura	Price Prezzo
5130	Ø 400	1720	Ø 50	Art. 1001	AC	€ 389,00

TECHNICAL DETAILS / Dettagli tecnici

Item 5130

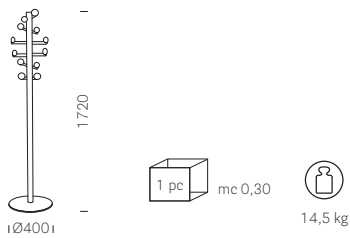

Methacrylate hooks colours
Colori terminali in metacrilato

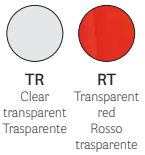

HEVEA

Pot-holder and ice bucket / Portavasi e portagiaccio



Frame
Telaio

Item Articolo	Base Base	Height Altezza	Column Colonna	Finish Finitura	Polypropylene colours Colori polipropilene	Price Prezzo
5181	Ø 400	1750	Ø 35	BI100 - TE - VE600 - NERO	BI - TE - VE - NE	€ 410,00
5182	Ø 340	850	Ø 35	BI100 - NERO	BI - NE	€ 176,00
5183		1750	3x Ø 35	BI100 - TE - VE600 - NERO	BI - TE - VE - NE	€ 1.105,00
K_5180_1 Kit only: 1 pot + 1 hook Solo kit: 1 vaso + 1 gancio					BI - TE - VE - NE	€ 46,00
K_5180_3 Kit only: 3 pots + 3 hooks Solo kit: 3 vasi + 3 ganci					BI - TE - VE - NE	€ 117,00

Polypropylene and powder coated steel frame colours
Colori polipropilene e struttura in acciaio verniciato



TECHNICAL DETAILS / Dettagli tecnici

Item 5181

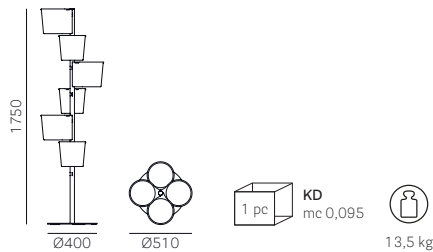

Item 5182



Item 5183

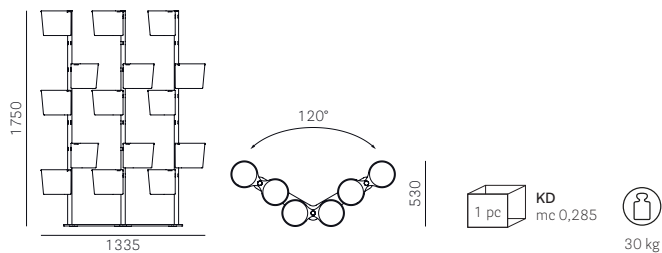

BRIK

Umbrella stand / Portaombrelli

VAT NOT INCLUDED / Iva esclusa

Complements / Complementi

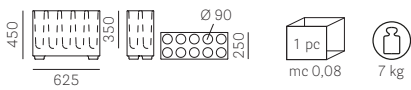
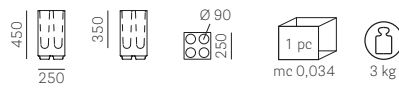

Item Articolo	Frame Telaio	Polyethylene Polietilene
BRIK	PET	€ 266,00
BRIK4	PET	€ 143,00

TECHNICAL DETAILS / Dettagli tecnici**Item BRIK****Item BRIK4****PET colours**

Colori PET





Item Articolo	Frame Telaio	Seat Sedile	Polyethylene Polietilene	Lighting kit Kit illuminazione	Steel Acciaio	Fabric Tessuto
KADO	PET H600		€ 345,00			
KADO2	PET H1000		€ 511,00			
KADO_LUCE Lighting kit only Solo kit illuminazione				€ 117,00 For Kado BI KADO + KADO_LUCE = € 462,00		
KADO_FIX Floor fixing kit only Solo kit per fissaggio a terra					€ 93,00	
KADO_TROLLEY Trolley only Solo carrello					€ 158,00	
KADO_3 For item KADO cushion only Solo cuscino per Art. KADO		C G H P				MDF idrofugo nobilitato € 192,00 € 268,00 € 195,00 € 338,00

TECHNICAL DETAILS / Dettagli tecnici

Item KADO

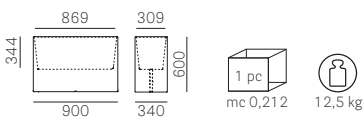

Item KADO2

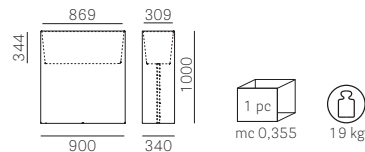

Item KADO_LUCE

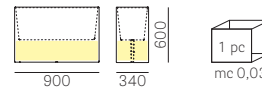

Item KADO_FIX

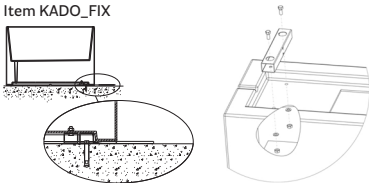

Item KADO_TROLLEY

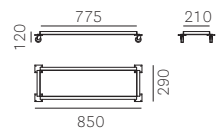

Item KADO.3

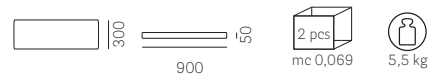

PET colours Colori PET



For fabrics see page 284
Per i tessuti si veda p. 284

Requests for special upholstery must be agreed at the order confirmation
Eventuali richieste di tappezzeria speciale vanno concordate alla conferma dell'ordine

SNOOZE

Sound absorbing / Pannello fonoassorbente



Item Articolo	Finish Finitura	Price Prezzo
SNZ01P	C83+C89; C100+C101	€ 281,00
	G21+G24	
	G59+G78; G190+G197	€ 363,00
	G110+G116	
	G140+G146	
	G170+G176; G210+G213	
	H120+H127	€ 288,00

TECHNICAL DETAILS / Dettagli tecnici

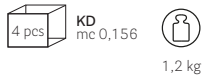
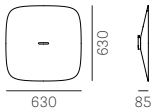

Metal element finish
Finitura elemento metallico



For fabrics see page 284
Per i tessuti si veda p. 284

EXAMPLES OF COMBINATIONS / ESEMPI DI CONFIGURAZIONI

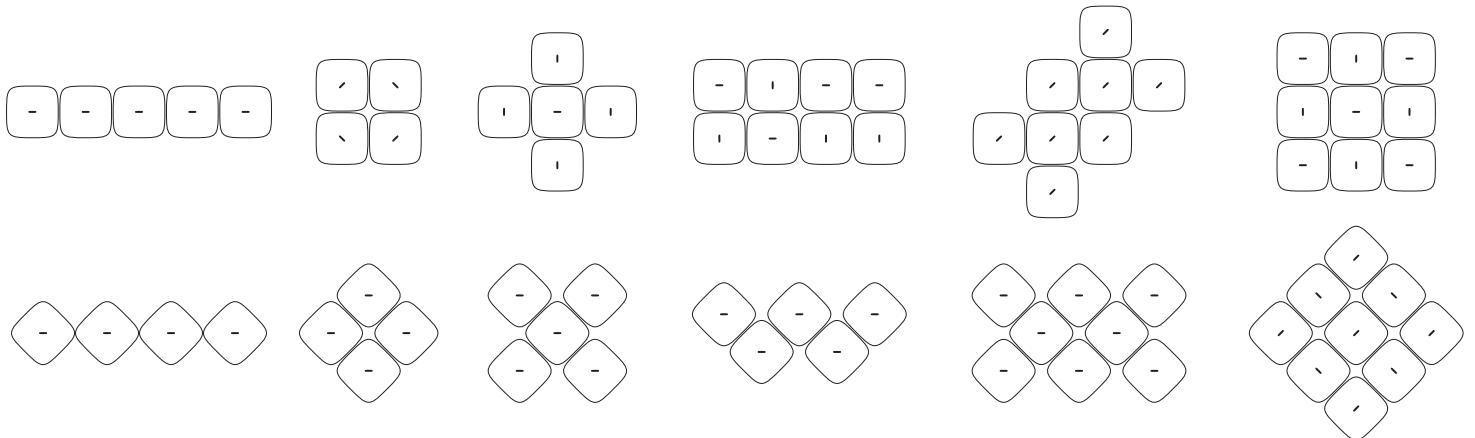

TOA Folding Screen

Sound absorbing / Pannello fonoassorbente



Item Articolo	Frame Telaio	Fabrics Tessuti	Price Prezzo
		C83+C89; C100+C101 C110+C122 C210+C217	€ 866,00
TFS	NEF	D	€ 1.008,00
		G Excluding / Escluso G150+G156, G180+G185, G220+G225, G230+G239	€ 1.228,00
		H120+H127	€ 921,00

TECHNICAL DETAILS / Dettagli tecnici

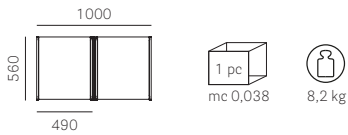

EXAMPLES OF COMBINATIONS / ESEMPI DI CONFIGURAZIONI

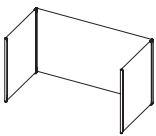

U

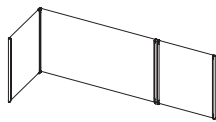

L

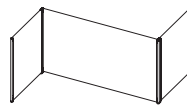

S

Frame finish Finitura telaio



NEF

For fabrics see page 284
Per i tessuti si veda p. 284

YPSILON CONNECT L110

Sound absorbing partition panel / Pannello divisorio fonoassorbente



ON FEET / SU PIEDINI

Item Articolo	Frame Telaio	High panel Pannello alto	Low panel Pannello basso	White/black powder coated Verniciato bianco/nero	Polished aluminium Alluminio lucidato
YCF_L110 Partition panel Pannello	1700x1100	C83+C89; C100+C101 C110+C122	C83+C89; C100+C101 C110+C122	€ 1.598,00	€ 1.676,00
		D	D	€ 1.771,00	€ 1.849,00
		G *	G *	€ 2.038,00	€ 2.117,00
		H120+H127	H120+H127	€ 1.661,00	€ 1.740,00
YCLF_L110 Partition panel with magnetic whiteboard Pannello con lavagna magnetica	1700x1100	C83+C89; C100+C101 C110+C122	C83+C89; C100+C101 C110+C122	€ 1.802,00	€ 1.880,00
		D	D	€ 1.913,00	€ 1.991,00
		G *	G *	€ 2.093,00	€ 2.171,00
		H120+H127	H120+H127	€ 1.841,00	€ 1.921,00

ON CASTORS / SU RUOTE

Item Articolo	Frame Telaio	High panel Pannello alto	Low panel Pannello basso	White/black powder coated Verniciato bianco/nero	Polished aluminium Alluminio lucidato
YC_L110 Partition panel Pannello	1790x1100	C83+C89; C100+C101 C110+C122	C83+C89; C100+C101 C110+C122	€ 1.637,00	€ 1.715,00
		D	D	€ 1.810,00	€ 1.888,00
		G *	G *	€ 2.078,00	€ 2.156,00
		H120+H127	H120+H127	€ 1.700,00	€ 1.779,00
YCL_L110 Partition panel with magnetic whiteboard Pannello con lavagna magnetica	1790x1100	C83+C89; C100+C101 C110+C122	C83+C89; C100+C101 C110+C122	€ 1.841,00	€ 1.921,00
		D	D	€ 1.952,00	€ 2.030,00
		G *	G *	€ 2.132,00	€ 2.212,00
		H120+H127	H120+H127	€ 1.880,00	€ 1.960,00

*Excluding / Escluso G21+G24, G110+G116, G180+G185, G220+G225, G230+G239

TECHNICAL DETAILS / Dettagli tecnici

Item YCF_L110

Item YCLF_L110

Item YC_L110

Item YCL_L110

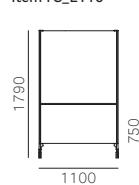
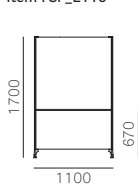
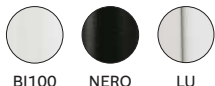
Frame finishes
Finiture telaio

BI100

NERO

LU

For fabrics see page 284
Per i tessuti si veda p. 284

YPSILON CONNECT L150

Sound absorbing partition panel / Pannello divisorio fonoassorbente



ON FEET / SU PIEDINI

Item Articolo	Frame Telaio	High panel Pannello alto	Low panel Pannello basso	White/black powder coated Verniciato bianco/nero	Polished aluminium Alluminio lucidato
YCF_L150 Partition panel Pannello	1700x1500	C83+C89; C100+C101 C110+C122	C83+C89; C100+C101 C110+C122	€ 1.872,00	€ 1.952,00
		D	D	€ 2.109,00	€ 2.187,00
		G *	G *	€ 2.470,00	€ 2.550,00
		H120+H127	H120+H127	€ 1.967,00	€ 2.045,00
YCLF_L150 Partition panel with magnetic whiteboard Pannello con lavagna magnetica	1700x1500	C83+C89; C100+C101 C110+C122	C83+C89; C100+C101 C110+C122	€ 2.062,00	€ 2.140,00
		D	D	€ 2.220,00	€ 2.298,00
		G *	G *	€ 2.463,00	€ 2.542,00
		H120+H127	H120+H127	€ 2.125,00	€ 2.203,00

ON CASTORS / SU RUOTE

Item Articolo	Frame Telaio	High panel Pannello alto	Low panel Pannello basso	White/black powder coated Verniciato bianco/nero	Polished aluminium Alluminio lucidato
YC_L150 Partition panel Pannello	1790x1500	C83+C89; C100+C101 C110+C122	C83+C89; C100+C101 C110+C122	€ 1.913,00	€ 1.991,00
		D	D	€ 2.148,00	€ 2.227,00
		G *	G *	€ 2.509,00	€ 2.589,00
		H120+H127	H120+H127	€ 2.006,00	€ 2.086,00
YCL_L150 Partition panel with magnetic whiteboard Pannello con lavagna magnetica	1790x1500	C83+C89; C100+C101 C110+C122	C83+C89; C100+C101 C110+C122	€ 2.101,00	€ 2.179,00
		D	D	€ 2.259,00	€ 2.337,00
		G *	G *	€ 2.502,00	€ 2.581,00
		H120+H127	H120+H127	€ 2.164,00	€ 2.243,00

*Excluding / Escluso G21+G24, G110+G116, G180+G185, G220+G225, G230+G239

TECHNICAL DETAILS / Dettagli tecnici

Item YCF_L150

Item YCLF_L150

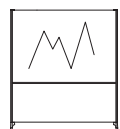
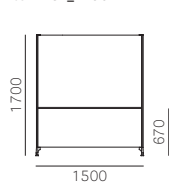

Item YC_L150

Item YCL_L150

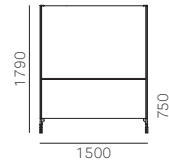

Frame finishes Finiture telaio

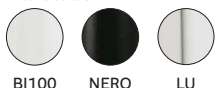
For fabrics see page 284
Per i tessuti si veda p. 284

YPSILON CONNECT optional / accessori

L110 / L150



L110

Item Articolo	Finish Finitura	Solid laminate Stratificato	White/black powder coated Verniciato bianco/nero
YC02_L110 Upper two-tier shelves Coppia di mensole alte	CFP_BI FNP_NE	€ 268,00 (1 pc / 1 pz)	
YC01_L110 Middle height shelf Mensola intermedia	CFP_BI FNP_NE	€ 150,00 (1 pc / 1 pz)	
YC06 Set hooks Set ganci			€ 77,00 (1 pc / 1 pz)

L150

Item Articolo	Finish Finitura	Solid laminate Stratificato	White/black powder coated Verniciato bianco/nero
YC02_L150 Upper two-tier shelves Coppia di mensole alte	CFP_BI FNP_NE	€ 348,00 (1 pc / 1 pz)	
YC01_L150 Middle height shelf Mensola intermedia	CFP_BI FNP_NE	€ 182,00 (1 pc / 1 pz)	
YC06 Hooks set Set ganci			€ 77,00 (1 pc / 1 pz)

Optional accessories are supplied same colour as the frame, for polished aluminium finish accessories are always supplied in black colour
Gli accessori sono forniti in abbinamento al telaio, in caso di telaio alluminio lucidato sono forniti neri

TECHNICAL DETAILS / Dettagli tecnici

Item YC02_L110



Item YC01_L110



Item YC06

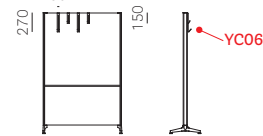

Item YC02_L150



Item YC01_L150

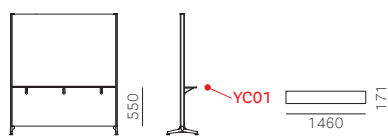

Item YC06

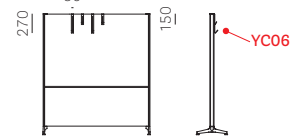

Solid laminate shelves finishes Finiture mensole in stratificato



Hooks finishes Finiture ganci



EXAMPLES OF COMBINATIONS / ESEMPI DI CONFIGURAZIONI

YCF_L110



YC_L110



YCF_L150

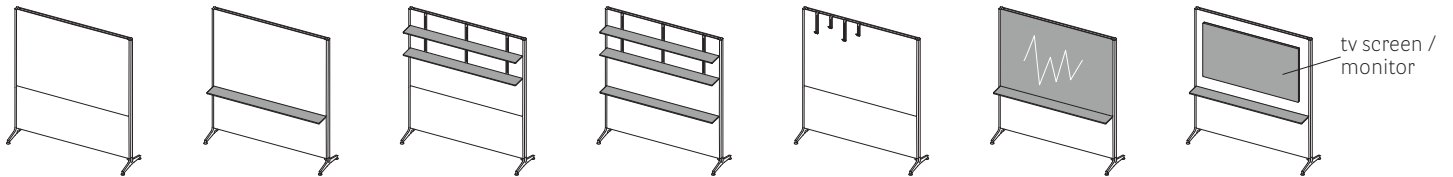

YC_L150

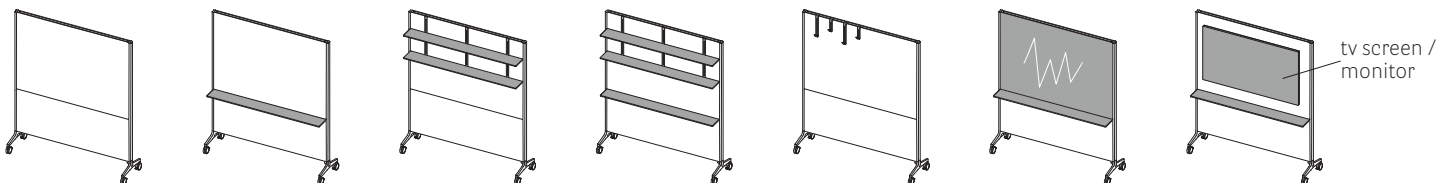

INOX

Crowd control columns / Tranne segnapercorso

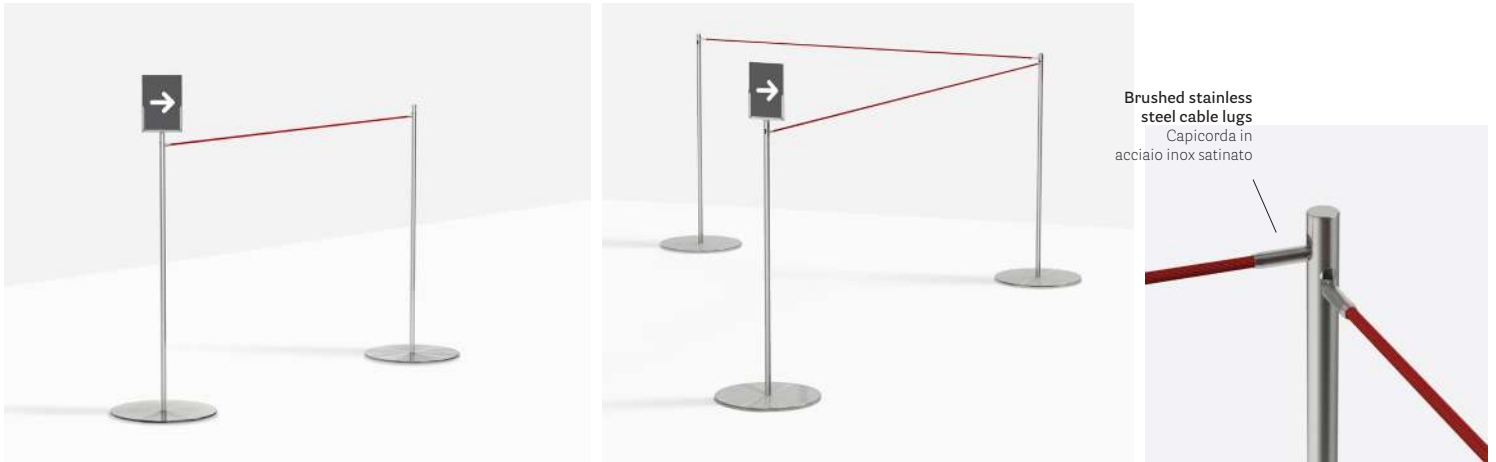

Frame
Telaio

Item Articolo	Base Base	Height Altezza	Column Colonna	Length Lunghezza	Finish Finitura	Price Prezzo
5171 Base column Colonnina base	Ø 400	1050	Ø 20		POWDER COATED Verniciato	€ 167,00
					BRUSHED S/STEEL Inox satinato	€ 245,00
K_5170_LINK/RO_3 Rope kit Kit corda				3 mt	BRUSHED S/STEEL Inox satinato	€ 95,00
K_5170.10 Signage support kit Kit supporto cartello					BRUSHED S/STEEL Inox satinato	€ 95,00 signage is possible in format A4 vertical or A5 horizontal sarà possibile inserire A4 verticale o A5 orizzontale

TECHNICAL DETAILS / Dettagli tecnici

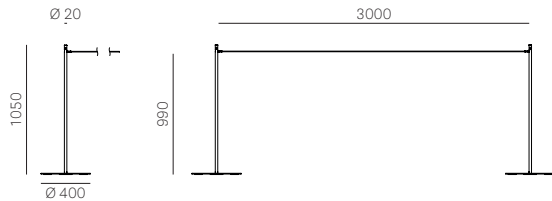

Rope colour
Colore corda



1 pc
mc 0,031

7
kg

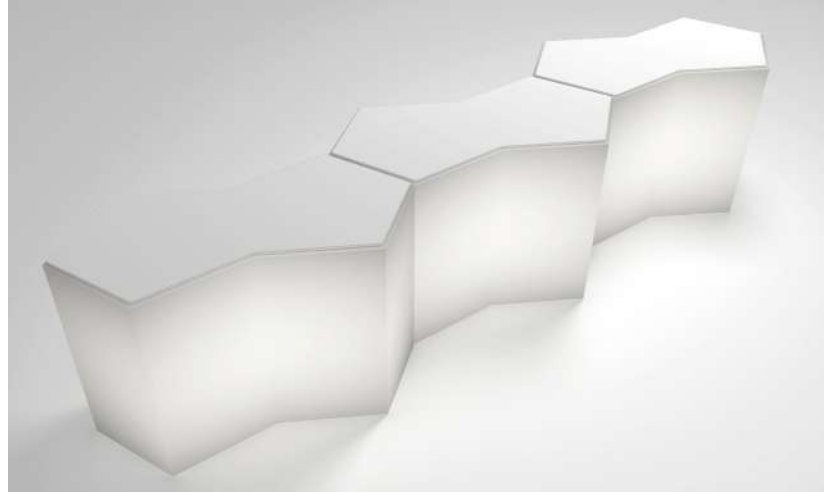
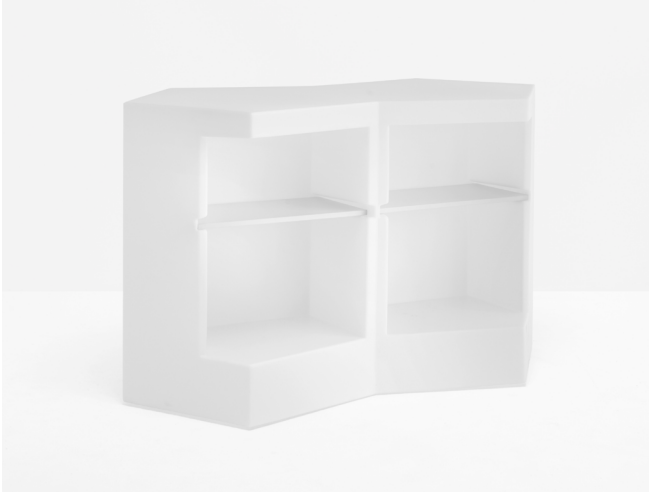

Item Articolo	Frame Telaio	Polyethylene Polietilene	Lighting kit Kit illuminazione	Methacrylate Metacrilato	White powder coated Verniciato bianco
IBE_BI	PET	€ 1.274,00			
IBE_LUCE Lighting kit only Solo kit illuminazione		IBE_BI + IBE_LUCE = € 1.511,00 English plug version: upcharge € 51,00 (item IBE_LUCE_UK) Versione con presa britannica: supplemento € 51,00 (Art. IBE_LUCE_UK)	€ 237,00		
IBE_SUP_MET_BI Upper top only Solo ripiano superiore		IBE_BI + IBE_SUP_MET_BI = € 1.778,00		€ 504,00	
IBE_INF__BI Lower top only Solo ripiano inferiore		IBE_BI + IBE_INF__BI = € 1.364,00			€ 90,00

TECHNICAL DETAILS / Dettagli tecnici

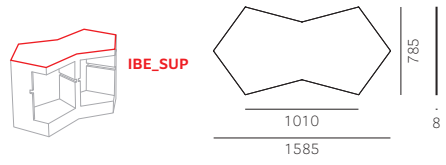
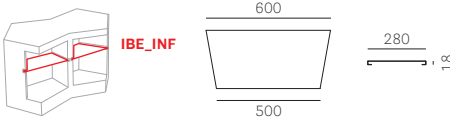
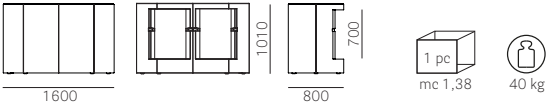

PET colours
Colori PET



BI



Item Articolo	Frame Telaio	Polyethylene Polietilene	Lighting kit Kit illuminazione	Methacrylate Metacrilato	White powder coated Verniciato bianco
IGL_BI/RIP_BI	PET + Top LBI sp 15 mm White steel top Lamiera bianca	€ 1.299,00			
IGL_LUCE Lighting kit only Solo kit illuminazione		IGL_BI/RIP_BI + IGL_LUCE = € 1.466,00	€ 167,00		
IGL_SUP_MET_BI Upper top only Solo ripiano superiore		IGL_BI/RIP_BI + IGL_SUP_MET_BI = € 1.528,00		€ 229,00	
K_RIP_INF_BI100E Lower tops only Solo ripiani inferiori		IGL_BI/RIP_BI + K_RIP_INF_BI100E = € 1.606,00			€ 307,00 (Set composed by 3 tops Set composto da 3 ripiani)

TECHNICAL DETAILS / Dettagli tecnici

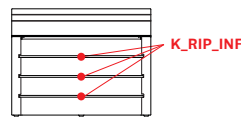
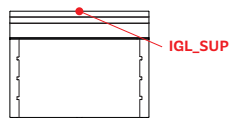
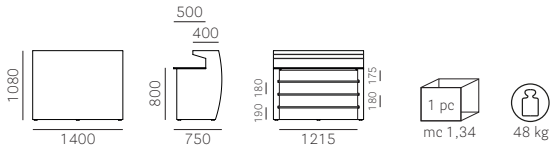

PET colours
Colori PET



BI

IGLOO corner



Bar counter / Banco bar

VAT NOT INCLUDED / Iva esclusa

Complements / Complementi



Item Articolo	Frame Telaio	Polyethylene Polietilene	Lighting kit Kit illuminazione
IGLC_CORNER	PET + Top LBI White steel top Lamiera bianca	€ 1.009,00 Module to be used only in combination with item IGL_BI/RIP_BI and IGL_WORKSTATION Modulo da utilizzare esclusivamente in abbinamento all'articolo IGL_BI/RIP_BI e IGL_WORKSTATION	
IGLC_LUCE Lighting kit only Solo kit illuminazione		IGLC_CORNER + IGLC_LUCE = € 1.176,00	€ 167,00

TECHNICAL DETAILS / Dettagli tecnici

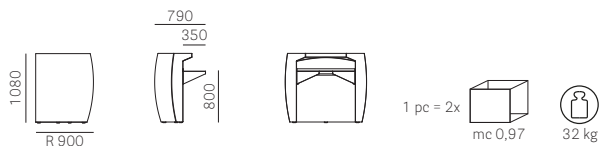

SOME POSSIBLE COMBINATIONS / ALCUNE POSSIBILI CONFIGURAZIONI

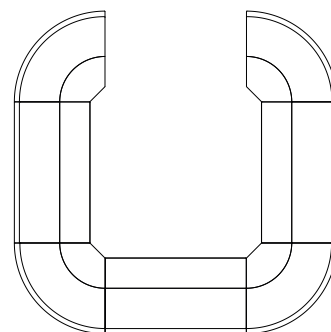
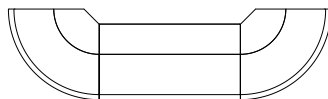
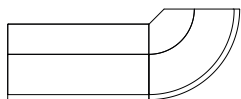

PET colours
Colori PET



BI

IGLOO console



Bar counter / Banco bar

VAT NOT INCLUDED / Iva esclusa

Complements / Complementi



Item Articolo	Frame Telaio	Polyethylene Polietilene	Lighting kit Kit illuminazione
IGLC_CONSOLLE	PET + Top LBI sp 15 mm White steel top Lamiera bianca	€ 1.883,00	
IGLC_LUCE Lighting kit only Solo kit illuminazione	2x IGLC_LUCE	IGLC_CONSOLLE + 2 x IGLC_LUCE = € 2.217,00	€ 334,00

TECHNICAL DETAILS / Dettagli tecnici

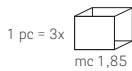
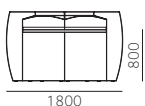
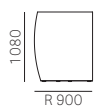

PET colours
Colori PET



BI

IGLOO workstation

Bar counter / Banco bar



VAT NOT INCLUDED / Iva esclusa

Complements / Complementi



Item Articolo	Frame Telaio	Polyethylene Polietilene	Lighting kit Kit illuminazione	Methacrylate Metacrilato
IGL_WORKSTATION	PET + n° 1 stainless steel work top / piano di lavoro in acciaio inox n° 1 stainless steel tray with holes for ice / contenitore portaghiaccio formato in acciaio inox n° 5 five trays for fresh fruit / contenitori porta frutta in acciaio inox n° 1 polyethylene cutting board / tagliere in polietilene n° 1 white powder coated bottle carrier / portabottiglie verniciato bianco n° 1 stainless steel liquid recovery tank (kit for drainage included) / vasca di recupero liquidi in acciaio inox (kit raccordi per scarico inclusi)	€ 2.698,00		
IGL_LUCE Lighting kit only Solo kit illuminazione		IGL_WORKSTATION + IGL_LUCE = € 2.865,00	€ 167,00	
IGL_SUP_MET_BI Upper top only Solo ripiano superiore		IGL_WORKSTATION + IGL_SUP_MET_BI = € 2.927,00		€ 229,00
K_RIP_INF_BI100E Lower tops only Solo ripiani inferiori		IGL_WORKSTATION + K_RIP_INF_BI100E = € 3.005,00		€ 307,00 (Set composed by 3 tops Set composto da 3 ripiani)

TECHNICAL DETAILS / Dettagli tecnici

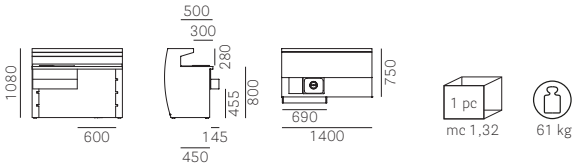

PET colours





Item Articolo	Frame Telaio	Polyethylene Polietilene	Lighting kit Kit illuminazione	Methacrylate Metacrilato	White powder coated Verniciato bianco
OBL_BI	PET	€ 1.281,00			
IGL_LUCE Lighting kit only Solo kit illuminazione		OBL_BI + IGL_LUCE = € 1.448,00	€ 167,00		
OBL_SUP_MET_BI Upper top only Solo ripiano superiore		OBL_BI + IGL_LUCE + OBL_SUP_MET_BI = € 1.677,00		€ 229,00	
OBL_RIP_MET_BI Upper top only Solo ripiano superiore		OBL_BI + IGL_LUCE + OBL_RIP_MET_BI = € 1.731,00 OBL_BI + IGL_LUCE + OBL_SUP_MET_BI + OBL_RIP_MET_BI = € 1.960,00		€ 283,00	
K_RIP_INF_BI100E Lower tops only Solo ripiani inferiori		OBL_BI + IGL_LUCE + K_RIP_INF_BI100E = € 1.755,00 OBL_BI + IGL_LUCE + OBL_RIP_MET_BI + OBL_SUP_MET_BI + K_RIP_INF_BI100E = € 2.267,00			€ 307,00 (Set composed by 3 tops Set composto da 3 ripiani)

TECHNICAL DETAILS / Dettagli tecnici

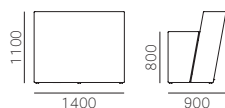

Adjustable feet included
Piedini regolabili inclusi

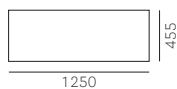
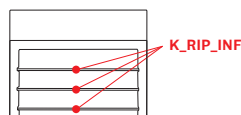
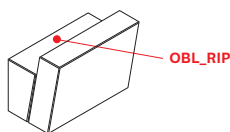
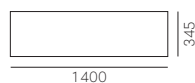
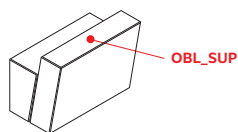

PET colours Colori PET



BI

OBLIQUE soft

Bar counter / Banco bar



Item Articolo	Frame Telaio	Smooth Liscio	Stitches Cuciture	White powder coated Verniciato bianco	Black powder coated Verniciato nero
OBL/A	BI + TOP (sp 8 mm) upper and work top in white methacrylate ripiano superiore e di lavoro in metacrilato bianco				
	C	€ 2.610,00	€ 2.610,00		
	D	€ 2.685,00	€ 2.685,00		
	G*	€ 2.801,00	€ 2.801,00		
	H	€ 2.634,00	€ 2.634,00		
K_RIP_INF_BI100E Lower tops only Solo ripiani inferiori				€ 307,00 (Set composed by 3 tops Set composto da 3 ripiani)	
OBL/A	GA + TOP (sp 8 mm) upper and work top in black methacrylate ripiano superiore e di lavoro in metacrilato nero				
	C	€ 2.730,00	€ 2.730,00		
	D	€ 2.807,00	€ 2.807,00		
	G*	€ 2.923,00	€ 2.923,00		
	H	€ 2.758,00	€ 2.758,00		
K_RIP_INF_NPE Lower tops only Solo ripiani inferiori				€ 307,00 (Set composed by 3 tops Set composto da 3 ripiani)	

*Excluding / Escluso G220+G225

TECHNICAL DETAILS / Dettagli tecnici

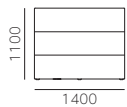
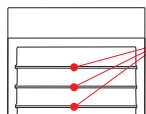
Adjustable feet included
Piedini regolabili inclusi

K_RIP_INF

PET colours
Colori PETFor fabrics see page 284
Per i tessuti si veda p. 284

OBLIQUE corner



Bar counter / Banco bar

VAT NOT INCLUDED / Iva esclusa

Complements / Complementi



Item Articolo	Frame Telaio	Polyethylene Polietilene	Lighting kit Kit illuminazione	Methacrylate Metacrilato
OBA_BI	PET	€ 1.021,00		
TTS_LUCE Lighting kit only Solo kit illuminazione		OBA_BI + TTS_LUCE = € 1.205,00	€ 184,00	
OBA_SUP_MET_BI Upper top only Solo ripiano superiore		OBA_BI + TTS_LUCE + OBA_SUP_MET_BI = € 1.532,00		€ 327,00
OBA_RIP_MET_BI Upper top only Solo ripiano superiore		OBA_BI + TTS_LUCE + OBA_RIP_MET_BI = € 1.421,00 OBA_BI + TTS_LUCE + OBA_SUP_MET_BI + OBA_RIP_MET_BI = € 1.748,00		€ 216,00

TECHNICAL DETAILS / Dettagli tecnici

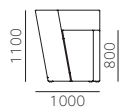

1 pc



32 kg

Adjustable feet included
Piedini regolabili inclusi

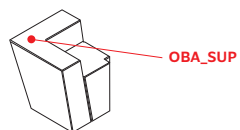

OBA_SUP

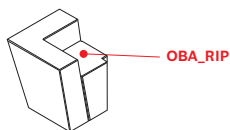
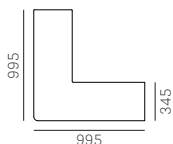

OBA_RIP

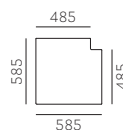

PET colours Colori PET



BI

OBLIQUE corner soft

Bar counter / Banco bar



Item Articolo	Frame Telaio	Smooth Liscio	Stitches Cuciture
OBA/A	BI + TOP (sp 8 mm) upper and work top in white methacrylate ripiano superiore e di lavoro in metacrilato bianco		
	C	€ 2.971,00	€ 2.971,00
	D	€ 3.104,00	€ 3.104,00
	G *	€ 3.309,00	€ 3.309,00
OBA/A	GA + TOP (sp 8 mm) upper and work top in black methacrylate ripiano superiore e di lavoro in metacrilato nero		
	C	€ 3.114,00	€ 3.114,00
	D	€ 3.247,00	€ 3.247,00
	G *	€ 3.452,00	€ 3.452,00
	H	€ 3.156,00	€ 3.156,00

*Excluding / Escluso G220+G225

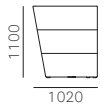
TECHNICAL DETAILS / Dettagli tecniciAdjustable feet included
Piedini regolabili inclusi**PET colours**
Colori PETFor fabrics see page 284
Per i tessuti si veda p. 284



Item Articolo	Frame Telaio	Polyethylene Polietilene	Lighting kit Kit illuminazione	Brushed s/steel Inox satinato	White powder coated Verniciato bianco
TTS_BI	PET	€ 1.274,00			
When single modules are joint the use of the upper tops is suggested. See page 245 In caso di accostamento dei singoli moduli è consigliato l'utilizzo dei ripiani superiori. Vedere a pagina 245					
TTS_LUCE Lighting kit only Solo kit illuminazione			€ 184,00		
English plug version: upcharge € 51,00 (item TTS_LUCE_UK) Versione con presa britannica: supplemento € 51,00 (Art.TTS_LUCE_UK)					
TTS_SUP_130/140/150 Upper top only Solo ripiano superiore				€ 389,00	€ 389,00
TTS_SUP_185 Upper top only Solo ripiano superiore				€ 406,00	€ 406,00
TTS_RIP Lower top only Solo ripiano inferiore				€ 357,00	
TTS_INF Lower top only Solo ripiano inferiore				€ 224,00	

TECHNICAL DETAILS / Dettagli tecnici

Item TTS_BI

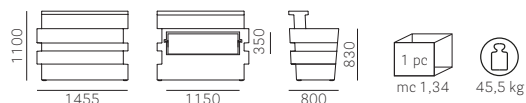

Item TTS_LUCE

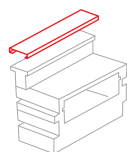
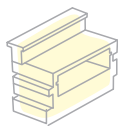

TTS_SUP

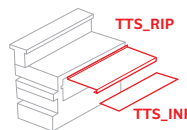
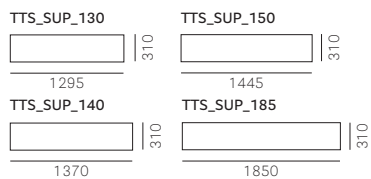

TTS_RIP

TTS_INF

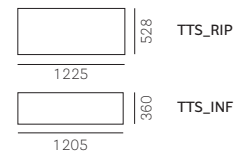

PET colours Colori PET



BI



Item Articolo	Frame Telaio	Polyethylene Polietilene	Lighting kit Kit illuminazione
T TSA_BI	PET	€ 1.178,00	
T TS_LUCE Lighting kit only Solo kit illuminazione		English plug version: upcharge € 51,00 (item TTS_LUCE_UK) Versione con presa britannica: supplemento € 51,00 (Art.TTS_LUCE_UK)	€ 184,00

TECHNICAL DETAILS / Dettagli tecnici

Item TTS_BI

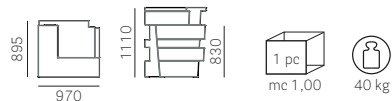

Item TTS_LUCE

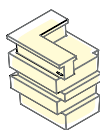

PET colours Colori PET



BI

EXAMPLES OF COMBINATIONS upper top (TTS_SUP) / ESEMPI DI CONFIGURAZIONI ripiano superiore (TTS_SUP)

TTS (1 pc/pz)



TTS (2 pcs/pz)

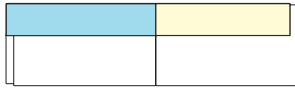

TTS (3 pcs/pz)



TTS (4 pcs/pz)

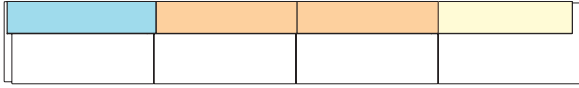

TTS (1 pc/pz), TTSA (1 pc/pz)

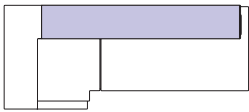

TTS (2 pcs/pz), TTSA (1 pc/pz)

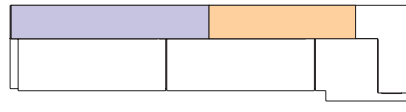

TTS (2 pcs/pz), TTSA (1 pc/pz)

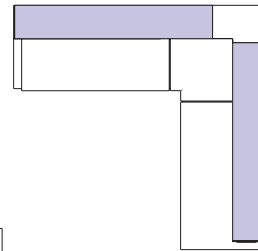

TTS (3 pcs/pz), TTSA (2 pcs/pz)

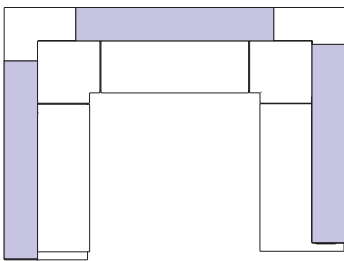

TTS (3 pcs/pz), TTSA (2 pcs/pz)

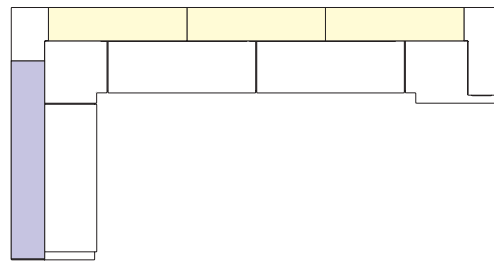

TTS (3 pcs/pz), TTSA (1 pc/pz)

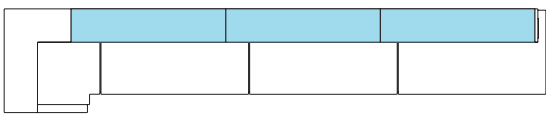

TTS (3 pcs/pz), TTSA (2 pcs/pz)

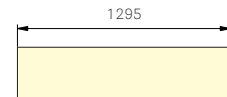
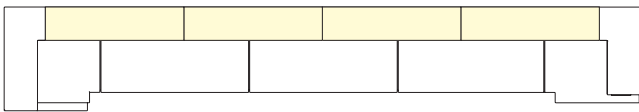

TTS_SUP_130

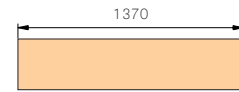

TTS_SUP_140

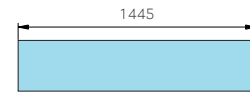

TTS_SUP_150



TTS_SUP_185

In case of orders for more than 2 pieces for Tetris bar counter (TTS_BI) with upper top (TTS_SUP), we kindly ask you to confirm us if they are combined together, in order to supply you the correct tops' length.

Per ordini superiori ai 2 pezzi di bancone Tetris (TTS_BI) con ripiano superiore (TTS_SUP) preghiamo di specificare eventuale accostamento in modo da fornire il ripiano nella misura corretta.



COLETTE

COLETTE 50

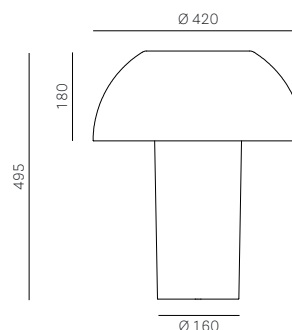
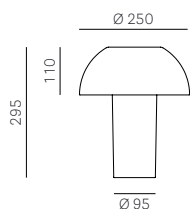

L003TA/BI

MAX 1x15W E14 220-240V

CE IP 20

6 pcs **€ 75,00**

1 pc **€ 81,00**

L003TA

MAX 1x15W E14 220-240V

CE IP 20

6 pcs **€ 86,00**

1 pc **€ 94,00**

L003TB/BI

MAX 1x32W E27 220-240V

CE IP 20

€ 158,00

1 pc

L003TB

MAX 1x32W E27 220-240V

CE IP 20

€ 201,00

1 pc

English plug version: upcharge **€ 43,00**
Versione con presa britannica: supplemento **€ 43,00**

English plug version: upcharge **€ 43,00**
Versione con presa britannica: supplemento **€ 43,00**



BI
White
Bianco



RT
Transparent red
Rosso trasparente



FU
Smoky grey
Fumé



TR
Clear transparent
Trasparente



BT
Transparent blue
Blu trasparente



GT
Transparent yellow
Giallo trasparente



BI
White
Bianco



TR
Clear transparent
Trasparente

The device is provided with bulb of energy class: A+ / Il dispositivo è venduto con una lampadina di classe energetica: A+

Price includes light bulb / La lampadina è compresa nel prezzo

L003TA: LED 5,7W 2700°K

L003TB: LED 14W 2700°K



1799T
LED ARRAY 2W 3,7V 500mA 3000°K
CE IP 65
€ 234,00

330
Ø 150

1 pc MC 0,006

1799T/50
LED ARRAY 2W 3,7V 500mA 3000°K
CE IP 65
€ 241,00

500
Ø 150

1 pc MC 0,008

1799T/130
LED ARRAY 2W 3,7V 500mA 3000°K
CE IP 65
€ 344,00

1300
Ø 150

1 pc MC 0,017

1799_MGN_10
Magnet kit (10 pcs) **€ 143,00**
Kit magnete (10 pz) **€ 143,00**
Suitable for items 1799T and 1799T/50
Valido per art. 1799T e 1799T/50



PACKAGING / Imballo



The packaging includes one micro USB cable and one battery charger with Europlug type C.

L'imballo include un cavo di ricarica micro USB e un carica-batterie con spina europea tipo C.

COLOURS / Colori



BATTERY / Batteria

Lithium battery (Li-Po): over 8 hours operating time.
Batteria al litio (Li-Po): durata per oltre 8 ore.



FLOOR/HANGING LAMP / Lampada da terra/a sospensione

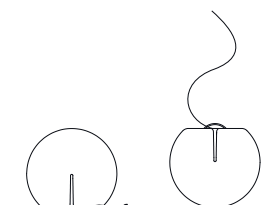

Ø 500

330E

MAX 1x32W E27 220-240V

CE IP 65

€ 214,00



HAPPY_APPLE_FIX

Floor fixing kit: upcharge € 75,00

Kit per il fissaggio a terra: supplemento € 75,00

Preparation for hanging, to be done by the customer
Predisposizione per l'appensione a cura del cliente

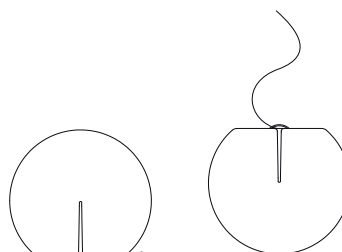

Ø 800

331E

MAX 1x32W E27 220-240V

CE IP 65

€ 363,00



HAPPY_APPLE_FIX

Floor fixing kit: upcharge € 75,00

Kit per il fissaggio a terra: supplemento € 75,00

Preparation for hanging, to be done by the customer
Predisposizione per l'appensione a cura del cliente

FLOOR LAMP / Lampada da terra

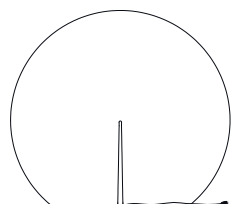

Ø 1200

332E

MAX 1x32W E27 220-240V

CE IP 65

€ 540,00



HAPPY_APPLE_FIX

Floor fixing kit: upcharge € 75,00

Kit per il fissaggio a terra: supplemento € 75,00

CAP AND HANDLE COLOUR / Colore tappo e maniglia



VE
Green
Verde

CABLE COLOUR / Colore cavo



VE
Green
Verde

The device is provided with bulb of energy class: A+ / Il dispositivo è venduto con una lampadina di classe energetica: A+

Price includes light bulb / La lampadina è compresa nel prezzo

330E: LED 10W 6500°K

331E: LED 13W 6500°K

332E: FBT 1x32W 6500°K

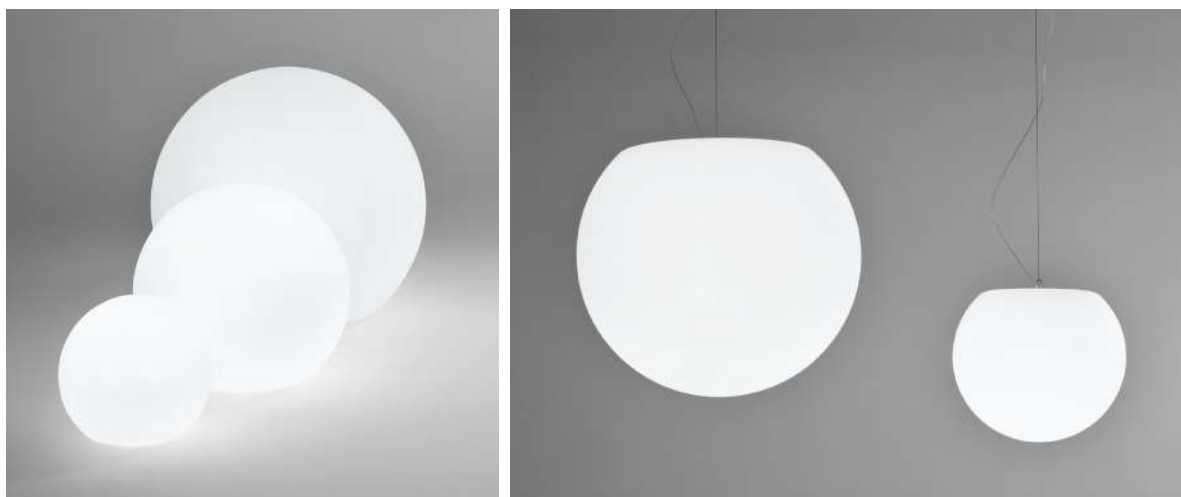

HANGING LAMP / Lampada a sospensione

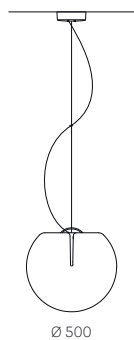

330S
MAX 1x32W E27 220-240V
CE IP 20
€ 258,00

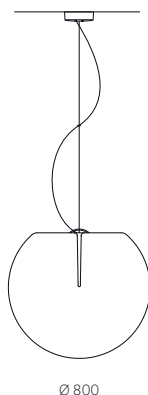

331S
MAX 1x32W E27 220-240V
CE IP 20
€ 406,00



WALL/CEILING LAMP / Lampada a muro/soffitto

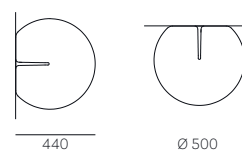

330A
MAX 1x32W E27 220-240V
CE IP 20
€ 258,00



FLOOR LAMP / Lampada da terra

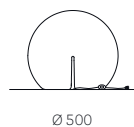

330
MAX 1x32W E27 220-240V
CE IP 20
€ 214,00

330_UK
English plug version
Versione con presa britannica

€ 258,00

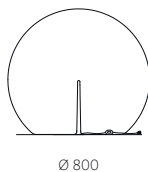

331
MAX 1x32W E27 220-240V
CE IP 20
€ 363,00

331_UK
English plug version
Versione con presa britannica

€ 406,00

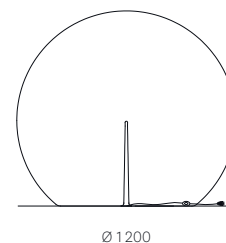

332
MAX 1x32W E27 220-240V
CE IP 20
€ 540,00

332_UK
English plug version
Versione con presa britannica

€ 584,00



CEILING ROSE COLOUR / Colore rosone



CABLE COLOUR / Colore cavo

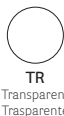

CAP AND HANDLE COLOUR / Colore tappo e maniglia



The device is provided with bulb of energy class: A+ / Il dispositivo è venduto con una lampadina di classe energetica: A+

Price includes light bulb / La lampadina è compresa nel prezzo

330, 330S, 330A: LED 10W 6500°K

331, 331S: LED 13W 6500°K

332: FBT 1x32W 6500°K

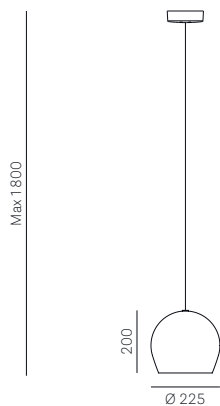

L007S/A

MAX 1x23W E27 220-240V

CE IP 20

€ 260,00

€ 364,00 (OS, RM2)



Cable length 1,5 m
Lunghezza cavo 1,5 m

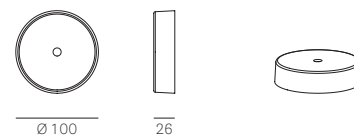

DIFFUSER COLOURS / Colori diffusore

Powder coating

Verniciato



NEF Black
Nero soft-touch

GA Anthracite grey
Grigio antracite

BE200 Beige

BI200 White
Bianco



OS Brass
Ottone

RM2 Copper
Rame



RA200 Pink
Rosa

TE Terracotta

GI200 Yellow
Giallo

VE100 Green
Verde

CEILING ROSE AND CABLE COLOUR / Colore rosone e cavo



Matt black Nero opaco

Matt white Bianco opaco

Minimum order quantity: 4 hanging lamps / Ordine minimo: 4 lampade a sospensione

The device provided with bulb of energy class: A+ / Il dispositivo è venduto con una lampadina di classe energetica A+

Price includes light bulb / La lampadina è compresa nel prezzo
L007S/A: LED 13W 3000°K

L001S



*Inner diffuser = colour BI only
Diffusore interno = solo colore BI

DIFFUSER COLOURS / Colori diffusore

Transparent

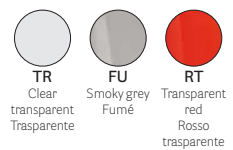

Full colour



Minimum order quantity: 4 hanging lamps / Ordine minimo: 4 lampade a sospensione

The device is compatible with bulbs of the following energy classes: from E to A++ / Questo dispositivo è compatibile con lampadine di classi energetiche: da E a A++

Price doesn't include light bulb / La lampadina non è compresa nel prezzo

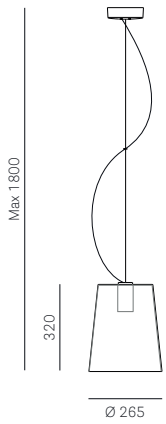

L001S/A

MAX 1x75W E27 220-240V

CE IP 20

€ 94,00



Cable length > 4m: upcharge € 29,00
Lunghezza cavo > 4m: supplemento € 29,00

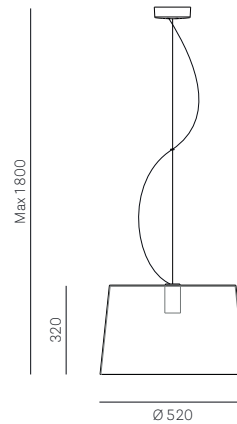

L001S/B

MAX 1x75W E27 220-240V

CE IP 20

€ 143,00



Cable length > 4m: upcharge € 29,00
Lunghezza cavo > 4m: supplemento € 29,00

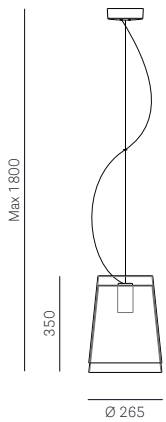

L001S/AA

MAX 1x75W E27 220-240V

CE IP 20

€ 143,00



Cable length > 4m: upcharge € 29,00
Lunghezza cavo > 4m: supplemento € 29,00

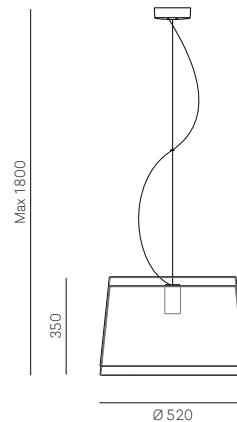

L001S/BB

MAX 1x75W E27 220-240V

CE IP 20

€ 244,00



Cable length > 4m: upcharge € 29,00
Lunghezza cavo > 4m: supplemento € 29,00

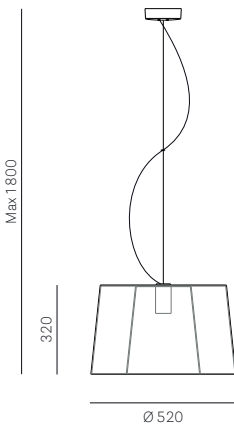

L001S/BA

MAX 1x75W E27 220-240V

CE IP 20

€ 194,00



Cable length > 4m: upcharge € 29,00
Lunghezza cavo > 4m: supplemento € 29,00

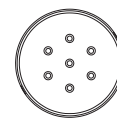

Ø 131



42

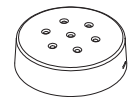

CEILING ROSE COLOUR / Colore rosone



RB
White
Bianco

Black colour fitting version (item RN): upcharge € 8,00
Versione con rosone colore nero (art. RN): supplemento € 8,00

Minimum order quantity: 4 hanging lamps / Ordine minimo: 4 lampade a sospensione

The device is compatible with bulbs of the following energy classes: from E to A++ / Questo dispositivo è compatibile con lampadine di classi energetiche: da E a A++

Price doesn't include light bulb / La lampadina non è compresa nel prezzo

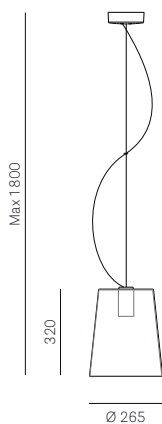

L001S/A

MAX 1x75W E27 220-240V

CE IP 20

€ 143,00



Cable length > 4m: upcharge € 29,00
Lunghezza cavo > 4m: supplemento € 29,00

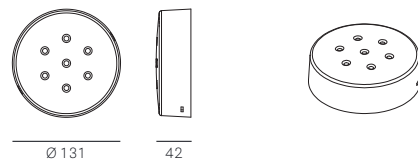

CEILING ROSE COLOUR / Colore rosone

DIFFUSER COLOURS / Colori diffusore

Soft-touch powder coating
Verniciato finitura soft-touch

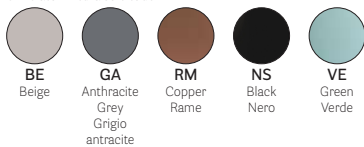

Black colour fitting version (item RN): upcharge € 8,00
Versione con rosone colore nero (art. RN): supplemento € 8,00

Minimum order quantity: 4 hanging lamps / Ordine minimo: 4 lampade a sospensione

The device is compatible with bulbs of the following energy classes: from E to A++ / Questo dispositivo è compatibile con lampadine di classi energetiche: da E a A++

Price doesn't include light bulb / La lampadina non è compresa nel prezzo

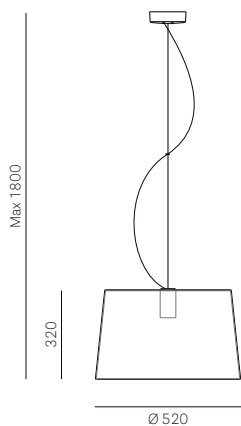
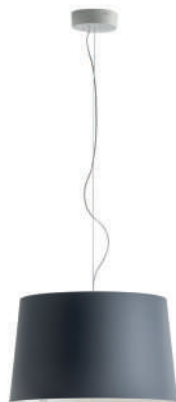

L001S/B

MAX 1x75W E27 220-240V

CE IP 20

€ 215,00



Cable length > 4m: upcharge **€ 29,00**
Lunghezza cavo > 4m: supplemento **€ 29,00**

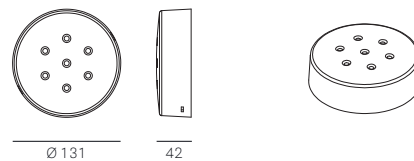

CEILING ROSE COLOUR / Colore rosone

DIFFUSER COLOURS / Colori diffusore

Soft-touch powder coating
Verniciato finitura soft-touch

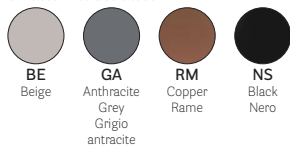

Black colour fitting version (item RN): upcharge **€ 8,00**
Versione con rosone colore nero (art. RN): supplemento **€ 8,00**

Minimum order quantity: 4 hanging lamps / Ordine minimo: 4 lampade a sospensione

The device is compatible with bulbs of the following energy classes: from E to A++ / Questo dispositivo è compatibile con lampadine di classi energetiche: da E a A++

Price doesn't include light bulb / La lampadina non è compresa nel prezzo

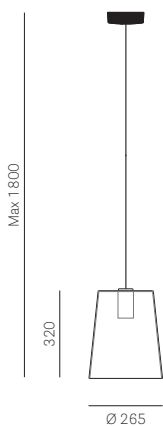

L001SW/A

MAX 1x23W E27 220-240V

CE IP 20

€ 108,00

(TR, VL, FU, RT)

€ 158,00

(BE, GA, RM, NS, VE)



MC 0,05

Cable length 1,5 m
Lunghezza cavo 1,5 m

DIFFUSER COLOURS / Colori diffusore

Transparent

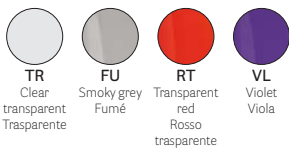

TR
Clear
transparent
Trasparente

FU
Smoky grey
Fumé

RT
Transparent
red
Rosso
trasparente

VL
Violet
Viola

Soft-touch powder coating

Verniciato finitura soft-touch

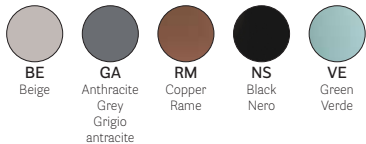

BE
Beige

GA
Anthracite
Grey
Grigio
antracite

RM
Copper
Rame

NS
Black
Nero

VE
Green
Verde

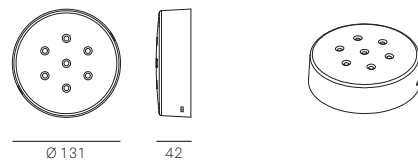

CEILING ROSE AND CABLE COLOUR / Colore rosone e cavo

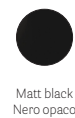

Matt black
Nero opaco

Minimum order quantity: 4 hanging lamps / Ordine minimo: 4 lampade a sospensione

The device is compatible with bulbs of the following energy classes: from B to A++ / Questo dispositivo è compatibile con lampadine di classi energetiche: da B a A++

Price doesn't include light bulb / La lampadina non è compresa nel prezzo

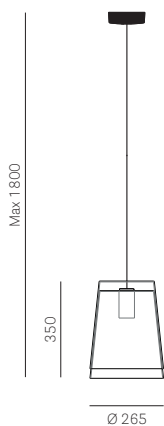

L001SW/AA

MAX 1x23W E27 220-240V

CE IP 20

€ 158,00 (TR, FU, RT)



Cable length 1,5 m
Lunghezza cavo 1,5 m

DIFFUSER COLOURS / Colori diffusore

Transparent

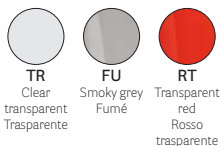

Full colour



*For inner diffuser A
Solo per diffusore interno A

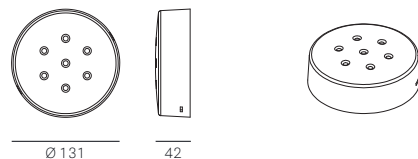

CEILING ROSE AND CABLE COLOUR / Colore rosone e cavo



Matt black
Nero opaco

Minimum order quantity: 4 hanging lamps / Ordine minimo: 4 lampade a sospensione

The device is compatible with bulbs of the following energy classes: from B to A++ / Questo dispositivo è compatibile con lampadine di classi energetiche: da B a A++

Price doesn't include light bulb / La lampadina non è compresa nel prezzo

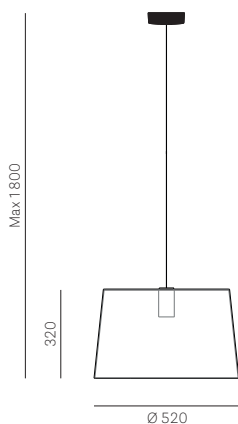
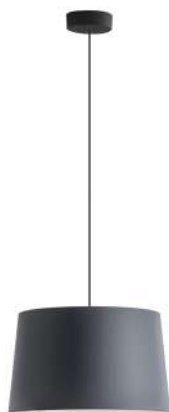

L001SW/B

MAX 1x23W E27 220-240V

CE IP 20

€ 158,00 (TR, FU, RT)

€ 229,00 (BE, GA, RM, NS)



Cable length 1,5 m
Lunghezza cavo 1,5 m

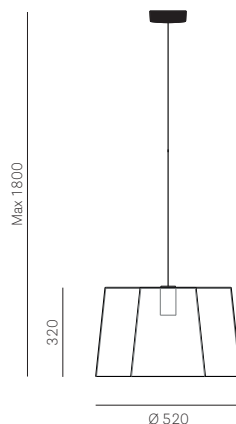

L001SW/BA

MAX 1x23W E27 220-240V

CE IP 20

€ 208,00 (TR, FU)



Cable length 1,5 m
Lunghezza cavo 1,5 m

DIFFUSER COLOURS / Colori diffusore

Transparent



TR
Clear
transparent
Trasparente



FU
Smoky grey
Fumé



RT
Transparent
red
Rosso
trasparente

Full colour



BI*
White
Bianco

*For diffuser A
Solo per diffusore A

Soft-touch powder coating Verniciato finitura soft-touch



BE
Beige



GA
Anthracite
Grey
Grigio
antracite



RM
Copper
Rame



NS
Black
Nero

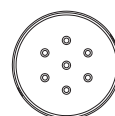

Ø 131



42

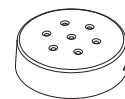

CEILING ROSE AND CABLE COLOUR / Colore rosone e cavo



Matt black
Nero opaco

Minimum order quantity: 4 hanging lamps / Ordine minimo: 4 lampade a sospensione

The device is compatible with bulbs of the following energy classes: from B to A++ / Questo dispositivo è compatibile con lampadine di classi energetiche: da B a A++

Price doesn't include light bulb / La lampadina non è compresa nel prezzo

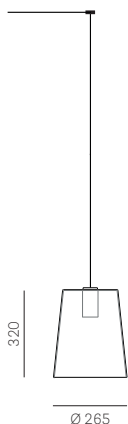

L001CW/A_3

MAX 1x23W E27 220-240V

€ IP 20

€ 137,00 (TR, FU, RT, VL)

€ 186,00 (BE, GA, RM, NS, VE)



Cable length 3 m, 2 cable clamp
Lunghezza cavo 3 m, 2 fissacavi

L001CW/A_6

MAX 1x23W E27 220-240V

€ IP 20

€ 181,00 (TR, FU, RT, VL)

€ 232,00 (BE, GA, RM, NS, VE)



Cable length 6 m, 4 cable clamp
Lunghezza cavo 6 m, 4 fissacavi

L001CW/A_8

MAX 1x23W E27 220-240V

€ IP 20

€ 205,00 (TR, FU, RT, VL)

€ 254,00 (BE, GA, RM, NS, VE)



Cable length 8 m, 5 cable clamp
Lunghezza cavo 8 m, 5 fissacavi

DIFFUSER COLOURS / Colori diffusore

Transparent

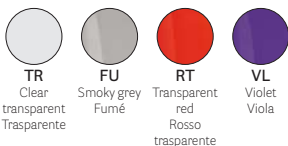

Soft-touch powder coating Verniciato finitura soft-touch

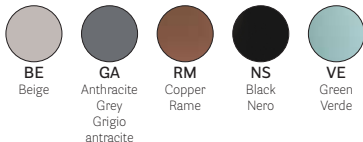

KIT_RNE (Ceiling rose and support kit):
surcharge € 29,00 (wiring to be done by the customer)
KIT_RNE (kit rosone e supporto):
supplemento € 29,00 (cablaggio elettrico a cura del cliente)



ME/00133
PLUG KIT (Europe plug version C: surcharge € 29,00)
KIT_SPINA (Europea tipo C: supplemento € 29,00)



Minimum order quantity: 4 hanging lamps / Ordine minimo: 4 lampade a sospensione

The device is compatible with bulbs of the following energy classes: from B to A++ / Questo dispositivo è compatibile con lampadine di classi energetiche: da B a A++

Price doesn't include light bulb / La lampadina non è compresa nel prezzo

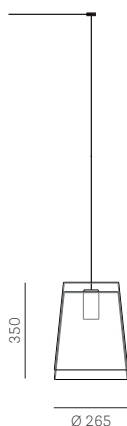

L001CW/AA_3

MAX 1x23W E27 220-240V

€ IP 20

€ 186,00 (TR, FU, RT)



Cable length 3 m, 2 cable clamp
Lunghezza cavo 3 m, 2 fissacavi

L001CW/AA_6

MAX 1x23W E27 220-240V

€ IP 20

€ 232,00 (TR, FU, RT)



Cable length 6 m, 4 cable clamp
Lunghezza cavo 6 m, 4 fissacavi

L001CW/AA_8

MAX 1x23W E27 220-240V

€ IP 20

€ 254,00 (TR, FU, RT)



Cable length 8 m, 5 cable clamp
Lunghezza cavo 8 m, 5 fissacavi

DIFFUSER COLOURS / Colori diffusore

Transparent

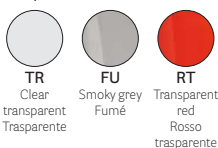

TR
Clear
transparent
Trasparente

FU
Smoky grey
Fumé

RT
Transparent
red
Rosso
trasparente

Full colour



BI*
White
Bianco

*For inner diffuser A
Solo per diffusore interno A

KIT_RNE (Ceiling rose and support kit):

surcharge € 29,00 (wiring to be done by the customer)

KIT_RNE (kit rosone e supporto):

supplemento € 29,00 (cablaggio elettrico a cura del cliente)



ME/00133

PLUG KIT (Europe plug version C: surcharge € 29,00)

KIT SPINA (Europea tipo C: supplemento € 29,00)



Minimum order quantity: 4 hanging lamps / Ordine minimo: 4 lampade a sospensione

The device is compatible with bulbs of the following energy classes: from B to A++ / Questo dispositivo è compatibile con lampadine di classi energetiche: da B a A++

Price doesn't include light bulb / La lampadina non è compresa nel prezzo

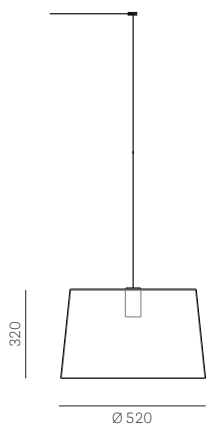

L001CW/B_3

MAX 1x23W E27 220-240V

CE IP 20

€ 186,00 (TR, FU, RT)

€ 258,00 (BE, GA, RM, NS)



Cable length 3 m, 2 cable clamp
Lunghezza cavo 3 m, 2 fissacavi

L001CW/B_6

MAX 1x23W E27 220-240V

CE IP 20

€ 232,00 (TR, FU, RT)

€ 303,00 (BE, GA, RM, NS)



Cable length 6 m, 4 cable clamp
Lunghezza cavo 6 m, 4 fissacavi

L001CW/B_8

MAX 1x23W E27 220-240V

CE IP 20

€ 254,00 (TR, FU, RT)

€ 325,00 (BE, GA, RM, NS)



Cable length 8 m, 5 cable clamp
Lunghezza cavo 8 m, 5 fissacavi

DIFFUSER COLOURS / Colori diffusore

Transparent

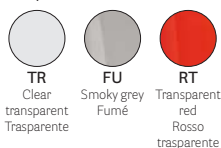

Soft-touch powder coating Verniciato finitura soft-touch



Minimum order quantity: 4 hanging lamps / Ordine minimo: 4 lampade a sospensione

The device is compatible with bulbs of the following energy classes: from B to A++ / Questo dispositivo è compatibile con lampadine di classi energetiche: da B a A++

Price doesn't include light bulb / La lampadina non è compresa nel prezzo

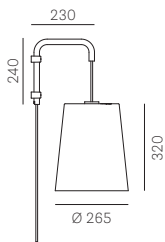

L001W20/A

MAX 1x23W E27 220-240V

€ IP 20

€ 215,00 (TR, FU, BI)

€ 266,00 (BE, GA, RM, NS, VE)



Visible cable length 3 m, 1 cable clamp
Lunghezza cavo a vista 3 m, 1 fissacavo

Surcharge for antique brass frame: € 51,00
Supplemento struttura ottone anticato: € 51,00

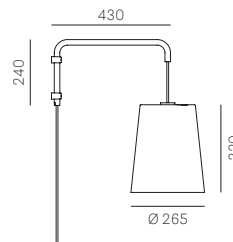

L001W40/A

MAX 1x23W E27 220-240V

€ IP 20

€ 220,00 (TR, FU, BI)

€ 270,00 (BE, GA, RM, NS, VE)



Visible cable length 3 m, 1 cable clamp
Lunghezza cavo a vista 3 m, 1 fissacavo

Surcharge for antique brass frame: € 51,00
Supplemento struttura ottone anticato: € 51,00

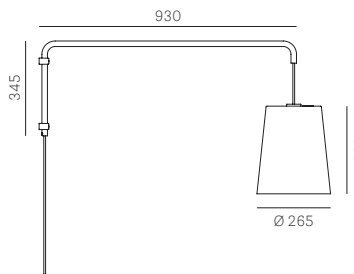

L001W90/A

MAX 1x23W E27 220-240V

€ IP 20

€ 246,00 (TR, FU, BI)

€ 296,00 (BE, GA, RM, NS, VE)



Visible cable length 3 m, 1 cable clamp
Lunghezza cavo a vista 3 m, 1 fissacavo

Surcharge for antique brass frame: € 101,00
Supplemento struttura ottone anticato: € 101,00

DIFFUSER COLOURS / Colori diffusore

Transparent

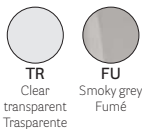

Full colour



**Soft-touch powder coating
Verniciato finitura soft-touch**

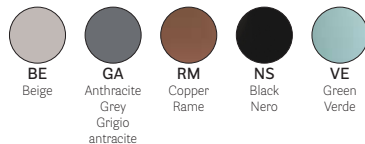

FRAME COLOURS / Colori struttura



CABLE COLOUR / Colore cavo



The device is compatible with bulbs of the following energy classes: from B to A++ / Questo dispositivo è compatibile con lampadine di classi energetiche: da B a A++

Price doesn't include light bulb / La lampadina non è compresa nel prezzo

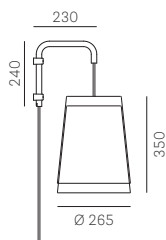
**L001W20/AA**

MAX 1x23W E27 220-240V

CE IP 20 □

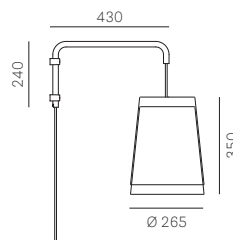
€ 266,00Visible cable length 3 m, 1 cable clamp
Lunghezza cavo a vista 3 m, 1 fissacavoSurcharge for antique brass frame: **€ 51,00**
Supplemento struttura ottone anticato: **€ 51,00****L001W40/AA**

MAX 1x23W E27 220-240V

CE IP 20 □

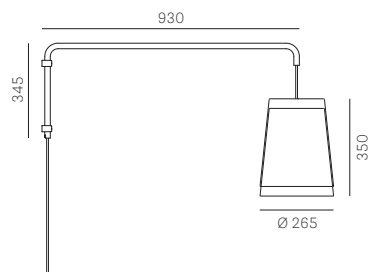
€ 270,00Visible cable length 3 m, 1 cable clamp
Lunghezza cavo a vista 3 m, 1 fissacavoSurcharge for antique brass frame: **€ 51,00**
Supplemento struttura ottone anticato: **€ 51,00****L001W90/AA**

MAX 1x23W E27 220-240V

CE IP 20 □

€ 296,00Visible cable length 3 m, 1 cable clamp
Lunghezza cavo a vista 3 m, 1 fissacavoSurcharge for antique brass frame: **€ 101,00**
Supplemento struttura ottone anticato: **€ 101,00****DIFFUSER COLOURS / Colori diffusore****Transparent****TR**
Clear
transparent
Trasparente**FU**
Smoky grey
Fumè**Full colour****BI***
White
Bianco*For inner diffuser A
Solo per diffusore interno A**FRAME COLOURS / Colori struttura****NEF**
Matt black
Nero opaco**_OA**
Antique brass
Ottone
anticato**CABLE COLOUR / Colore cavo****NEF**
Matt black
Nero opaco

The device is compatible with bulbs of the following energy classes: from B to A++ / Questo dispositivo è compatibile con lampadine di classi energetiche: da B a A++

Price doesn't include light bulb / La lampadina non è compresa nel prezzo

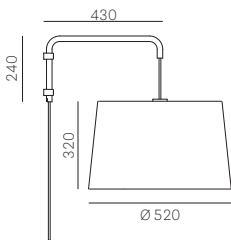

L001W40/B

MAX 1x23W E27 220-240V

CE IP 20

€ 270,00 (TR, FU, BI)

€ 341,00 (BE, GA, RM, NS)



Visible cable length 3 m, 1 cable clamp
Lunghezza cavo a vista 3 m, 1 fissacavo

Surcharge for antique brass frame: € 51,00
Supplemento struttura ottone anticato: € 51,00

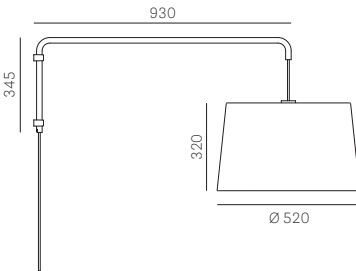

L001W90/B

MAX 1x23W E27 220-240V

CE IP 20

€ 296,00 (TR, FU, BI)

€ 367,00 (BE, GA, RM, NS)



Visible cable length 3 m, 1 cable clamp
Lunghezza cavo a vista 3 m, 1 fissacavo

Surcharge for antique brass frame: € 101,00
Supplemento struttura ottone anticato: € 101,00

DIFFUSER COLOURS / Colori diffusore

Transparent



TR
Clear transparent
Trasparente



FU
Smoky grey
Fumé

Full colour



BI
White
Bianco

Soft-touch powder coating
Verniciato finitura soft-touch



BE
Beige



GA
Anthracite Grey
Grigio antracite



RM
Copper
Rame



NS
Black
Nero

FRAME COLOURS / Colori struttura



NEF
Matt black
Nero opaco



_OA
Antique brass
Ottone anticato

CABLE COLOUR / Colore cavo



NEF
Matt black
Nero opaco

The device is compatible with bulbs of the following energy classes: from B to A++ / Questo dispositivo è compatibile con lampadine di classi energetiche: da B a A++

Price doesn't include light bulb / La lampadina non è compresa nel prezzo

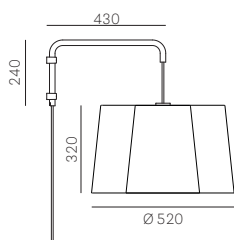

L001W40/BA

MAX 1x23W E27 220-240V

CE IP 20

€ 320,00



Visible cable length 3 m, 1 cable clamp
Lunghezza cavo a vista 3 m, 1 fissacavo

Surcharge for antique brass frame: € 51,00
Supplemento struttura ottone anticato: € 51,00

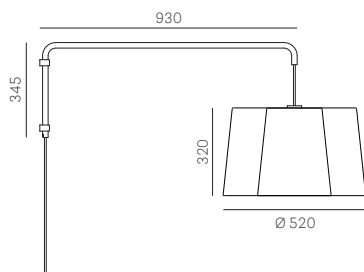

L001W90/BA

MAX 1x23W E27 220-240V

CE IP 20

€ 346,00



Visible cable length 3 m, 1 cable clamp
Lunghezza cavo a vista 3 m, 1 fissacavo

Surcharge for antique brass frame: € 101,00
Supplemento struttura ottone anticato: € 101,00

DIFFUSER COLOURS / Colori diffusore

Transparent



TR
Clear transparent
Trasparente



FU
Smoky grey
Fumé

Full colour



BI*
White
Bianco

*For diffuser A
Solo per diffusore A

FRAME COLOURS / Colori struttura



NEF
Matt black
Nero opaco



_OA
Antique brass
Ottone anticato

CABLE COLOUR / Colore cavo



NEF
Matt black
Nero opaco

The device is compatible with bulbs of the following energy classes: from B to A++ / Questo dispositivo è compatibile con lampadine di classi energetiche: da B a A++

Price doesn't include light bulb / La lampadina non è compresa nel prezzo

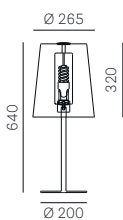

L001TA/A
 MAX 1x100W E27 220-240V
 CE IP 20 
€ 257,00

L001TA/A_UK
 English plug version
 Versione con presa britannica
€ 299,00

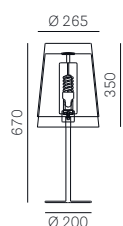

L001TA/AA
 MAX 1x100W E27 220-240V
 CE IP 20 
€ 293,00

L001TA/AA_UK
 English plug version
 Versione con presa britannica
€ 336,00



L001TA/A

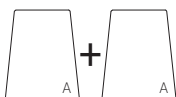

L001TA/AA*



*Inner diffuser = colour BI only
 Diffusore interno = solo colore BI

DIFFUSER COLOURS / Colori diffusore

Transparent



Full colour



BASE COLOURS / Colori base



The device is provided with bulb of energy class: A+ / Il dispositivo è venduto con una lampadina di classe energetica: A+

Price includes light bulb / La lampadina è compresa nel prezzo
 L001TA: LED 14W 2700*K

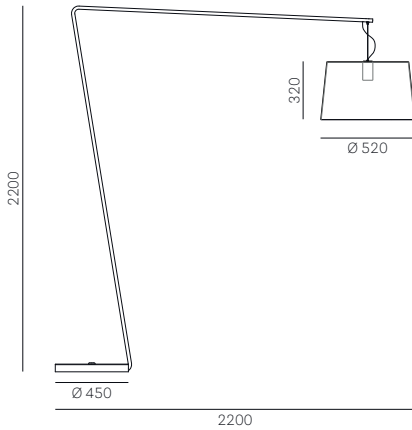

L001T/B
 MAX 1x100W E27 220-240V
 CE IP 20

€ 851,00

L001T/B_UK
 English plug version
 Versione con presa britannica

€ 894,00

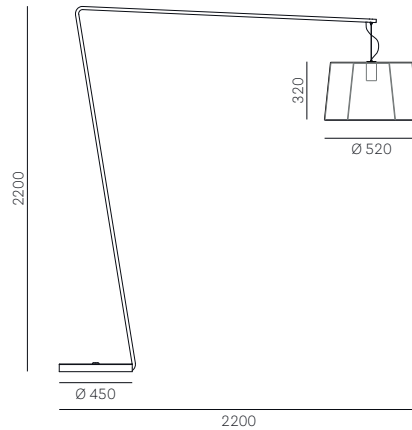

L001T/BA
 MAX 1x100W E27 220-240V
 CE IP 20

€ 900,00

L001T/BA_UK
 English plug version
 Versione con presa britannica

€ 943,00



L001T/B

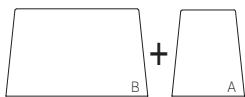

L001T/BA*

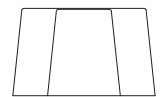

*Inner diffuser = colour BI only
 Diffusore interno = solo colore BI

DIFFUSER COLOURS / Colori diffusore

Transparent

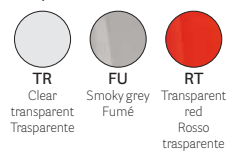

Full colour



BASE COLOURS / Colori base



The device is compatible with bulbs of the following energy classes: from E to A++ / Questo dispositivo è compatibile con lampadine di classi energetiche: da E a A++

Price doesn't include light bulb / La lampadina non è compresa nel prezzo

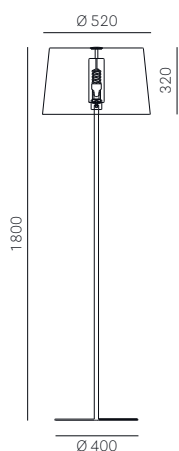

L001ST/B

MAX 1x100W E27 220-240V

CE IP 20

€ 504,00 (BE)

L001ST/B_UK

English plug version
Versione con presa britannica

€ 546,00 (BE)



Surcharge for antique brass frame: € 143,00
Supplemento struttura ottone anticato: € 143,00

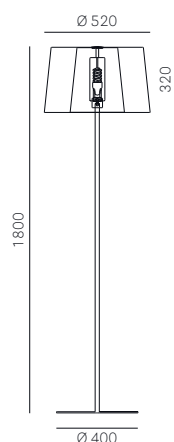

L001ST/BA

MAX 1x100W E27 220-240V

CE IP 20

€ 403,00 (TR, FU)

L001ST/BA_UK

English plug version
Versione con presa britannica

€ 446,00 (TR, FU)



Surcharge for antique brass frame: € 143,00
Supplemento struttura ottone anticato: € 143,00



L001ST/B



+



L001ST/BA*

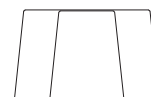

*Inner diffuser = colour BI only
Diffusore interno = solo colore BI

DIFFUSER COLOURS / Colori diffusore

Transparent



TR
Clear
transparent
Trasparente



FU
Smoky grey
Fumé

Full colour



BI*
White
Bianco

*For diffuser A
Solo per diffusore A

Soft-touch powder coating Verniciato finitura soft-touch



BE
Beige

BASE COLOURS / Colori base



_BI300
White
Bianco



_NERO
Black
Nero



_BE200
Beige



_OA
Antique brass
Ottone anticato

The device is provided with bulb of energy class: A+ / Il dispositivo è venduto con una lampadina di classe energetica A+

Price includes light bulb / La lampadina è compresa nel prezzo
L001ST: LED 14W 2700°K

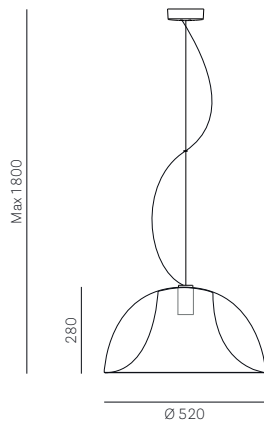

L002S/BA

MAX 1x75W E27 220-240V

CE IP 20

€ 201,00



Cable length > 4m: upcharge € 29,00
Lunghezza cavo > 4m: supplemento € 29,00



*Inner diffuser = colour BI only
Diffusore interno = solo colore BI

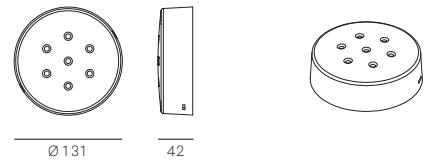

CEILING ROSE COLOUR / Colore rosone



Black colour fitting version (item RN): upcharge € 8,00
Versione con rosone colore nero (art. RN): supplemento € 8,00

DIFFUSER B COLOURS / Colori diffusore B

Transparent

Full colour

Powder coating
Verniciato



TR
Clear transparent
Trasparente

RT
Transparent red
Rosso trasparente

BI
White
Bianco

NS
Matt black
Nero opaco

Minimum order quantity: 4 hanging lamps / Ordine minimo: 4 lampade a sospensione

The device is compatible with bulbs of the following energy classes: from E to A++ / Questo dispositivo è compatibile con lampadine di classi energetiche: da E a A++

Price doesn't include light bulb / La lampadina non è compresa nel prezzo

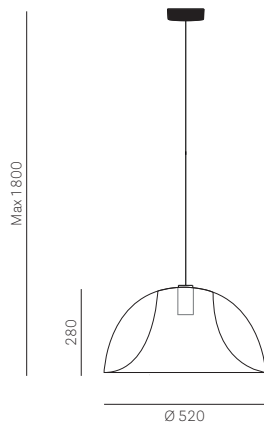

L002SW/BA

MAX 1x23W E27 220-240V

CE IP 20

€ 215,00 (TR)

€ 340,00 (GA)



MC 0,097

Cable length 1,5 m
Lunghezza cavo 1,5 m

DIFFUSER COLOURS / Colori diffusore

Transparent



TR
Clear
transparent
Trasparente

Full colour



BI*
White
Bianco

*For diffuser A
Solo per diffusore A

Soft-touch powder coating

Verniciato finitura soft-touch



GA
Anthracite
Grey
Grigio
antracite

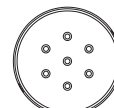

Ø 131



42

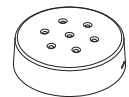

CEILING ROSE AND CABLE COLOUR / Colore rosone e cavo



Matt black
Nero opaco

Minimum order quantity: 4 hanging lamps / Ordine minimo: 4 lampade a sospensione

The device is compatible with bulbs of the following energy classes: from B to A++ / Questo dispositivo è compatibile con lampadine di classi energetiche: da B a A++

Price doesn't include light bulb / La lampadina non è compresa nel prezzo

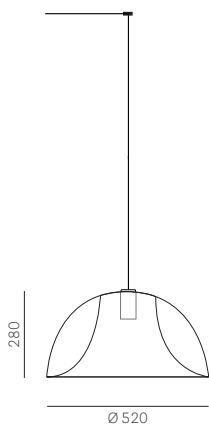
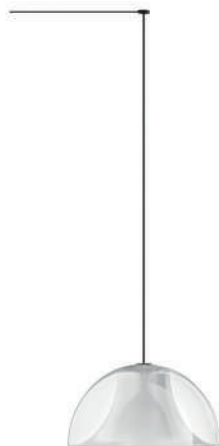

L002CW/BA_3

MAX 1x23W E27 220-240V

€ IP 20

€ 244,00 (TR)

€ 368,00 (GA)



Cable length 3 m, 2 cable clamp
Lunghezza cavo 3 m, 2 fissacavi

L002CW/BA_6

MAX 1x23W E27 220-240V

€ IP 20

€ 289,00 (TR)

€ 413,00 (GA)



Cable length 6 m, 4 cable clamp
Lunghezza cavo 6 m, 4 fissacavi

L002CW/BA_8

MAX 1x23W E27 220-240V

€ IP 20

€ 311,00 (TR)

€ 436,00 (GA)



Cable length 8 m, 5 cable clamp
Lunghezza cavo 8 m, 5 fissacavi

DIFFUSER COLOURS / Colori diffusore

Transparent



TR
Clear
transparent
Trasparente

Full colour



BI*
White
Bianco

*For diffuser A only
Solo per diffusore A

Soft-touch powder coating Verniciato finitura soft-touch



GA
Anthracite
Grey
Grigio
antracite

Minimum order quantity: 4 hanging lamps / Ordine minimo: 4 lampade a sospensione

The device is compatible with bulbs of the following energy classes: from B to A++ / Questo dispositivo è compatibile con lampadine di classi energetiche: da B a A++

Price doesn't include light bulb / La lampadina non è compresa nel prezzo

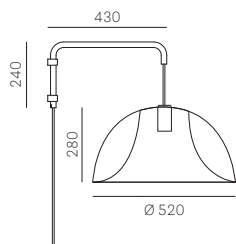

L002W40/BA

MAX 1x23W E27 220-240V

CE IP 20

€ 327,00 (TR)

€ 452,00 (GA)



Visible cable length 3 m, 1 cable clamp
Lunghezza cavo a vista 3 m, 1 fissacavo

Surcharge for antique brass frame: € 51,00
Supplemento struttura ottone anticato: € 51,00

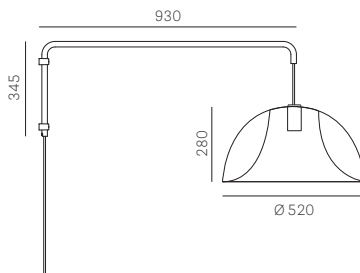

L002W90/BA

MAX 1x23W E27 220-240V

CE IP 20

€ 353,00 (TR)

€ 478,00 (GA)



Visible cable length 3 m, 1 cable clamp
Lunghezza cavo a vista 3 m, 1 fissacavo

Surcharge for antique brass frame: € 101,00
Supplemento struttura ottone anticato: € 101,00

DIFFUSER COLOURS / Colori diffusore

Transparent



TR
Clear
transparent
Trasparente

Full colour



BI
White
Bianco

*For diffuser A
Solo per diffusore A

Soft-touch powder coating
Verniciato finitura soft-touch



GA
Anthracite
Grey
Grigio
antracite

FRAME COLOURS / Colori struttura



NEF
Matt black
Nero opaco



_OA
Antique brass
Ottone
anticato

CABLE COLOUR / Colore cavo



NEF
Matt black
Nero opaco

The device is compatible with bulbs of the following energy classes: from B to A++ / Questo dispositivo è compatibile con lampadine di classi energetiche: da B a A++

Price doesn't include light bulb / La lampadina non è compresa nel prezzo

L002T - L002ST

VAT NOT INCLUDED / Iva esclusa

Lighting / Lampade

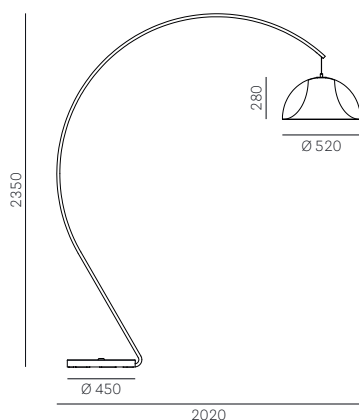
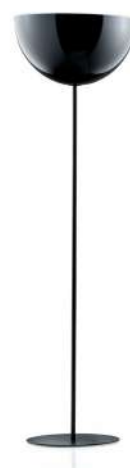
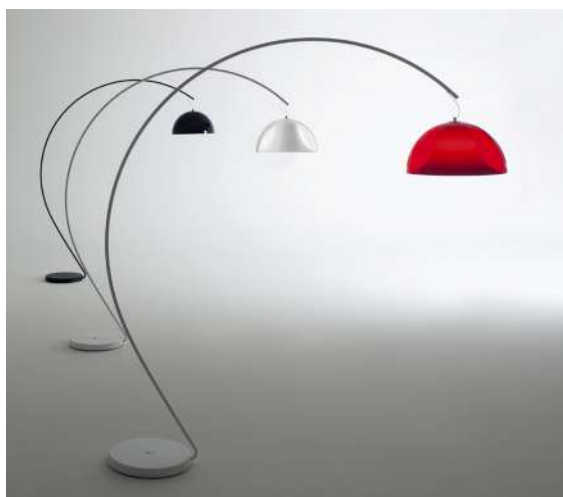

L002T/BA
 MAX 1x100W E27 220-240V
 € IP 20
€ 857,00

L002T/BA_UK
 English plug version
 Versione con presa britannica
€ 900,00

1 pc MC 0,55

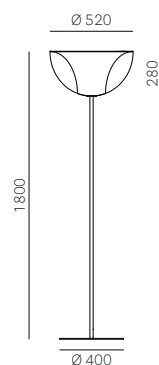

L002ST/BA
 MAX 1x100W E27 220-240V
 € IP 20
€ 403,00

L002ST/BA_UK
 English plug version
 Versione con presa britannica
€ 446,00

1 pc MC 0,17

Surcharge for antique brass frame: **€ 143,00**
 Supplemento struttura ottone anticato: **€ 143,00**



L002T/BA*
L002ST/BA*

*Inner diffuser = colour BI only
 Diffusore interno = solo colore BI

L002T/BA
 DIFFUSER B COLOURS / Colori diffusore B

Transparent

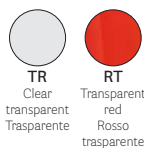

Full colour



Powder coating



BASE COLOURS / Colori base



L002ST/BA
 DIFFUSER B COLOURS / Colori diffusore B

Full colour



Powder coating



BASE COLOURS / Colori base

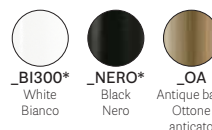

* White diffuser combined with white or antique brass base
 Black diffuser combined with black or antique brass base
 Diffusore bianco abbinato alla base bianca oppure ottone anticato
 Diffusore nero abbinato alla base nera oppure ottone anticato

The device is compatible with bulbs of the following energy classes: from E to A++
 Questo dispositivo è compatibile con lampadine di classi energetiche: da E a A++

Price doesn't include light bulb / La lampadina non è compresa nel prezzo

The device is provided with bulb of energy class: A+
 Il dispositivo è venduto con una lampadina di classe energetica: A+

Price includes light bulb / La lampadina è compresa nel prezzo
 L002ST/BA: LED 14W 2700°K

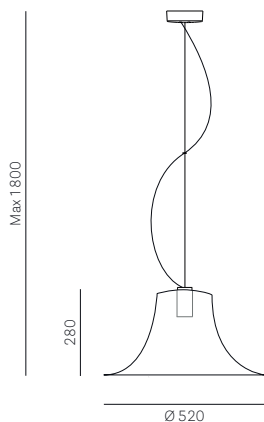

L004S/A

MAX 1x75W E27 220-240V

CE IP 20

€ 228,00



Cable length > 4m: upcharge **€ 29,00**
Lunghezza cavo > 4m: supplemento **€ 29,00**

DIFFUSER COLOURS / Colori diffusore

Soft-touch powder coating
Verniciato finitura soft-touch

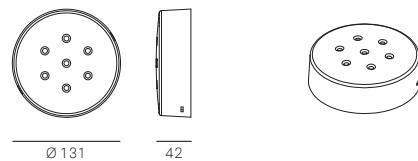
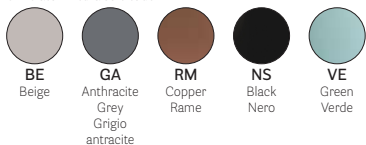

CEILING ROSE COLOUR / Colore rosone



Black colour fitting version (item RN): upcharge **€ 8,00**
Versione con rosone colore nero (art. RN): supplemento **€ 8,00**

Minimum order quantity: 4 hanging lamps / Ordine minimo: 4 lampade a sospensione

The device is compatible with bulbs of the following energy classes: from E to A++ / Questo dispositivo è compatibile con lampadine di classi energetiche: da E a A++

Price doesn't include light bulb / La lampadina non è compresa nel prezzo

L004SW

VAT NOT INCLUDED / Iva esclusa

Lighting / Lampade

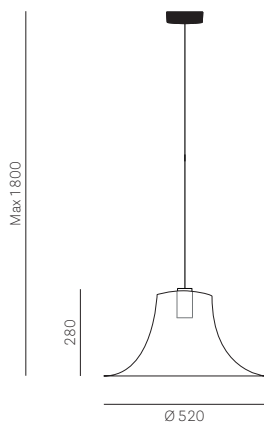
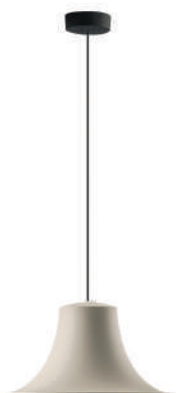

L004SW/A

MAX 1x23W E27 220-240V

CE IP 20

€ 242,00



MC 0,10

Cable length 1,5 m
Lunghezza cavo 1,5 m

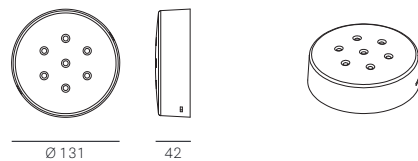

Ø 131

42

DIFFUSER COLOURS / Colori diffusore

Soft-touch powder coating
Verniciato finitura soft-touch

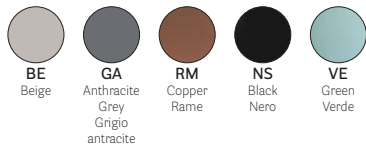

BE

Beige

GA

Anthracite
Grey
Grigio
antracite

RM

Copper
Rame

NS

Black
Nero

VE

Green
Verde

CEILING ROSE AND CABLE COLOUR / Colore rosone e cavo



Matt black
Nero opaco

Minimum order quantity: 4 hanging lamps / Ordine minimo: 4 lampade a sospensione

The device is compatible with bulbs of the following energy classes: from B to A++ / Questo dispositivo è compatibile con lampadine di classi energetiche: da B a A++

Price doesn't include light bulb / La lampadina non è compresa nel prezzo

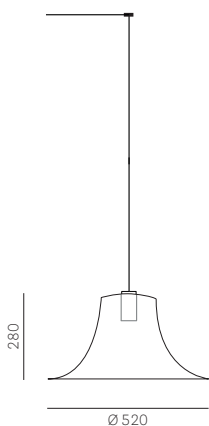
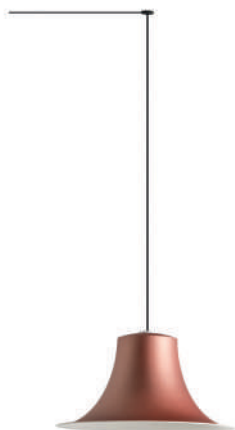

L004CW/A_3

MAX 1x23W E27 220-240V

CE IP 20

€ 271,00



Cable length 3 m, 2 cable clamp
Lunghezza cavo 3 m, 2 fissacavi

L004CW/A_6

MAX 1x23W E27 220-240V

CE IP 20

€ 315,00



Cable length 6 m, 4 cable clamp
Lunghezza cavo 6 m, 4 fissacavi

L004CW/A_8

MAX 1x23W E27 220-240V

CE IP 20

€ 338,00



Cable length 8 m, 5 cable clamp
Lunghezza cavo 8 m, 5 fissacavi

DIFFUSER COLOURS / Colori diffusore

Soft-touch powder coating
Verniciato finitura soft-touch

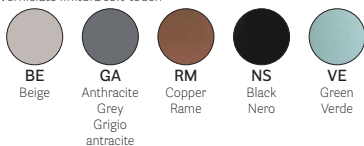

Minimum order quantity: 4 hanging lamps / Ordine minimo: 4 lampade a sospensione

The device is compatible with bulbs of the following energy classes: from B to A++ / Questo dispositivo è compatibile con lampadine di classi energetiche: da B a A++

Price doesn't include light bulb / La lampadina non è compresa nel prezzo

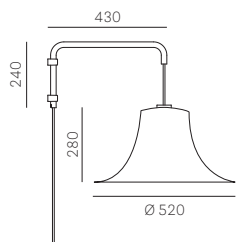

L004W40/A

MAX 1x23W E27 220-240V

CE IP 20

€ 354,00



Visible cable length 3 m, 1 cable clamp
Lunghezza cavo a vista 3 m, 1 fissacavo

Surcharge for antique brass frame: € 51,00
Supplemento struttura ottone anticato: € 51,00

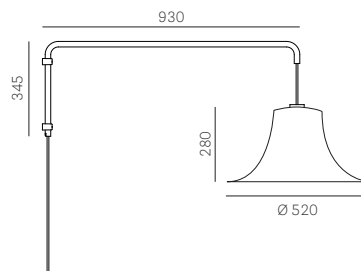

L004W90/A

MAX 1x23W E27 220-240V

CE IP 20

€ 380,00



Visible cable length 3 m, 1 cable clamp
Lunghezza cavo a vista 3 m, 1 fissacavo

Surcharge for antique brass frame: € 101,00
Supplemento struttura ottone anticato: € 101,00

DIFFUSER COLOURS / Colori diffusore

Soft-touch powder coating
Verniciato finitura soft-touch

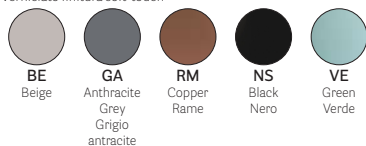

FRAME COLOURS / Colori struttura



CABLE COLOUR / Colore cavo



The device is compatible with bulbs of the following energy classes: from B to A++ / Questo dispositivo è compatibile con lampadine di classi energetiche: da B a A++

Price doesn't include light bulb / La lampadina non è compresa nel prezzo

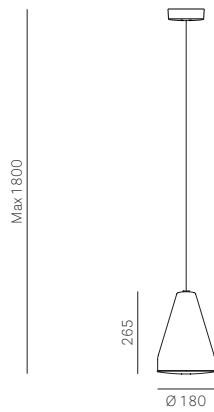

L005S/A

MAX 1x23W E27 220-240V

CE IP 20

€ 194,00

€ 260,00 (OS, RM2)



Cable length 1,5 m
Lunghezza cavo 1,5 m

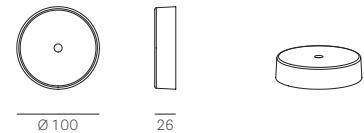

DIFFUSER COLOURS / Colori diffusore

Powder coating
Verniciato



NEF Black
Nero soft-touch

GA Anthracite grey
Grigio antracite

BE200 Beige

BI200 White
Bianco



OS Brass
Ottone

RM2 Copper
Rame



RA200 Pink
Rosa

TE Terracotta

GI200 Yellow
Giallo

VE100 Green
Verde

CEILING ROSE AND CABLE COLOUR / Colore rosone e cavo



Matt black
Nero opaco

Matt white
Bianco opaco

Minimum order quantity: 4 hanging lamps / Ordine minimo: 4 lampade a sospensione

The device provided with bulb of energy class: A+ / Il dispositivo è venduto con una lampadina di classe energetica A+

Price includes light bulb / La lampadina è compresa nel prezzo
L005S/A: LED 13W 3000°K

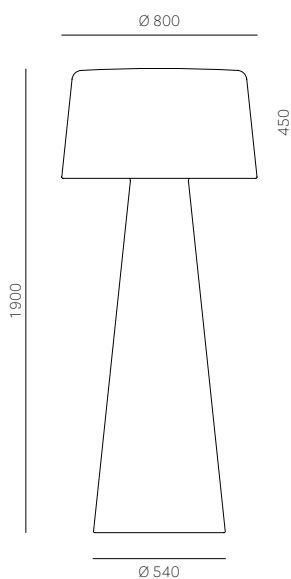

T_OUT/BI_LUCE

MAX 2x27W E27 220-240V

CE IP 44

€ 985,00

1 pc MC 1,27

T_OUT_FIX

Floor fixing kit: upcharge **€ 114,00**

Kit per il fissaggio a terra: supplemento **€ 114,00**

COLOUR / Colore



BI

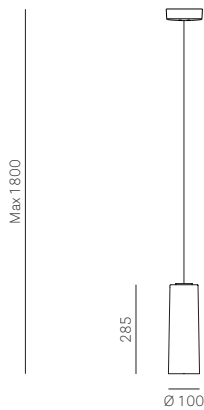

L006S/A
 MAX 1x23W E27 220-240V
 CE IP 20
€ 141,00



Cable length 1,5 m
 Lunghezza cavo 1,5 m

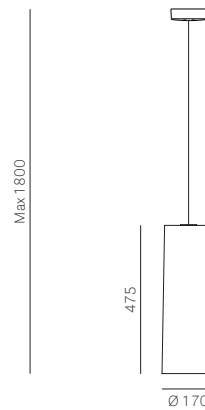

L006SW/B
 MAX 1x23W E27 220-240V
 CE IP 20
€ 185,00



Cable length 1,5 m
 Lunghezza cavo 1,5 m

L006S/A

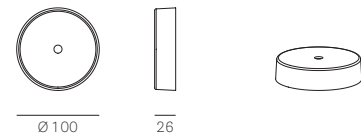

L006SW/B

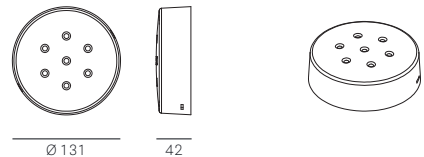

DIFFUSER COLOURS / Colori diffusore

Soft-touch powder coating
 Verniciato finitura soft-touch



NS
 Black
 Nero

Powder coating
 Verniciato



B1200
 White
 Bianco



BE200
 Beige



OR2
 Pink brass
 Ottone rosa

CEILING ROSE AND CABLE COLOUR / Colore rosone e cavo



Matt black
 Nero
 opaco



* Matt white
 Bianco
 opaco

* L006S/A only
 Solo L006S/A

Minimum order quantity: 4 hanging lamps / Ordine minimo: 4 lampade a sospensione

The device is compatible with bulbs of the following energy classes: from B to A++ / Questo dispositivo è compatibile con lampadine di classi energetiche: da B a A++

Price doesn't include light bulb / La lampadina non è compresa nel prezzo

Finishes / Finiture

Steel and stainless steel / Acciaio e acciaio inox

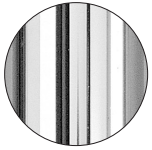

CR
Chromed steel
Acciaio cromato



ST
Satinized steel
Acciaio satinato

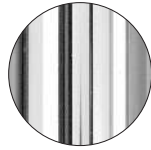

LU
Polished s/steel
Acciaio inox lucidato

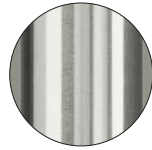

AC
Brushed s/steel
Acciaio inox satinato

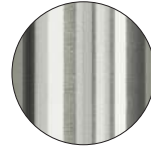

AC 316
Brushed s/steel AISI 316
for outdoor
Acciaio inox AISI 316 per
esterno



BS
Antique bronze steel
Acciaio bronzo anticato



OA
Antique brass steel
Acciaio ottone anticato

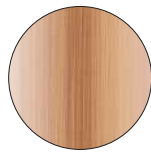

RM
Antique copper steel
Acciaio rame anticato



EC
Corten steel
Acciaio effetto Corten

Gold lacquered / Laccato oro



VOR

Aluminium / Alluminio



LU
Polished aluminium
Alluminio lucidato

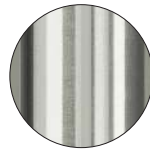

AS
Satinized aluminium
Alluminio satinato

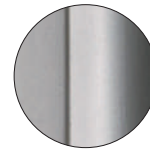

AA
Anodized aluminium
Alluminio anodizzato



TN
Titanium
Titanio

Beech / Faggio

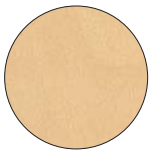

FS
Bleached beech
Faggio sbiancato



W
Wenge
Wengé

Oak / Rovere



RS
Bleached oak
Rovere sbiancato



W
Wenge
Wengé

Colours are indicative. Pedrali reserves the right to modify or upgrade the product without prior notice.
I colori sono indicativi. Pedrali si riserva la facoltà di apportare modifiche o migliorie senza alcun preavviso.

Outdoor finishes / Finiture per esterno



Powder coated cast-iron, steel and aluminium / Ghisa, acciaio e alluminio verniciato



BI100E
White,
textured-matt finish
Bianco,
finitura goffrata-opaca



BI200E
White,
textured-matt finish
Bianco,
finitura goffrata-opaca

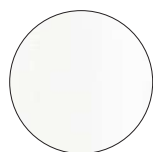

BI300E
White,
smooth-matt finish
Bianco,
finitura liscia-opaca

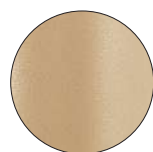

SA100E
Sand,
textured-matt finish
Sabbia,
finitura goffrata-opaca



SA200E
Sand,
textured-matt finish
Sabbia,
finitura goffrata-opaca

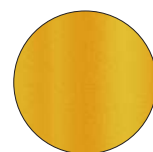

GI100E
Yellow,
textured-matt finish
Giallo,
finitura goffrata-opaca

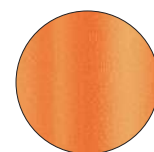

AR200E
Orange,
textured-matt finish
Arancio,
finitura goffrata-opaca

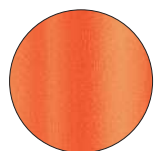

AR500E
Orange,
textured-matt finish
Arancio,
finitura goffrata-opaca

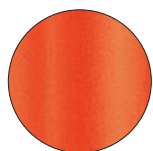

AR400E
Orange,
textured-matt finish
Arancio,
finitura goffrata-opaca

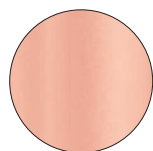

RA100E
Pink,
textured-matt finish
Rosa,
finitura goffrata-opaca

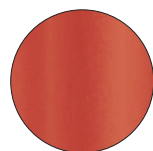

RO400E
Red,
textured-matt finish
Rosso,
finitura goffrata-opaca

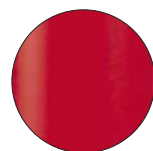

RO200E
Red,
textured-matt finish
Rosso,
finitura goffrata-opaca

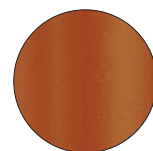

TEE
Terracotta,
textured-matt finish
Terracotta,
finitura goffrata-opaca



RUE
Rust,
textured-matt finish
Ruggine,
finitura goffrata-opaca



MGE
Brown,
textured-matt finish
Marrone,
finitura goffrata-opaca

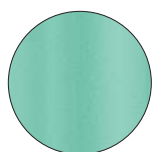

AZ100E
Light blue,
textured-matt finish
Azzurro,
finitura goffrata-opaca

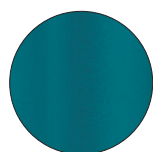

BL500E
Blue,
textured-matt finish
Blu,
finitura goffrata-opaca

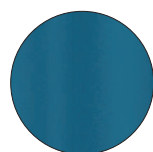

BL300E
Blue,
textured-matt finish
Blu,
finitura goffrata-opaca



BL400E
Blue,
textured-matt finish
Blu,
finitura goffrata-opaca

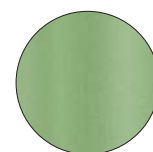

VE100E
Sage green,
textured-matt finish
Verde salvia,
finitura goffrata-opaca

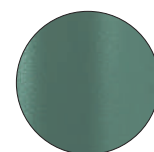

VE600E
Green,
textured-matt finish
Verde,
finitura goffrata-opaca



VE300E
Forest green soft-touch,
smooth-matt finish
Verde bosco soft-touch,
finitura liscia-opaca



6005E
Green,
smooth-glossy finish
Verde,
finitura liscia-lucida

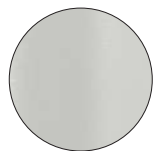

BE100E
Beige,
textured-matt finish
Beige,
finitura goffrata-opaca



BE200E
Beige,
textured-matt finish
Beige,
finitura goffrata-opaca

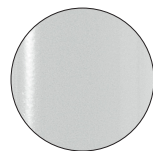

ALE
Aluminium,
smooth-glossy finish
Alluminio,
finitura liscia-lucida

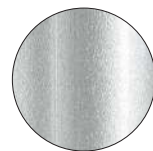

9007E
Aluminium,
smooth-matt finish
Alluminio,
finitura liscia-opaca

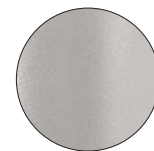

AGE
Aluminium,
textured-matt finish
Alluminio,
finitura goffrata-opaca



GAE
Anthracite grey,
textured-matt finish
Grigio antracite,
finitura goffrata-opaca



GNE
Natural grey,
textured-matt finish
Grigio naturale,
finitura goffrata-opaca



NPE
Black,
textured-matt finish
Nero,
finitura goffrata-opaca

Colours are indicative. Pedrali reserves the right to modify or upgrade the product without prior notice.
I colori sono indicativi. Pedrali si riserva la facoltà di apportare modifiche o migliorie senza alcun preavviso.

Indoor finishes / Finiture per interno

Powder coated cast-iron, steel and aluminium / Ghisa, acciaio e alluminio verniciato



BI100

White,
textured-matt finish
Bianco,
finitura goffrata-opaca



BI200

White,
textured-matt finish
Bianco,
finitura goffrata-opaca

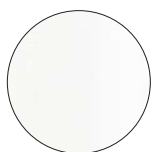

BI300

White,
smooth-matt finish
Bianco,
finitura liscia-opaca

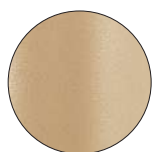

SA100

Sand,
textured-matt finish
Sabbia,
finitura goffrata-opaca



SA200

Sand,
textured-matt finish
Sabbia,
finitura goffrata-opaca

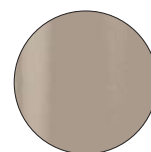

SA300

Sand,
hammered-glossy finish
Sabbia,
finitura bucciata-lucida

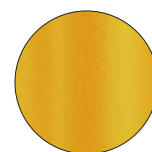

GI100

Yellow,
textured-matt finish
Giallo,
finitura goffrata-opaca

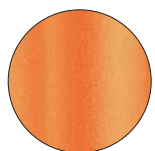

AR200

Orange,
textured-matt finish
Arancio,
finitura goffrata-opaca

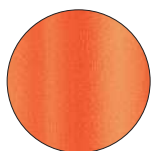

AR500

Orange,
textured-matt finish
Arancio,
finitura goffrata-opaca

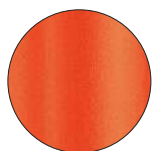

AR400

Orange,
textured-matt finish
Arancio,
finitura goffrata-opaca

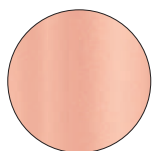

RA100

Pink,
textured-matt finish
Rosa,
finitura goffrata-opaca

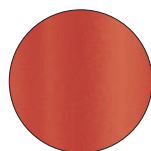

RO400

Red,
textured-matt finish
Rosso,
finitura goffrata-opaca

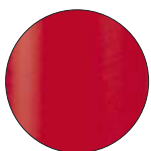

RO200

Red,
textured-matt finish
Rosso,
finitura goffrata-opaca

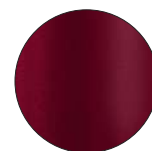

RO300

Red,
textured-matt finish
Rosso,
finitura goffrata-opaca

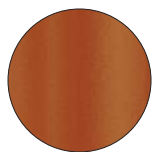

TE

Terracotta,
textured-matt finish
Terracotta,
finitura goffrata-opaca



RU

Rust,
textured-matt finish
Ruggine,
finitura goffrata-opaca



MG

Brown,
textured-matt finish
Marrone,
finitura goffrata-opaca

Colours are indicative. Pedrali reserves the right to modify or upgrade the product without prior notice.
I colori sono indicativi. Pedrali si riserva la facoltà di apportare modifiche o migliorie senza alcun preavviso.

Indoor finishes / Finiture per interno

Powder coated cast-iron, steel and aluminium / Ghisa, acciaio e alluminio verniciato

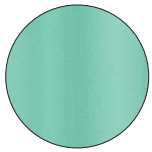

AZ100
Light blue,
textured-matt finish
Azzurro,
finitura goffrata-opaca

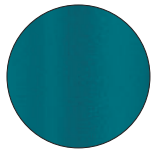

BL500
Blue,
textured-matt finish
Blu,
finitura goffrata-opaca

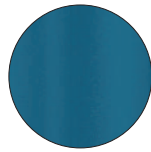

BL300
Blue,
textured-matt finish
Blu,
finitura goffrata-opaca



BL400
Blue,
textured-matt finish
Blu,
finitura goffrata-opaca

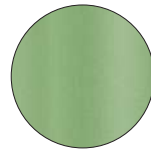

VE100
Sage green,
textured-matt finish
Verde salvia,
finitura goffrata-opaca

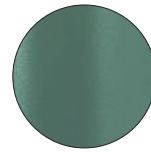

VE600
Green,
textured-matt finish
Verde,
finitura goffrata-opaca



VE300
Forest green soft-touch,
smooth-matt finish
Verde bosco soft-touch,
finitura liscia-opaca



6005
Green,
smooth-glossy finish
Verde,
finitura liscia-lucida

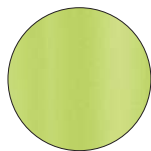

VE400
Green,
textured-matt finish
Verde,
finitura goffrata-opaca

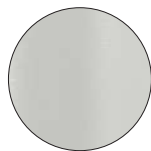

BE100
Beige,
textured-matt finish
Beige,
finitura goffrata-opaca



BE200
Beige,
textured-matt finish
Beige,
finitura goffrata-opaca

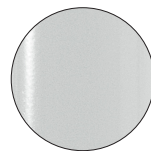

AL
Aluminium,
smooth-glossy finish
Alluminio,
finitura liscia-lucida

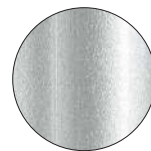

9007
Aluminium,
smooth-matt finish
Alluminio,
finitura liscia-opaca



AG
Aluminium,
textured-matt finish
Alluminio,
finitura goffrata-opaca



GA
Anthracite grey,
textured-matt finish
Grigio antracite,
finitura goffrata-opaca



GN
Natural grey,
textured-matt finish
Grigio naturale,
finitura goffrata-opaca



_NERO
Black,
hammered-matt finish
Nero,
finitura bucciata-opaca

Colours are indicative. Pedrali reserves the right to modify or upgrade the product without prior notice.
I colori sono indicativi. Pedrali si riserva la facoltà di apportare modifiche o migliorie senza alcun preavviso.

Category C

Fire retardant simil leather / Finta pelle ignifuga



C18

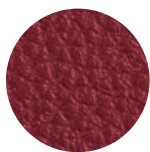

C11

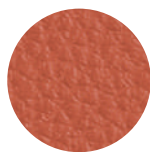

C12

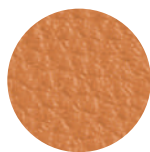

C13

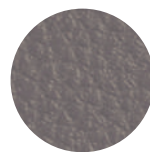

C15

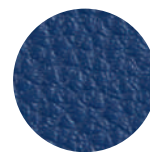

C10

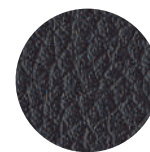

C17



C14



C21

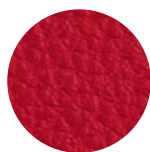

C20



C22

- **FLAME RESISTANCE / RESISTENZA AL FUOCO**
 B2 (DIN 4102)
 BS 5852 Crib 5
 EN 1021.1-2
 EN 13501-1 - Cs3do
 FAR 25853 App F Part 1
 IMO RESOLUTION A.652
 NF D60-013 - AM 18
 NFP 92503 M1
 NY/NJ - Port Authority
 UFAC Fabric Class 1
 German fire standard B1 (except C12 and C22)
 US CATB 117
 US CATB 133

Fire retardant simil leather / Finta pelle ignifuga



C130



C131



C132

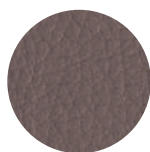

C133



C134

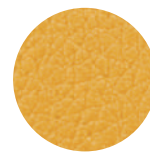

C135

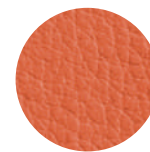

C136

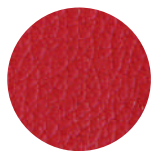

C137

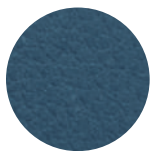

C138

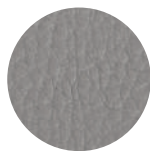

C139



C140



C141

- **FLAME RESISTANCE / RESISTENZA AL FUOCO**
 BS 5852-1 match test
 EN 1021 Part 1-2
 UNI 9175 Classe 1 IM
 US CA TB 117-2013

Colours are indicative. Pedrali reserves the right to modify or upgrade the product without prior notice.
 I colori sono indicativi. Pedrali si riserva la facoltà di apportare modifiche o migliorie senza alcun preavviso.

Fire retardant simil leather / Finta pelle ignifuga

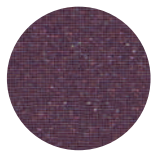

C60

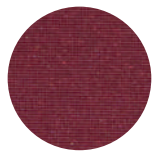

C61

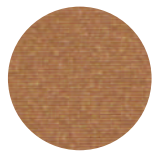

C62

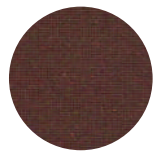

C63

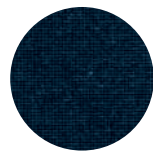

C64

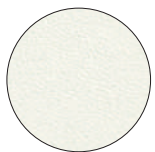

C90



C94



C95



C92

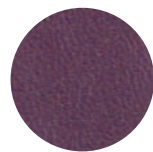

C91

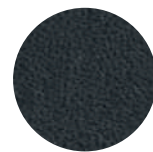

C93

- **FLAME RESISTANCE / RESISTENZA AL FUOCO**
BS 5852-1 Part 1
EN 1021-2
IMO RESOLUTION A.652 (16): 1989
UNI 9175 Classe 1 IM
US CA TB 117-2013

Fabric / Tessuto



C36



C37

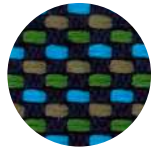

C38

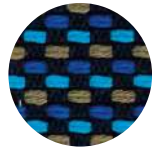

C39

For Kado cushion only
Solo per cuscino Kado

Fire retardant fabric / Tessuto ignifugo

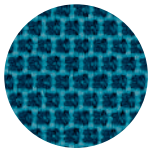

C83

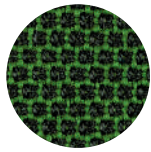

C84

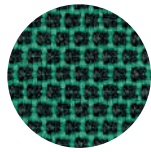

C88

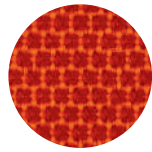

C85

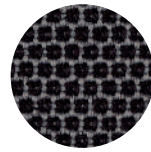

C86

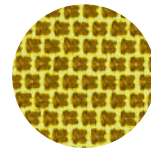

C87

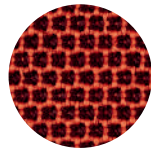

C89

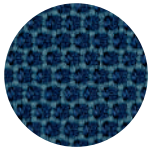

C100



C101

- **FLAME RESISTANCE / RESISTENZA AL FUOCO**
BS EN 1021 1&2
BS EN 1021-1
ÖNORM A3800-1
US CA TB 117-2013



Fire retardant fabric / Tessuto ignifugo

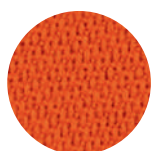

C110

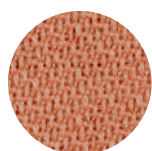

C111



C112



C113

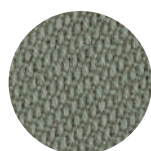

C114

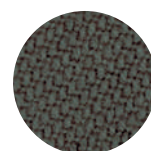

C115



C116

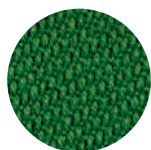

C117

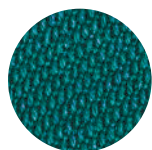

C118

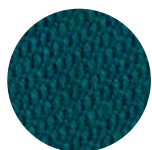

C119

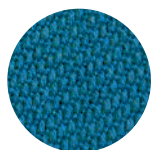

C120

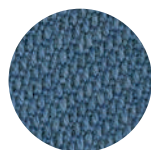

C121

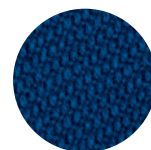

C122

- COLLECTION / COLLEZIONE
 **svensson** - SEMI

- FLAME RESISTANCE / RESISTENZA AL FUOCO
BS 5852 Crib 5
EN ISO 1021 Part 1&2
IMO FTP Code 2010: Part 8
UNI 9175 Classe 1 IM
US CA TB 117-2013



Fire retardant fabric / Tessuto ignifugo

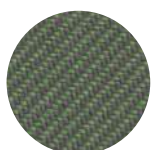

C210

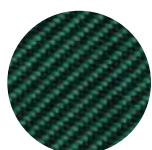

C211



C212



C213



C214



C215



C216

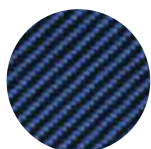

C217

- COLLECTION / COLLEZIONE
kvadrat - RELATE
DESIGNER Patricia Urquiola

- FLAME RESISTANCE / RESISTENZA AL FUOCO
AS/NZS 3837, class 2
BS 5852 Crib 5
BS 5852 Part 1 with treatment
DIN 4102 B1
EN 1021-1/2
IMO FTP Code 2010: Part 8
NF D60-013
NF P92 507 M1
NFPA 701
ÖNORM B1/Q1
SN 198 898 5.2
UNI 9175 Classe 1 IM
UNI 9177 Classe 1
US CA TB 117-2013

Category D

Fire retardant fabric / Tessuto ignifugo



D40



D41

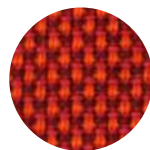

D42



D43

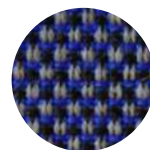

D44

- FLAME RESISTANCE /
RESISTENZA AL FUOCO
BS EN 1021 1&2
BS 5852 Part 1 0, 1
UNI 9175 Classe 1 IM
US CA TB 117-2013

Category E

Velvet / Velluto

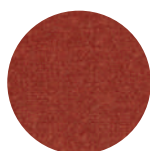

E01



E06

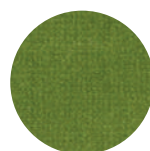

E02

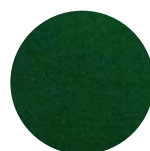

E07



E08

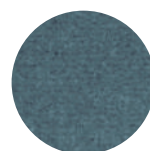

E04

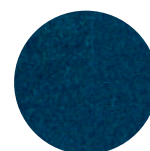

E03

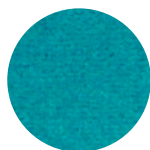

E05



E09

• COLLECTION / COLLEZIONE
DEDAR - ADAMO & EVA
MILANO

Category G

Fire retardant wool / Lana ignifuga

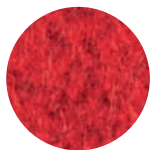

G21

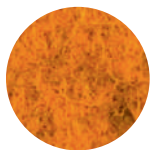

G22



G23



G24

- COLLECTION / COLLEZIONE

kvadrat - DIVINA MELANGE
DESIGNER Finn Skødt

- FLAME RESISTANCE / RESISTENZA AL FUOCO

AS/NZS 1530.3
ASTM E84 Class B Unadhered
ASTM E84 Class A Adhered
BS 5852 Part 1
BS 5867 part 2 type B
CAN ULC S109 with treatment
EN 1021-1/2
EN 13501, B-s2, d0 with treatment
IMO FTP Code 2010: Part 8
NF D60-013
NFPA 260
NFPA 701 with treatment
ÖNORM B1/ Q1
SN 198 898 5.3 with treatment
UNI 9175 Classe 1 IM
US CA TB 117-2013

Fire retardant wool / Lana ignifuga

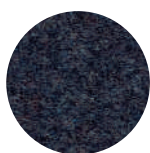

G110

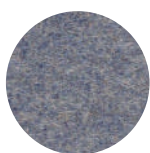

G111

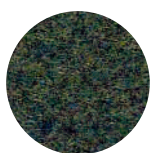

G112

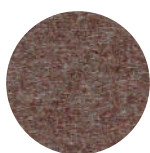

G113



G114



G115



G116

- COLLECTION / COLLEZIONE

kvadrat - DIVINA MD
DESIGNER Finn Skødt

- FLAME RESISTANCE / RESISTENZA AL FUOCO

AS/NZS 1530.3
ASTM E84 Class B Unadhered
ASTM E84 Class A Adhered
BS 5852 Crib 5 with treatment
BS 5852 Part 1
BS 5867 part 2 type B
CAN ULC S109 with treatment
EN 1021-1/2
EN 13501, B-s2, d0 with treatment
IMO FTP Code 2010: Part 8
NF D60-013
NFPA 260
NFPA 701 with treatment
ÖNORM B1/ Q1
SN 198 898 5.3 with treatment
UNI 9175 Classe 1 IM
US CA TB 117-2013

Colours are indicative. Pedrali reserves the right to modify or upgrade the product without prior notice.
I colori sono indicativi. Pedrali si riserva la facoltà di apportare modifiche o migliorie senza alcun preavviso.

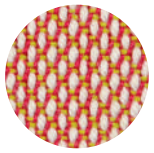

G59

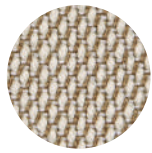

G66

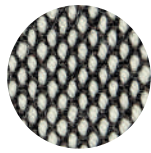

G63

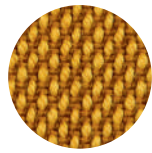

G67

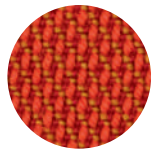

G69

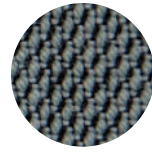

G62

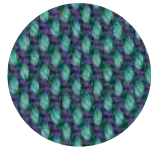

G68

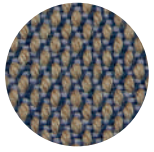

G64



G65

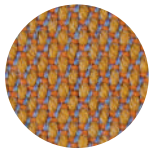

G190

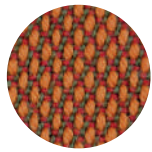

G191

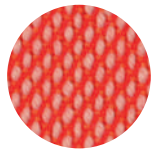

G192

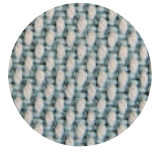

G193

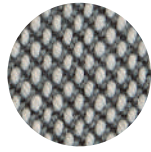

G194

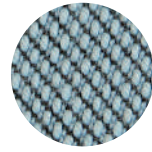

G195

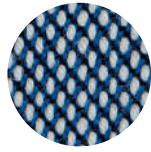

G196

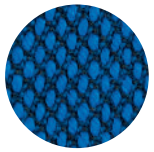

G197



G71

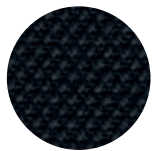

G70

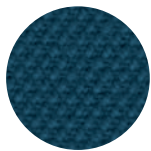

G75

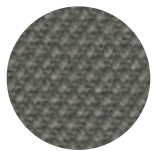

G73

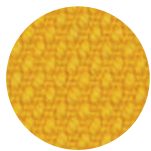

G78

• COLLECTION / COLLEZIONE

kvadrat

STEELCUT TRIO

G59+G69; G190+G197

STEELCUT

G70+G78

DESIGNERS Dijkmeijer & Ridolfo

• FLAME RESISTANCE / RESISTENZA AL FUOCO

AS/NZS 1530.3

BS 5852 Part 1

BS 5852 Crib 5 with treatment

EN 1021 – 1/2

IMO FTP Code 2010: Part 8

NF D60-013

NFPA 260

SN 198 898 5.3 with treatment

UNI 9175 Classe 1 IM

US CA TB 117-2013

for G59+G69; G190+G197:

AS/NZS 3837 Class 2

BS 5852 IGNITION SOURCE 3

GB 50222 B1 with treatment

ÖNORM B1/Q1

Fire retardant fabric / Tessuto ignifugo

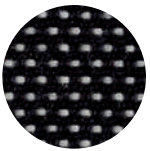

G100

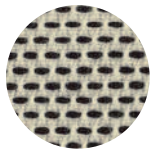

G101

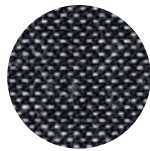

G102

- COLLECTION / COLLEZIONE

kvadrat - BASEL

DESIGNERS Herzog & de Meuron

- FLAME RESISTANCE / RESISTENZA AL FUOCO

AS/NZS 3837 Class 2
BS 5852 Part 1
BS 5852 Crib 5 with treatment
EN 1021 - 1/2
GB 50222 B1 with treatment
IMO FTP Code 2010: Part 8

NFPA 260
NF D60-013
ÖNORM B1/Q1
SN 198 898 5.3 with treatment
UNI 9175 Classe 1 IM
US CA TB 117-2013

Fire retardant fabric / Tessuto ignifugo



G120



G121

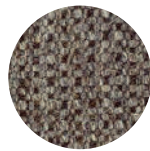

G122

- COLLECTION / COLLEZIONE

kvadrat - MOLLY

DESIGNER Åsa Pärson

- FLAME RESISTANCE / RESISTENZA AL FUOCO

BS 5852 Part 1
BS 5852 Crib 5 with treatment
EN 1021 - 1/2
IMO FTP Code 2010: Part 8

NFPA 260
NF D60-013
ÖNORM B1/Q1
UNI 9175 Classe 1 IM
US CA TB 117-2013

Fire retardant fabric / Tessuto ignifugo

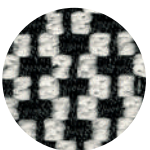

G130

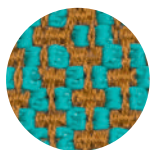

G131



G132

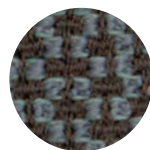

G133

- FLAME RESISTANCE / RESISTENZA AL FUOCO

BS 5852:1979 (Part 1)
BS 5852:2006 (Part 2) Crib 5
DIN 4102-1 B2
EN 1021 -1 and -2
EN 13501-1
FAR 25.853 (12 sec. vertical)
IMO: 2014/90/EU (MED)
UNI 9175 Classe 1 IM
US CA TB 117-2013



Fire retardant fabric / Tessuto ignifugo

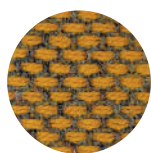

G140

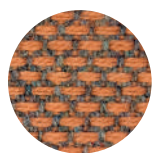

G141

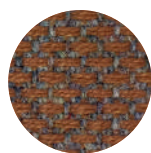

G142

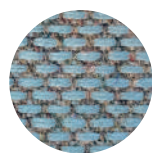

G143



G144

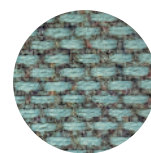

G145



G146

- COLLECTION / COLLEZIONE

kvadrat - RE-WOOL

DESIGNER Margrethe Odgaard

- FLAME RESISTANCE / RESISTENZA AL FUOCO

AS/NZS 1530.3

AS/NZS 3837 Class 2

BS 5852 Part 1

BS 5852 Crib 5 with treatment

BS 5852 IGNITION SOURCE 3

EN 1021 - 1/2

IMO FTP Code 2010: Part 8

NF D60-013

ÖNORM B1/Q1

UNI 9175 Classe 11M

US CA TB 117-2013



Fire retardant fabric / Tessuto ignifugo

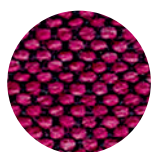

G150

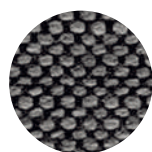

G151

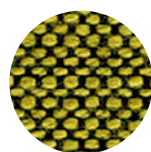

G152

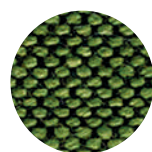

G153

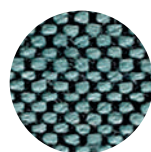

G154

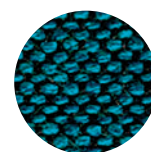

G155

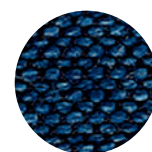

G156

- COLLECTION / COLLEZIONE

 **svensson** - BALANCE

- FLAME RESISTANCE / RESISTENZA AL FUOCO

BS 5852 Crib 5

EN ISO 1021 Part 1&2

IMO FTP Code 2010: Part 8

UNI 9175 Classe 1 IM

US CA TB 117-2013



Fire retardant fabric / Tessuto ignifugo

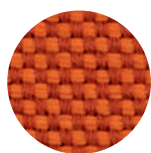

G170

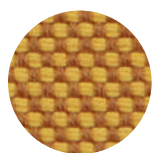

G171

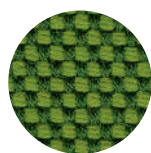

G172

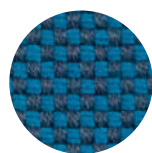

G173

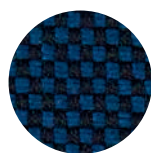

G174

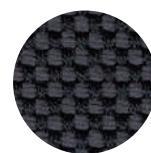

G175

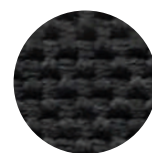

G176



G210



G211

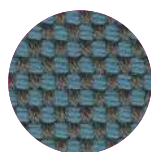

G212

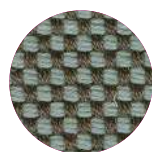

G213

- FLAME RESISTANCE / RESISTENZA AL FUOCO

BS 5852:1979 (Part 1)

BS 5852:2006 (Part 2) Crib 5

DIN 4102-1 B2

EN 13501-1

EN 1021 -1 and -2

FAR 25.853 (12 sec. vertical)

IMO: 2014/90/EU (MED)

UNI 9175 Classe 1 IM

US CA TB 117-2013

Colours are indicative. Pedrali reserves the right to modify or upgrade the product without prior notice.
I colori sono indicativi. Pedrali si riserva la facoltà di apportare modifiche o migliorie senza alcun preavviso.

Fire retardant fabric / Tessuto ignifugo



G200



G201



G202



G203

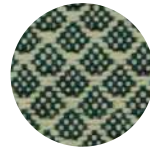

G204

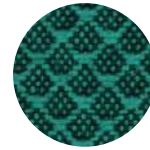

G205

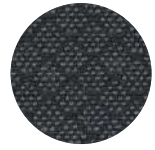

G206

- COLLECTION / COLLEZIONE
kvadrat - JAALI
DESIGNER Doshi Levien

- FLAME RESISTANCE / RESISTENZA AL FUOCO
AS/NZS 1530.3
BS 5852 Part 1
BS 5852 Crib 5 with treatment
BS 5852 IGNITION SOURCE 3
EN 1021-1/2

IMO FTP Code 2010: Part 8
NF D60-013
SN 198 898 5.3 with treatment
UNI 9175 Classe 1IM
US CA TB 117-2013

Fire retardant fabric / Tessuto ignifugo



G220

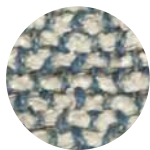

G221



G222



G223



G224



G225

- COLLECTION / COLLEZIONE
kvadrat - SAHCO
MOSS
DESIGNER Vincent Van Duysen

- FLAME RESISTANCE / RESISTENZA AL FUOCO
BS 5852 Part 1
BS 5852 Crib 5 with treatment
EN 1021-1/2
US CA TB 117-2013

Fire retardant fabric / Tessuto ignifugo



G07

- FLAME RESISTANCE / RESISTENZA AL FUOCO
BS EN 1021 1&2
BS EN 1021-1
ÖNORM A3800-B2-B3825-Q1 UK
NFP 92-503 M3
US CA TB 117-2013

Fire retardant fabric / Tessuto ignifugo



G160



G161

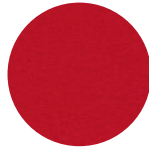

G162



G163



G164

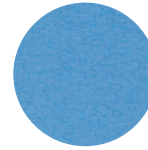

G165



G166



G167



G168



G169

- COLLECTION / COLLEZIONE
kvadrat - HERO
DESIGNER Patricia Urquiola

- FLAME RESISTANCE /
RESISTENZA AL FUOCO
AS/NZS 3837 Class 2
BS 5852 Crib 5 with treatment
BS 5852 Part 1
EN 1021 - 1/2
IMO FTP Code 2010: Part 7
with treatment
IMO FTP Code 2010: Part 8
NF D60-013
SN 198 898 5.3 with treatment
UNI 9175 Classe 1 IM
US CA TB 117-2013

Fire retardant velvet / Velluto ignifugo



G180



G181

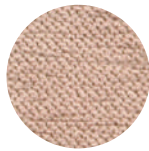

G182

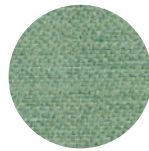

G183

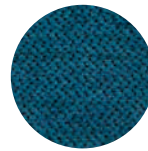

G184

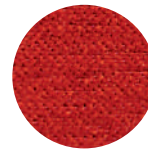

G185

- COLLECTION / COLLEZIONE
kvadrat - STILL
DESIGNER Georgina Wright

- FLAME RESISTANCE / RESISTENZA AL FUOCO
ASTM E84 Class A
BS 5852 Crib 5
BS 5852 Part 1
BS 5867 Part 2 type B
DIN 4102 B1
EN 1021-1/2
EN 13501-1, B-s1, d0
IMO FTP Code 2010:Part 8
NF D60-013
NF P92 507 M1
NFPA 701
ÖNORM B1/Q1
SN 198 898 5.2
UNI 9175 Classe 1 IM
UNI 9177 Classe 1
US CA TB 117-2013

Velvet / Velluto



G230



G231



G232



G233



G234

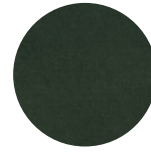

G235



G236



G237

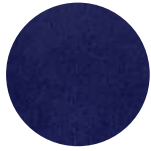

G238



G239

- **FLAME RESISTANCE / RESISTENZA AL FUOCO**
BS 5852 Part 1
US CA TB 117-2013

Category H

Fire retardant simil leather / Finta pelle ignifuga



H82



H85



H87

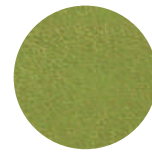

H89

- **FLAME RESISTANCE / RESISTENZA AL FUOCO**
BS 5852-1 cigarette test
BS 5852-1 match test
BS 5852 crib 5
EN 1021-1
EN 1021-2
IMO FTP CODE 2010
US CA TB 117:2013
UNI 9175 classe 1IM

Fire retardant simil leather / Finta pelle ignifuga



- **FLAME RESISTANCE / RESISTENZA AL FUOCO**
 BS 5852 Crib 5
 BS 5852 Part 1-2
 EN 1021 Part 1-2
 IMO resolution FTP Code 2010
 IMO resolution A.652 (16):1989
 UNI 9175 Classe 1 IM
 US CA TB 117-2013

Fire retardant fabric / Tessuto ignifugo

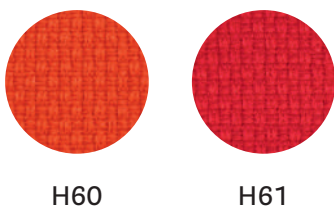

- **FLAME RESISTANCE / RESISTENZA AL FUOCO**
 BS EN 1021 1&2
 BS EN 1021-1
 BS 5852 Part 1 0, 1
 UNI 9175 Classe 1 IM
 US CA TB 117-2013

Colours are indicative. Pedrali reserves the right to modify or upgrade the product without prior notice.
 I colori sono indicativi. Pedrali si riserva la facoltà di apportare modifiche o migliorie senza alcun preavviso.



Fire retardant fabric / Tessuto ignifugo

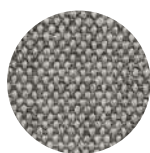

H120

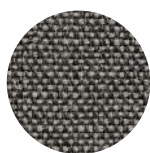

H121

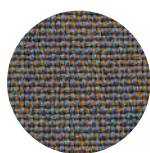

H122



H123



H124



H125



H126

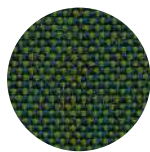

H127

• COLLECTION / COLLEZIONE
kvadrat - REMIX 3
DESIGNER Giulio Ridolfo

• FLAME RESISTANCE / RESISTENZA AL FUOCO
AS/NZS 1530.3
AS/NZS 3837, class 2
ASTM E84 Class A
BS 5852 Crib 5 with treatment
BS 5852 IGNITION SOURCE 3
BS 5852 Part 1
EN 1021 - 1/2
GB 50222 B1 with treatment
IMO FTP Code 2010: Part 7
with treatment
IMO FTP Code 2010: Part 8
NF D60-013
NFPA 260
ÖNORM B1/Q1
SN 198 898 5.3 with treatment
UNI 9175 Classe 1 IM
US CA TB 117-2013



Fire retardant velvet / Velluto ignifugo



H41



H40



H44



H45



H46

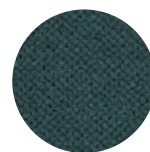

H51

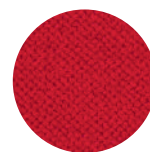

H53

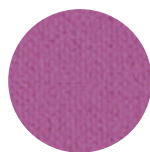

H52

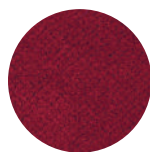

H42



H47

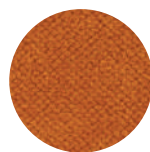

H48

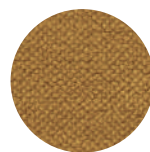

H43

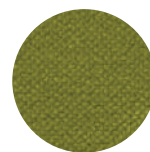

H49

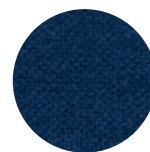

H50

• FLAME RESISTANCE / RESISTENZA AL FUOCO
BS 5852 Part 0,1
DIN 4102 B1
EN 1021-1&2
IMO MSC 307(88) Annex 1 Part 7-8

NF P 92-503-507 M1
NFPA 260:2019
UNI 9177 Classe 1
UNI 9175 Classe 1 IM
US CA TB 117-2013

Colours are indicative. Pedrali reserves the right to modify or upgrade the product without prior notice.
I colori sono indicativi. Pedrali si riserva la facoltà di apportare modifiche o migliorie senza alcun preavviso.

Category N

Fire retardant fabric / Tessuto ignifugo



N06



N07



N05



N08

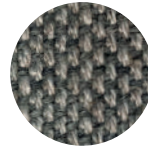

N01



N02

- COLLECTION / COLLEZIONE

kvadrat - SUNNIVA

DESIGNER Raf Simons & Fanny Aronsen

- FLAME RESISTANCE / RESISTENZA AL FUOCO

AS/NZS 3837, class 2

BS 5852 Part 1 with treatment

BS 5852 Crib 5 with treatment

EN 1021 – 1/2

NFPA 260

US CA TB 117-2013

IMO FTP Code 2020: Part 8 with treatment

Fabric / Tessuto



N30



N31



N32

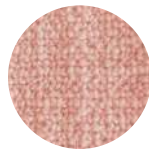

N33

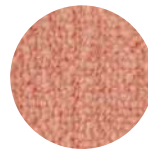

N34

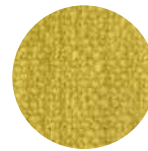

N35

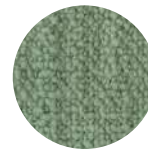

N36

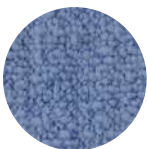

N37



N38

- FLAME RESISTANCE / RESISTENZA AL FUOCO

BS 5852-1 cigarette test

BS 5852-1 match test

BS 5852 Crib 5

US CA TB 117-2013

Colours are indicative. Pedrali reserves the right to modify or upgrade the product without prior notice.
I colori sono indicativi. Pedrali si riserva la facoltà di apportare modifiche o migliorie senza alcun preavviso.

Category P

Mid grain leather / Pelle mezzo fiore

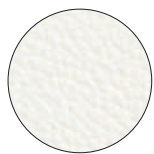

PBI



PLA



PSA



PGC

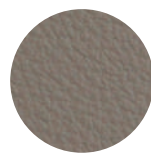

PGA

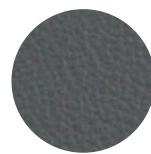

PGR



PBE



PTA

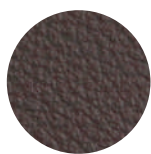

PMA



PNE



PRO



PTE



PGN

- COLLECTION / COLLEZIONE



- FLAME RESISTANCE / RESISTENZA AL FUOCO

BS 5852:1979
BS EN 1021-1-2:2006
IMO RES A652 (16)
US CA TB 117-2013

PEDRALI PRICELIST | Edition February 2023

Copyright © 2023, Pedrali S.p.A. All rights reserved



Weights, measurements and colours are indicative. Pedrali reserves the right to modify or upgrade the products without prior notice.

Pesi, dimensioni e colori sono indicativi. Pedrali si riserva la facoltà di apportare modifiche o migliorie senza alcun preavviso.

Industrial property right | Diritto di proprietà industriale

Pedrali's Collections are worldwide protected by the industrial property right and patents.

Tutte le collezioni Pedrali sono protette nel mondo dal diritto di proprietà industriale e da brevetti registrati.

